

SCPI Programming Manual

S331E, S332E, S361E, S362E

Site Master™

MS2711E, MS2712E, MS2713E

Spectrum Master™

MT8212E, MT8213E

Cell Master™

Note

SCPI programming commands may not be available for all instrument operating modes and functions.

The Anritsu logo consists of the word "Anritsu" in a bold, sans-serif font. The letter "A" is stylized with a diagonal slash through it. The logo is positioned in the bottom right corner of the page.

Table of Contents

Chapter 1—General Information

1-1	About this Manual	1-1
1-2	Introduction	1-1
1-3	Contacting Anritsu	1-1
1-4	Remote Programming Setup and Interface	1-2
	Ethernet Interface Connection and Setup	1-2
	USB Interface Connection and Setup	1-4
1-5	Sending SCPI Commands	1-7

Chapter 2—Programming with SCPI

2-1	Introduction	2-1
2-2	Introduction to SCPI Programming	2-1
	SCPI Common Commands	2-2
	SCPI Required Commands	2-2
	SCPI Optional Commands	2-3
2-3	Subsystem Commands	2-4
	Command Names	2-4
	Hierarchical Command Structure	2-5
	Query Commands	2-6
	Identifiers	2-7
	Data Parameters	2-8
	Data Parameter Notations	2-9
	Unit Suffixes	2-9
2-4	Notational Conventions	2-10
2-5	Notational Examples	2-11
	Command Terminators	2-12
2-6	Formatting Conventions	2-12
2-7	Parameter Names	2-13
	Spectrum Analyzer Parameter Names	2-13
	Cable & Antenna Parameter Names	2-18
	GSM Parameter Names	2-22
	WiMAX, Mobile WiMAX Parameter Names	2-23
	WCDMA Parameter Names	2-25
	CDMA Parameter Names	2-27
	EVDO Parameter Names	2-29
	TDSCDMA Parameter Names	2-31

Table of Contents (Continued)

Chapter 3—All Mode Commands

3-1	:CONFigure Subsystem	3-1
3-2	:FETCh GPS Subsystem	3-3
3-3	:INSTRument Subsystem	3-5
3-4	:MMEMory Subsystem	3-7
3-5	[:SENSe] GPS Subsystem	3-10
3-6	:STATus Subsystem	3-11
3-7	:SYSTem Subsystem	3-12

Chapter 4—Cable & Antenna Commands

4-1	:CALCulate Subsystem	4-1
4-2	:CALibration Subsystem	4-11
4-3	:CONFigure Subsystem	4-12
4-4	:DISPlay Subsystem	4-15
4-5	:FORMat Subsystem	4-17
	Interpreting Returned Data Pair	4-18
4-6	:INITiate Subsystem	4-20
4-7	:MMEMory Subsystem	4-22
4-8	:SOURce Subsystem	4-26
4-9	:TRACe Subsystem	4-27
4-10	[:SENSe] Subsystem	4-28

Chapter 5—Spectrum Analyzer Commands

5-1	:ABORt Subsystem	5-1
5-2	:CALCulate Subsystem	5-2
5-3	:CONFigure Subsystem	5-22
5-4	:DISPlay Subsystem	5-24
5-5	:FETCh Subsystem	5-26
5-6	:FORMat Subsystem	5-28
5-7	:INITiate Subsystem	5-29
5-8	:MEASure Subsystem	5-31
5-9	:MMEMory Subsystem	5-34
5-10	:READ Subsystem	5-38
5-11	:TRACe Subsystem	5-40
5-12	:TRIGger Subsystem	5-46
5-13	:UNIT Subsystem	5-48
5-14	[:SENSe] Subsystem	5-49

Table of Contents (Continued)

Chapter 6—GSM Commands

6-1	:ABORt Subsystem	6-1
6-2	:CONFIgure Subsystem	6-2
6-3	:DISPly Subsystem	6-6
6-4	:FETCh Subsystem	6-7
6-5	:FORMat Subsystem	6-10
6-6	:INITiate Subsystem	6-11
6-7	:MEASure Subsystem	6-12
6-8	:MMEMory Subsystem	6-16
6-9	:READ Subsystem	6-20
6-10	:TRACe Subsystem	6-23
6-11	[:SENSe] Subsystem	6-24

Chapter 7—WCDMA Commands

7-1	:ABORt Subsystem	7-1
7-2	:CALCulate Subsystem	7-2
7-3	:CONFIgure Subsystem	7-4
7-4	:DISPly Subsystem	7-7
7-5	:FETCh Subsystem	7-8
7-6	:FORMat Subsystem	7-18
7-7	:INITiate Subsystem	7-19
7-8	:MEASure Subsystem	7-20
7-9	:MMEMory Subsystem	7-32
7-10	:READ Subsystem	7-35
7-11	:TRACe Subsystem	7-43
7-12	[:SENSe] Subsystem	7-45

Chapter 8—TDSCDMA Commands

8-1	:ABORt Subsystem	8-1
8-2	:CONFIgure Subsystem	8-2
8-3	:DISPly Subsystem	8-4
8-4	:FETCh Subsystem	8-5
8-5	:FORMat Subsystem	8-7
8-6	:INITiate Subsystem	8-8
8-7	:MEASure Subsystem	8-9
8-8	:MMEMory Subsystem	8-13

Table of Contents (Continued)

8-9	:READ Subsystem	8-16
8-10	:TRACe Subsystem	8-20
8-11	:UNIT Subsystem	8-23
8-12	[:SENSe] Subsystem	8-24

Chapter 9—CDMA Commands

9-1	:ABORt Subsystem	9-1
9-2	:CALCulate Subsystem	9-2
9-3	:CONFigure Subsystem	9-3
9-4	:DISPlay Subsystem	9-5
9-5	:FETCh Subsystem	9-6
9-6	:FORMat Subsystem	9-9
9-7	:INITiate Subsystem	9-10
9-8	:MEASure Subsystem	9-11
9-9	:MMEMory Subsystem	9-16
9-10	:READ Subsystem	9-19
9-11	:TRACe Subsystem	9-23
9-12	:TRIGger Subsystem	9-26
9-13	:UNIT Subsystem	9-27
9-14	[:SENSe] Subsystem	9-28

Chapter 10—EVDO Commands

10-1	:ABORt Subsystem	10-1
10-2	:CALCulate Subsystem	10-2
10-3	:CONFigure Subsystem	10-3
10-4	:DISPlay Subsystem	10-5
10-5	:FETCh Subsystem	10-6
10-6	:FORMat Subsystem	10-10
10-7	:INITiate Subsystem	10-11
10-8	:MEASure Subsystem	10-12
10-9	:MMEMory Subsystem	10-18
10-10	:READ Subsystem	10-21
10-11	:TRACe Subsystem	10-24
10-12	:TRIGger Subsystem	10-27
10-13	:UNIT Subsystem	10-28
10-14	[:SENSe] Subsystem	10-29

Table of Contents (Continued)

Chapter 11—Fixed WiMAX Commands

11-1	:ABORt Subsystem	11-1
11-2	:CONFigure Subsystem	11-2
11-3	:DISPlay Subsystem	11-5
11-4	:FETCh Subsystem	11-7
11-5	:FORMat Subsystem	11-10
11-6	:INITiate Subsystem	11-11
11-7	:MEASure Subsystem	11-12
11-8	:MMEMory Subsystem	11-16
11-9	:READ Subsystem	11-19
11-10	:TRACe Subsystem	11-22
11-11	[:SENSE] Subsystem	11-24

Chapter 12—Mobile WiMAX Commands

12-1	:ABORt Subsystem	12-1
12-2	:CONFigure Subsystem	12-2
12-3	:DISPlay Subsystem	12-5
12-4	:FETCh Subsystem	12-7
12-5	:FORMat Subsystem	12-10
12-6	:INITiate Subsystem	12-11
12-7	:MEASure Subsystem	12-12
12-8	:MMEMory Subsystem	12-16
12-9	:READ Subsystem	12-19
12-10	:TRACe Subsystem	12-22
12-11	[:SENSe] Subsystem	12-24

Chapter 13—LTE Commands

13-1	:ABORt Subsystem	13-1
13-2	:CALCulate Subsystem	13-2
13-3	:CONFigure Subsystem	13-6
13-4	:DISPlay Subsystem	13-10
13-5	:FETCh Subsystem	13-11
13-6	:FORMat Subsystem	13-16
13-7	:INITiate Subsystem	13-17
13-8	:MEASure Subsystem	13-18
13-9	:READ Subsystem	13-23

Table of Contents (Continued)

13-10 :UNIT Subsystem	13-28
13-11 [:SENSe] Subsystem	13-29

Chapter 14—AM/FM/PM Commands

14-1 :CALCulate Subsystem.	14-1
14-2 :DISPlay Subsystem	14-5
14-3 :FORMat Subsystem.	14-6
14-4 :INITiate Subsystem	14-8
14-5 :MMEMory Subsystem	14-9
14-6 :TRACe Subsystem	14-12
14-7 [:SENSe] Subsystem	14-13

Chapter 15—Tracking Generator Commands

15-1 :CONFigure Subsystem	15-1
15-2 :FETCh Subsystem.	15-3
15-3 :GENerator Subsystem.	15-4
15-4 :INITiate Subsystem	15-6
15-5 :MEASure Subsystem.	15-7
15-6 :READ Subsystem	15-8
15-7 [:SENSe] Subsystem	15-9

Appendix A—Example

A-1 C/C++	A-1
A-2 Visual Basic	A-3
A-3 LabVIEW™	A-4

Appendix B—List of Commands by Mode

Appendix C—List of Commands, Alphabetical

Chapter 1 — General Information

1-1 About this Manual

This SCPI Programming Manual provides information for remote operation of the following Anritsu instruments using commands sent from an external controller via Ethernet or USB connection:

- S331E, S332E, S361E, S362E Site Master
- MS2711E, MS2712E, MS2713E Spectrum Master
- MT8212E, MT8213E Cell Master

This Programming Manual includes the following:

- An overview of Ethernet and USB connection to the instrument.
- An overview of Standard Commands for Programmable Instruments (SCPI) command structure and conventions.
- The IEEE common commands that are supported by the instruments.
- A complete listing and description of all the SCPI commands that can be used to remotely control functions of the instrument. The commands are organized by measurement mode starting in [Chapter 3, “All Mode Commands”](#).

This manual is intended to be used in conjunction with the instrument User Guide:

- Site Master User Guide PN: 105800-00252
- Spectrum Master User Guide PN: 10580-00251
- Cell Master User Guide PN: 10580-00250

Refer to the instrument User Guide for general information about the instrument, including equipment setup and operating instructions.

1-2 Introduction

This chapter provides a general description of remote programming setup and interface connections using Ethernet or USB, and sending SCPI commands to the instrument.

1-3 Contacting Anritsu

To contact Anritsu, please visit:

<http://www.anritsu.com/contact-us>

From here, you can select the latest sales, select service and support contact information in your country or region, provide online feedback, complete a “Talk to Anritsu” form to have your questions answered, or obtain other services offered by Anritsu.

Updated product information can be found on the Anritsu website:

<http://www.anritsu.com/>

Search for the product model number. The latest documentation is on the product page under the Library tab.

1-4 Remote Programming Setup and Interface

Remote programming and operation of the instrument is accomplished via the Ethernet or the USB interface. The following sections provide information about the interface connections, cable requirements, and remote operation setup.

Note	<p>If a password has been set for the instrument, to control access via the Anritsu Web Remote Tools, for example, remote operation using SCPI commands is not possible.</p> <p>Ethernet connection requires the Ethernet option. Refer to your instrument data sheet for a listing of standard and optional features available for order.</p>
-------------	--

Ethernet Interface Connection and Setup

The S3xxE, MS271xE, MT821xE uses Ethernet to communicate remotely with a controller. Most instrument functions (except power on/off) can be controlled via an Ethernet connection to a PC connected directly (with an Ethernet cross-over cable) or through a network. The instrument software supports the TCP/IP network protocol.

Ethernet networking uses a bus or star topology in which all of the interfacing devices are connected to a central cable called the bus, or are connected to a hub. Ethernet uses the CSMA/CD access method to handle simultaneous transmissions over the bus. CSMA/CD stands for *Carrier Sense Multiple Access/Collision Detection*. This standard enables network devices to detect simultaneous data channel usage, called a *collision*, and provides for a contention protocol. When a network device detects a collision, the CSMA/CD standard dictates that the data is retransmitted after waiting a random amount of time. If a second collision is detected, the data is again retransmitted after waiting twice as long. This is known as exponential back off.

The TCP/IP setup requires the following:

- **IP Address:** Every computer and electronic device in a TCP/IP network requires an IP address. An IP address has four numbers (each between 0 and 255) separated by periods. For example: 128.111.122.42 is a valid IP address.
- **Subnet Mask:** The subnet mask distinguishes the portion of the IP address that is the network ID from the portion that is the station ID. The subnet mask 255.255.0.0, when applied to the IP address given above, would identify the network ID as 128.111 and the station ID as 122.42. All stations in the same local area network should have the same network ID, but different station IDs.
- **Default Gateway:** A TCP/IP network can have a gateway to communicate beyond the LAN identified by the network ID. A gateway is a computer or electronic device that is connected to two different networks and can move TCP/IP data from one network to the other. A single LAN that is not connected to other LANs requires a default gateway setting of 0.0.0.0. If you have a gateway, then the default gateway would be set to the appropriate value of your gateway.
- **Ethernet Address:** An Ethernet address is a unique 48-bit value that identifies a network interface card to the rest of the network. Every network card has a unique Ethernet address (MAC address) permanently stored into its memory.

Interface between the instrument and other devices on the network is via a category five (CAT-5) interface cable connected to a network. This cable uses four twisted pairs of insulated copper wires terminated into an RJ45 connector. CAT-5 cabling is capable of supporting frequencies up to 100 MHz and data transfer speeds up to 1 Gbps, which accommodates 1000Base-T, 100Base-T, and 10Base-T networks. CAT-5 cables are based on the EIA/TIA 568 Commercial Building Telecommunications Wiring Standard developed by the Electronics Industries Association. A pinout diagram is shown in [Table 1-1](#).

Table 1-1. 8-pin Ethernet RJ45 Connector Pinout Diagram

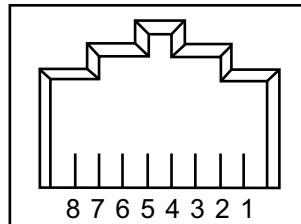

Pin	Name	Description	Wire Color
1	TX+	Transmit data (> +3 volts)	White/Orange
2	TX-	Transmit data (< -3 volts)	Orange
3	RX+	Receive data (> +3 volts)	White/Green
4	-	Not used (common mode termination)	Blue
5	-	Not used (common mode termination)	White/Blue
6	RX-	Receive data (< -3 volts)	Green
7	-	Not used (common mode termination)	White/Brown
8	-	Not used (common mode termination)	Brown

TCP/IP connectivity requires setting up the parameters described at the beginning of this section. The following is a brief overview of how to set up a general LAN connection on the S3xxE, MS271xE, MT821xE.

Note

You may need to consult your network documentation or network administrator for assistance in configuring your network setup.

LAN Connection

The RJ45 connector is used to connect the instrument to a local area network. Integrated into this connector are two LEDs. The amber LED indicates the presence of LAN voltages (a live LAN connection) while the green LED flashes to show that LAN traffic is present. The instrument IP address is set by pressing the **Shift** key, then the **System** (8) key followed by the **System Options** soft key and the **Ethernet Config** soft key. The instrument IP address can be set automatically using DHCP, or manually by entering the desired IP address, gateway address and subnet mask.

Note

An active Ethernet cable must be connected to the instrument before it is turned on in order to enable the Ethernet port for DHCP or for a static IP address.

Depending on local conditions, the port may remain enabled when changing from DHCP to static IP address, when changing from static IP address to DHCP, or when temporarily disconnecting the Ethernet cable.

If the port becomes disabled, verify that an active Ethernet cable is attached to the instrument, then cycle the power off and back on.

Dynamic Host Configuration Protocol (DHCP) is an Internet protocol that automates the process of setting IP addresses for devices that use TCP/IP, and is the most common method of configuring a device for network use.

To determine if a network is set up for DHCP, connect the instrument to the network and select DHCP protocol in the Ethernet Config menu. Power cycle the instrument. If the network is set up for DHCP, the assigned IP address should be displayed briefly after the power-up sequence.

To display the IP address of the instrument, press the **Shift** key followed by **System** (8), then the System Options soft key and Ethernet Config.

USB Interface Connection and Setup

The Universal Serial Bus (USB) architecture is a high-performance networking standard that is considered “plug and play” compatible. The USB driver software is automatically detected and configured by the operating system of the devices that are connected to the bus. The instrument conforms to the USB 2.0 standard and is a USB “full-speed” device that supports data rates of up to 10 Mbps with the following restrictions:

- One USB network can support up to 127 devices.
- The maximum length of USB cables between active devices is 5 meters for USB 2.0 and 3 meters for USB 1.0.

You must have NI-VISA 2.5 or later installed on the controller PC and you must select the VISA library (visa32.dll) as a reference in a Visual Basic project. For remote USB control, the controlling PC must have a version of VISA installed that supports USBTMC (USB Test and Measurement Class) devices.

The USB 2.0 Mini-B device connector can be used to connect the instrument directly to a PC. The first time the instrument is connected to a PC, the normal USB device detection by the computer operating system takes place.

1. Power on the instrument and controller PC and wait for the systems to power up completely.
2. Connect the USB cable Mini-B connector to the instrument.

3. Connect the USB cable A connector to the controller PC USB host port. The controller PC should indicate “New Hardware Found” if the combination of USB VID/PID/Serial Number has never been connected to this controller PC.



Figure 1-1. Found New Hardware Wizard

4. Select to allow the Wizard to search for and install the USB software automatically.

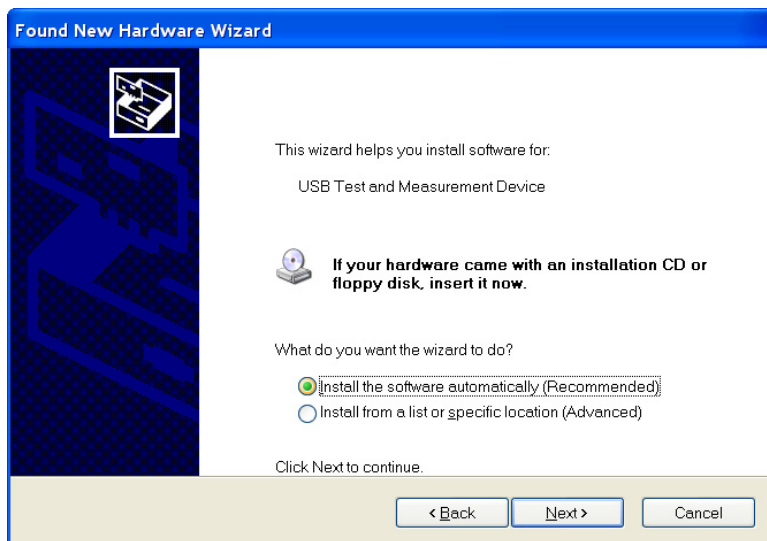

Figure 1-2. Found New Hardware Wizard

5. After the software finishes installing, close the Wizard by clicking Finish.



Figure 1-3. Found New Hardware Wizard

1-5 Sending SCPI Commands

SCPI commands can be sent to the instrument through any Virtual Instrument Software Architecture (VISA) controller. VISA is a commonly used API in the Test and Measurement industry for communicating with instruments from a PC. The physical connection between the PC and the instrument can be Ethernet or USB. NI-VISA is the National Instruments implementation of the VISA I/O standard. Information and downloads are available at <http://www.ni.com/visa/>

The following example describes the verification that a VISA controller can interact with the instrument. The images shown and the instructions for your instrument and software may differ from the examples.

Note Before remote operation, confirm that the instrument is not in the Menu screen. Sending commands while this screen is displayed is an invalid operation. Refer to the instrument User Guide for information on the Menu screen.

1. On the PC, run VISA Interactive Control and double-click on the instrument.

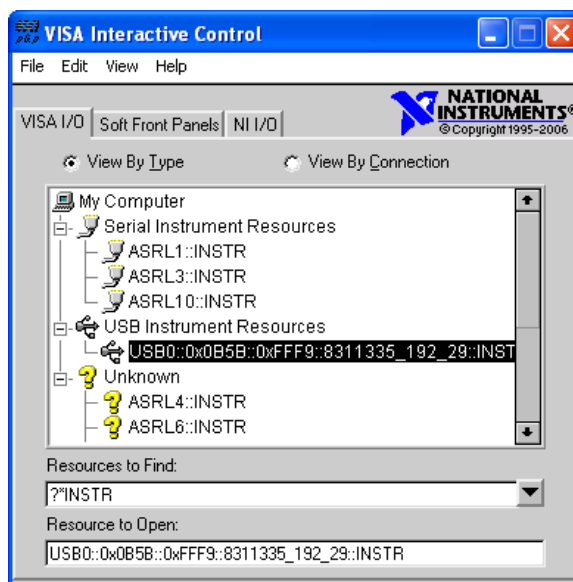

Figure 1-4. VISA Interactive Control

2. Select the viWrite tab and execute the default *IDN? \n write by clicking the Execute button.

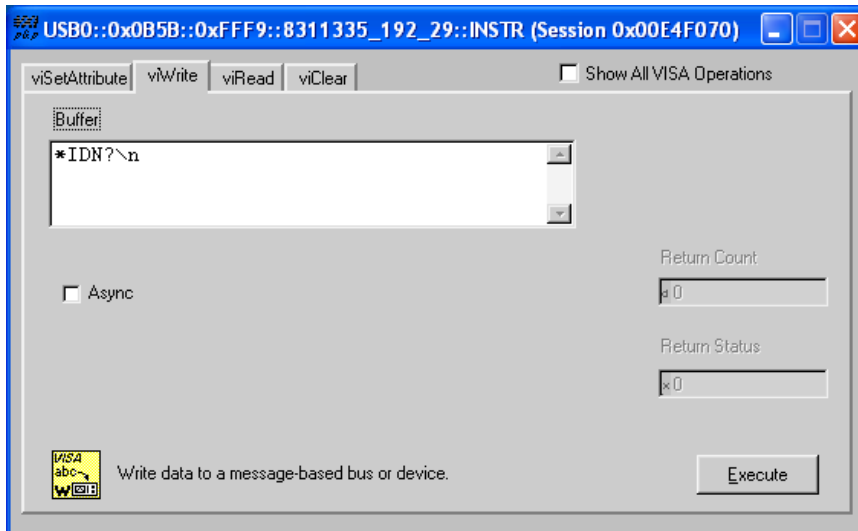

Figure 1-5. VISA Interactive Control viWrite Tab

3. Select the viRead tab and click the Execute button. If the PC is connected to the instrument, the command returns the following information from the Buffer: manufacturer name ("Anritsu"), model number/options, serial number, and firmware package number.

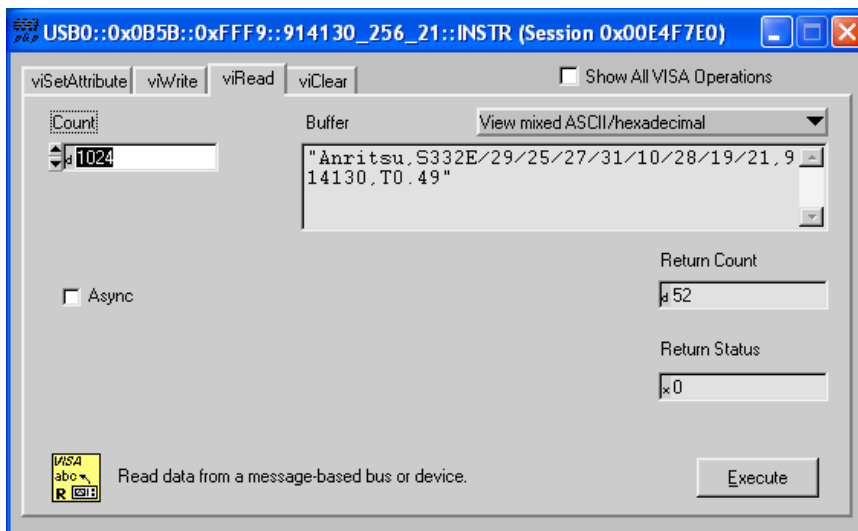

Figure 1-6. VISA Interactive Control viRead Tab

Chapter 2 — Programming with SCPI

2-1 Introduction

This chapter provides an introduction to Standard Commands for Programming Instruments (SCPI) programming that includes descriptions of the command types, hierarchical command structure, command subsystems, data parameters and notational conventions.

2-2 Introduction to SCPI Programming

Anritsu instruments can be operated with the use of SCPI commands. SCPI is intended to give the user a consistent environment for program development. It does so by defining controller messages, instrument responses, and message formats for all SCPI compatible instruments. SCPI commands are messages to the instrument to perform specific tasks. The command set includes:

- [“SCPI Common Commands” on page 2-2](#)
- [“SCPI Required Commands” on page 2-2](#)
- [“SCPI Optional Commands” on page 2-3](#)

SCPI Common Commands

Some common commands are defined in the IEEE-488.2 standard and must be implemented by all SCPI compatible instruments. These commands are identified by the asterisk (*) at the beginning of the command keyword. These commands are defined to control instrument status registers, status reporting, synchronization, and other common functions. The common commands supported by the instrument are shown below.

*IDN?

Title: Identification Query

Description: This command returns the following information in <string> format separated by commas: manufacturer name (“Anritsu”), model number/options, serial number, firmware package number. The model number and options are separated by a “/” and each option is separated by a “/”.

For example, the return string might look like:

```
"Anritsu,MT8212E/3/2,62011032,1.23"
```

*RST

Title: Reset

Description: This command restores parameters in the current application as well as system settings to their factory default values.

System settings affected by this command are Ethernet configuration, language, volume and brightness. Note that the unit will power cycle after this command is executed.

After executing this command, communication will be lost. Wait a minimum of 60 seconds before re-establishing communication.

Note

If the instrument does not operate correctly, this command can be used to restore the instrument to the original default settings and running condition.

Front Panel

Access: Shift-8 (System), System Options, Reset, Factory Defaults

See Also: :SYSTem:PRESet

SCPI Required Commands

The required SCPI commands supported by the instrument are listed in the [Table 2-1](#). These command work in all measurement modes and are described in [Chapter 3 on page 3-1](#).

Table 2-1. SCPI Required Commands

:STATus

:SYSTem

SCPI Optional Commands

Table 2-2 lists the optional SCPI commands that comprise the majority of the command set described in this document. These commands control most of the programmable functions of the instrument.

Table 2-2. SCPI Optional Commands

:ABORt	:FETCh	:MEASure	:TRACe
:CALCulate	:FORMat	:MMEMory	:TRIGger
:CALibration	:INITiate	:READ	:UNIT
:CONFigure	:INPut	:SENSe	: [SENSe]
:DISPlay	:INSTrument	:SOURce	

The SCPI optional commands are sorted by measurement modes and commands may be repeated in more than one mode.

- [Chapter 3, “All Mode Commands”](#)
- [Chapter 4, “Cable & Antenna Commands”](#)
- [Chapter 5, “Spectrum Analyzer Commands”](#)
- [Chapter 6, “GSM Commands”](#)
- [Chapter 7, “WCDMA Commands”](#)
- [Chapter 8, “TDSCDMA Commands”](#)
- [Chapter 9, “CDMA Commands”](#)
- [Chapter 10, “EVDO Commands”](#)
- [Chapter 11, “Fixed WiMAX Commands”](#)
- [Chapter 12, “Mobile WiMAX Commands”](#)
- [Chapter 13, “LTE Commands”](#)
- [Chapter 14, “P25 Commands”](#)
- [Chapter 15, “NXDN Commands”](#)
- [Chapter 14, “AM/FM/PM Commands”](#)
- [Chapter 15, “Tracking Generator Commands”](#)

2-3 Subsystem Commands

Subsystem commands control all instrument functions and some general purpose functions. All subsystem commands are identified by the colon used between keywords, as in `:INITiate:CONTinuous`.

The following information is provided for each subsystem command described in the following chapters.

- The command name, see “[Command Names](#)” on page 2-4.
- The path from the subsystem root command, see “[Hierarchical Command Structure](#)” on page 2-5.
- The query form of the command (if applicable), see “[Query Commands](#)” on page 2-6.
- The command title
- A description of the purpose of the command.
- The data parameters used as arguments for the command, see “[Data Parameters](#)” on page 2-8. This may include the parameter type and the available parameter choices.

Command Names

Typical SCPI commands consist of one or more keywords, parameters, and punctuation. SCPI command keywords can be a mixture of upper and lower case characters. Except for common commands, each keyword has a long and a short form. In this manual, the long form is presented with the short form in upper case and the remainder in lower case. For example, the long form of the command keyword to control the instrument display is `:DISPlay`.

The short form keyword is usually the first four characters of the long form (example: `DISP` for `DISPlay`). The exception to this is when the long form is longer than four characters and the fourth character is a vowel. In such cases, the vowel is dropped and the short form becomes the first three characters of the long form. Example: the short form of the keyword `:POWer` is `:POW`.

Some command keywords may have a numeric suffix to differentiate between multiple instrument features such as multiple trace options. For example; keywords `:TRACe[:DATA]{1|2|3}`, `:TRACe1`, or `:TRACe3`.

Note

In the previous paragraph, `:TRACe` is identical to `:TRACe1`. If a numeric suffix is not included in a command, the first option is implied. Curly brackets `{ }` designate optional keyword parameters. Square brackets `[]` designate optional command keywords.

As with any programming language, the exact command keywords and command syntax must be used. The syntax of the individual commands is described in detail in the programming command chapters. Unrecognized versions of long form or short form commands, or improper syntax, will generate an error.

Long Format vs. Short Format

Each keyword has a long format and a short format. The start frequency can be specified by `:SENSE:FREQUENCY:START` or `:SENS:FREQ:STAR`. The capital letters in the command specification indicate the short form of the command. A mixture of the entire short form elements with entire long form elements of each command is acceptable. For example, `:SENS:FREQUENCY:STAR` is an acceptable form of the command. However, `:SENS:FREQUen:STA` is not an acceptable form of the command because `:FREQUen` is not the entire short or long form of the command element.

Hierarchical Command Structure

All SCPI commands, except the common commands, are organized in a hierarchical structure similar to the inverted tree file structure used in most computers. The SCPI standard refers to this structure as “the Command Tree.” The command keywords that correspond to the major instrument control functions are located at the top of the command tree. The root command keywords for the SCPI command set are shown in [Figure 2-1](#).

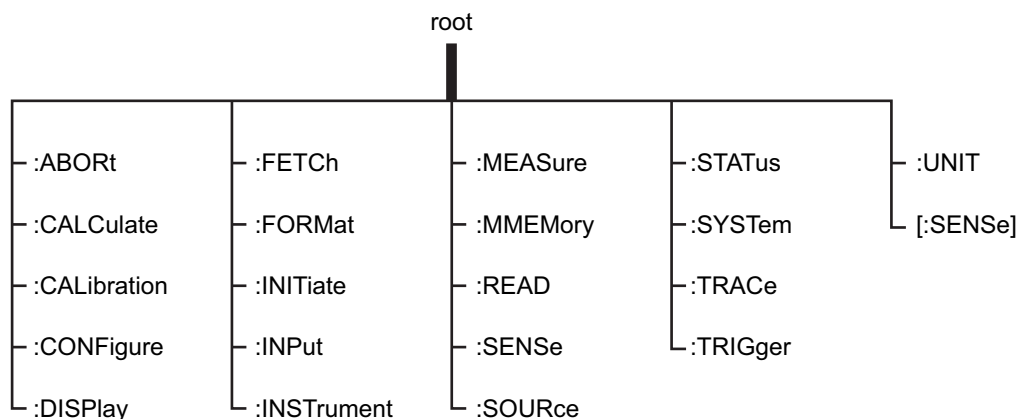

Figure 2-1. SCPI Command Tree

All instrument SCPI commands, except the `:ABORT` command, have one or more subcommands (keywords) associated with them to further define the instrument function to be controlled. The subcommand keywords may also have one or more associated subcommands (keywords). Each subcommand level adds another layer to the command tree. The command keyword and its associated subcommand keywords form a portion of the command tree called a command subsystem. The `:CONFigure` command subsystem is shown in [Figure 2-2](#).

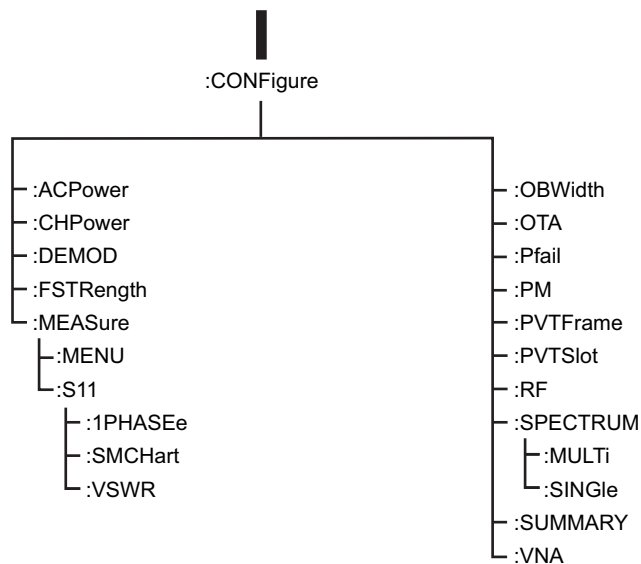

Figure 2-2. SCPI :CONFigure Subsystem

A colon (:) separates each subsystem. For example, the command `:SENSe:FREQuency:START <freq>` sets the start frequency. The start frequency is part of the `:FREQuency` subsystem which is part of the `:SENSe` subsystem. Stop frequency is also part of the `:SENSe:FREQuency` subsystem. It is specified by `:SENSe:FREQuency:STOP`.

Query Commands

All commands, unless specifically noted in the commands syntax descriptions, have a query form. As defined in IEEE-488.2, a query is a command with a question mark symbol appended (examples: `*IDN?` and `:OPTions?`). When a query form of a command is received, the current setting associated with the command is placed in the output buffer. Query commands always return the short form of the parameter unless otherwise specified. Boolean values are returned as 1 or 0, even when they can be set as `on` or `off`.

Note	When sending query commands immediately following an instrument setup command, a delay of up to two seconds may be required to allow the instrument sufficient time to complete the setup and receive the query.
-------------	--

Identifiers

The following identifiers have been used throughout the optional command definitions. Descriptions are provided here. In most cases, units are specified with the individual command.

Table 2-3. Description of Command Identifiers

Identifier	Description
<amplitude>	Amplitude value. Units specified with the command.
<freq>	Frequency. Units specified with the command.
<integer>	Integer value, no units. Range specified with the command.
<number>	Numeric value, integer, or real.
<percentage>	Percentage value from 0 to 00. Units are always %.
<rel ampl>	Relative amplitude. Units are always dB.
<x-parameter>	Parameter value in the units of the x-axis. Units are specified with the command.
<string>	The string should be enclosed in either single quotes (' ') or double quotes (" ").
<filename>	The name should be enclosed in either single quotes (' ') or double quotes (" "). The need for an extension is documented with applicable commands.
<voltage>	Voltage. Units specified with the command.
<current>	Current. Units specified with the command.

Data Parameters

Data parameters, referred to simply as “parameters,” are the quantitative values used as arguments for the command keywords. The parameter type associated with a particular SCPI command is determined by the type of information required to control the particular instrument function. For example, Boolean (ON | OFF) type parameters are used with commands that control switch functions.

Some command descriptions specify the type of data parameter to be used with each command. The most commonly used parameter types are numeric, extended numeric, discrete, and Boolean.

Numeric

Numeric parameters comprise integer numbers or any number in decimal or scientific notation, and may include polarity signs. This includes <NR1>, <NR2>, and <NR3> numeric data as defined in “[Data Parameter Notations](#)” below. Parameters that accept all three <NR> formats are designated <NRf> throughout this document.

Extended Numeric

Extended numeric parameters include values such as MAXimum and MINimum.

Discrete

Discrete parameters, such as INTernal and EXTernal, are used to control program settings to a predetermined finite value or condition.

Boolean

Boolean parameters represent binary conditions and may be expressed as ON, OFF or 1, 0.

Data Parameter Notations

The following syntax conventions are used for data parameter descriptions in this manual:

Table 2-4. Parameter Notations

<arg>	::=a generic command argument consisting of one or more of the other data types
<bNR1>	::=boolean values in <NR1> format; numeric 1 or 0
<boolean>	::=ON OFF. Can also be represented as 1 or 0, where 1 means ON and 0 means OFF Boolean parameters are always returned as 1 or 0 in <NR1> format by query commands
<integer>	::=an unsigned integer without a decimal point (implied radix point)
<NR1>	::=a signed integer without a decimal point (implied radix point)
<NR2>	::=a signed number with an explicit radix point
<NR3>	::=a scaled explicit decimal point numeric value with and exponent (e.g., floating point number)
<NRf>	::=<NR1> <NR2> <NR3>
<nv>	::=SCPI numeric value: <NRf> MINimum MAXimum UP DOWN DEFault NAN (Not A Number) INFINITY NINFINITY (Negative Infinity) or other types
<char>	::=<CHARACTER PROGRAM DATA> Examples: CW, FIXed, UP, and DOWN
<string>	::=<STRING PROGRAM DATA> ASCII characters enclosed by double quotes For example: "OFF"
<block>	::=IEEE-488.2 block data format
<NA>	::=Not Applicable

Unit Suffixes

Unit suffixes are not required for data parameters, provided the values are scaled for the global default units. The instrument SCPI default units are: Hz (Hertz) for frequency related parameters s (seconds) for time related parameters, and m (meters) for distance related parameters.

2-4 Notational Conventions

The SCPI interface standardizes command syntax and style that simplifies the task of programming across a wide range of instrumentation. As with any programming language, the exact command keywords and command syntax must be used. Unrecognized commands or improper syntax will not function.

Table 2-5. Notational Conventions

:	A colon links command keywords together to form commands. The colon is not an actual part of the keyword, but is a signal to the SCPI interface parser. A colon must precede a root keyword immediately following a semicolon (see “Notational Examples” on page 2-11).
;	A semicolon separates commands if multiple commands are placed on a single program line.
[]	Square brackets enclose one or more optional keywords.
{ }	Braces enclose one or more keyword or command parameters that may be included one or more times.
	A vertical bar indicates “or” and is used to separate alternative parameter options. Example: ON OFF is the same as ON or OFF.
< >	Angle brackets enclose parameter descriptions.
::=	Means “is defined as” For example: <a>::=<c> indicates that <c> can replace <a>.
sp	Space, referred to as <i>white space</i> , must be used to separate keywords from their associated data parameters. It must not be used between keywords or inside keywords.
XXX	Indicates a root command name

For further information about SCPI command syntax and style, refer to the Standard Commands for Programmable Instruments (SCPI) 1999.0 document.

2-5 Notational Examples

Table 2-6 provides examples of valid command syntax:

Table 2-6. Creating Valid Commands

Command Specification	Valid Forms
<code>[[:SENSE]:FREQUENCY:START <freq></code>	The following all produce the same result: <code>:SENSe:FREQUency:STARt 1 MHZ</code> <code>:SENS:FREQ:STAR 1 MHZ</code> <code>:sense:frequency:start 1000000</code> <code>:FREQ:STAR 1000 KHZ</code>
<code>:CALCulate:MARKer{1 2 3 4 5 6}:X <x-parameter></code>	The first 2 commands set the location of marker 1. The third command sets the location of marker 2. <code>:CALC:MARK:X 1 GHZ</code> <code>:CALC:MARK1:X 1 GHZ</code> <code>:CALC:MARK2:X 2 GHZ</code>
<code>:UNIT:POWer DBM DBV DBMV DBUV V W</code>	The following commands are identical: <code>:UNIT:POWer DBM</code> <code>:unit:pow dbm</code>
<code>:INITiate:CONTinuous OFF ON 0 1</code>	The following commands are identical: <code>:INITiate:CONTinuous OFF</code> <code>:init:cont 0</code>

Command statements read from left to right and from top to bottom. In the command statement above, the `:FREQUENCY` keyword immediately follows the `:SENSE` keyword with no separating space. A space (*sp*) is used between the command string and its argument.

Note that the first keyword in the command string does not require a leading colon; however, it is good practice to always use a leading colon for all keywords. Note also that the `:SENSE` keyword is optional. This is a SCPI convention for all voltage or signal source type instruments that allows shorter command statements to be used.

The following is an example of a multiple command statement that uses two separate commands in a single statement:

```
:FREQUENCY:START 10E6;:FREQUENCY:STOP 20E9
```

Note A semicolon is used to join the commands and a leading colon used immediately after the semicolon to start the second command.

Command Terminators

The <new line> character (ASCII 10) in the last data byte of a command string is used as a command terminator. Use of a command terminator will reset the command path to the root of the tree.

2-6 Formatting Conventions

This manual uses the following conventions in describing SCPI commands.

Table 2-7. Formatting Conventions

:COMMands:LOOK:LIKE:THIS	Commands are formatted to differentiate them from their description.
:COMMand:QUERies:LOOK:LIKE:THIS?	The query form of the command is followed by a “?”
Front-panel key sequences use this formatting	Front-panel key presses are formatted to differentiate them from text descriptions. Key presses are separated by a comma (“,”).
<identifier>	Identifiers are enclosed in “< >”. They indicate that some type of data must be provided. See Table 2-3 for details on the types of identifiers.
	The “ ” indicates that a choice must be made.
[optional input]	Optional input is be enclosed in “[]”. The “[]” are not part of the command.

2-7 Parameter Names

The following tables list the parameter options for the `:TRACe:PREamble?` command in each supported measurement mode.

Spectrum Analyzer Parameter Names

Table 2-8. Available Parameters in Spectrum Analyzer Mode (1 of 5)

Parameter Name	Description
SN	Instrument serial #
UNIT_NAME	Instrument name
DESCR	Trace name
DATE	Trace date/time
BASE_VER	Base FW version
APP_NAME	Application name
APP_VER	Application FW version
UNITS	Amplitude units
CENTER_FREQ	Center frequency
SPAN	Frequency span
FREQ_STEP	Frequency step size
FREQUENCY_OFFSET	Frequency Offset
OFFSET_STEP_SIZE	Offset Step Size
OFFSET_CENTER_FREQ	Center Frequency with Frequency Offset
OFFSET_START_FREQ	Start Frequency with Frequency Offset
OFFSET_STOP_FREQ	Stop Frequency with Frequency Offset
RBW	Resolution bandwidth
RBW_TYPE	RBW coupling auto/manual
VBW	Video bandwidth
VBW_TYPE	VBW coupling auto/manual
RBW_VBW_RATIO	RBW/VBW ratio
SPAN_RBW_RATIO	Span/RBW ratio
INPUT_ATTEN	Input attenuation
ATTEN_TYPE	Attenuation coupling auto/manual
REFERENCE_LEVEL	Reference level
SCALE	Y-axis scale
PREAMP_SET	Preamp state
REF_LEVEL_OFFSET	Reference level offset
DETECTION	Detection type
TRACE_AVERAGE	Number of traces to average

Table 2-8. Available Parameters in Spectrum Analyzer Mode (2 of 5)

Parameter Name	Description
SWEEP_TYPE	Single/continuous
CURRENT_SIGNAL	Current signal index
CURRENT_CHANNEL	Current signal channel
TRACE_MODE	Normal/Avg/Max
TRACE_STATUS	TRACE_A_VIEW_NOT_BLANK: 0x0000000000000001 TRACE_A_WRITE_NOT_HOLD: 0x0000000000000002 TRACE_A_DATA_VALID: 0x0000000000000004 TRACE_B_VIEW_NOT_BLANK: 0x0000000000010000 TRACE_B_WRITE_NOT_HOLD: 0x0000000000020000 TRACE_B_DATA_VALID: 0x0000000000040000 TRACE_C_VIEW_NOT_BLANK: 0x0000000100000000 TRACE_C_WRITE_NOT_HOLD: 0x0000000200000000 TRACE_C_DATA_VALID: 0x0000000400000000 TRACE_C_IS_B_MINUS_A_ON: 0x0000001000000000 TRACE_C_IS_A_MINUS_B_ON: 0x0000002000000000
TRACE_COUNT	Number of traces averaged
UI_DATA_POINTS	Number of display points
IMPEDANCE	Input impedance
REFERENCE_FREQUENCY	Reference freq
SET_SWEEP_TIME	Minimum sweep time setting
TRIGGER_TYPE	Trigger type
VIDEO_TRIGGER_LEVEL	Video trigger level
TRIGGER_POSITION	Trigger position as a percent of the display
PEAK_THRESHOLD	Marker peak search threshold
MARKER_TABLE	Marker table status
ACTIVE_MEASUREMENT	Current measurement
ANTENNA	Antenna index

Table 2-8. Available Parameters in Spectrum Analyzer Mode (3 of 5)

Parameter Name	Description
OCC_BW_METHOD	Occupied bandwidth method
OCC_BW_PERCENT	Occupied bandwidth % of power setting
OCC_BW_DBC	Occupied bandwidth dBc setting
OCC_BW_MEASURED_DB	Occupied bandwidth measured dBc value
OCC_BW_MEASURED_PERCENT	Occupied bandwidth measured % value
OCC_BW_VALUE	Measured occupied bandwidth
OCC_BW_LINE_MARKER_INFO	Mask off 16 bits at a time to get the display point location of the 3 OBW display indicators
CH_PWR_WIDTH	Channel power integration bandwidth
CH_PWR_VALUE	Measured channel power
CH_PWR_DENSITY	Measured channel power density
CH_PWR_LINE_MARKER_INFO	Mask off 16 bits at a time to get the display point location of the 2 channel power display indicators
ACPR_MAIN_CH_BW	ACPR main channel bandwidth
ACPR_ADJC_CH_BW	ACPR adjacent channel bandwidth
ACPR_CHANNEL_SPACING	ACPR channel spacing
ACPR_MAIN_CH_PWR	ACPR measured main channel power
ACPR_UPPER_CH_PWR	ACPR measured upper channel power
ACPR_LOWER_CH_PWR	ACPR measured lower channel power
ACPR_LOWER_CH_LINE_MARKER_INFO	Mask off 16 bits at a time to get the display point location of the 2 ACPR lower channel display indicators
ACPR_MAIN_CH_LINE_MARKER_INFO	Mask off 16 bits at a time to get the display point location of the 2 ACPR main channel display indicators
ACPR_UPPER_CH_LINE_MARKER_INFO	Mask off 16 bits at a time to get the display point location of the 2 ACPR upper channel display indicators
AM_FM_DEMOD_VOL	AM/FM demod volume
AM_FM_DEMOD_FREQUENCY	AM/FM demod freq
AM_FM_DEMOD_TYPE	AM/FM demod type
AM_FM_DEMOD_TIME	AM/FM demod time
AM_FM_LINE_MARKER	Display point location of the demodulation frequency
BEAT_FREQUENCY_OSC_FREQUENCY	BFO oscillator freq
CI_C_TYPE	C/I measurement carrier type
CI_C_VALUE	C/I measurement measured carrier power

Table 2-8. Available Parameters in Spectrum Analyzer Mode (4 of 5)

Parameter Name	Description
CI_I_BB_VALUE	C/I measurement measured broadband interference power
CI_I_NB_VALUE	C/I measurement measured narrowband interference power
CI_I_WB_VALUE	C/I measurement measured wideband interference power
CI_BB_VALUE	C/I measurement with broadband interference
CI_NB_VALUE	C/I measurement with narrowband interference
CI_WB_VALUE	C/I measurement with wideband interference
MKR_SPA_FREQNx	Marker x frequency (where x is the marker number 0–11, 0 represents the reference marker #1 and 1 represents delta marker #1, 2 represents reference marker #2, and 3 represents delta marker #2, and so on)
MKR_SPA_POINTx	Reference marker x display point
MKR_SPA_MAGNTx	Reference marker x magnitude
MKR_SPA_PRCNTx	Reference marker x display percentage
MKR_SPA_FLAGSx	Reference marker x flags: SPA_MKR_FLAG_ON_OFF: 0x00000001 SPA_MKR_FLAG_DELTA_MKR: 0x00000002 SPA_MKR_FLAG_SELECTED: 0x00000004 SPA_MKR_FLAG_DATA_INVALID: 0x00000008 SPA_MKR_FLAG_DATA_STALE: 0x00000010 SPA_MKR_FLAG_FIXED: 0x00000020 SPA_MKR_FLAG_MASK: 0x000000FF SPA_MKR_FLAG_DISPL_AMPL_HZ: 0x00000100 SPA_MKR_FLAG_DISPL_AMPL_PER_HZ: 0x00000200 SPA_MKR_FLAG_DISP_FLAG: 0x00000F00 SPA_MKR_FLAG_RELATIVE: 0x00001000 SPA_MKR_STANDARD: 0x10000000 SPA_MKR_FIELD_STRENGTH: 0x20000000 SPA_MKR_NOISE: 0x30000000 SPA_MKR_COUNTER: 0x40000000 SPA_MKR_TIME: 0x50000000

Table 2-8. Available Parameters in Spectrum Analyzer Mode (5 of 5)

Parameter Name	Description
MKR_SPA_REF_TOx	Specifies marker to which marker x is the reference
MKR_SPA_TRACEx	Specifies which trace receives marker x
LIM_LFLAGS_UP	Upper limit flags: LIMIT_FLAG_ON: 0x00000004 LIMIT_FLAG_ALARM_ON: 0x00000002
LIM_FREQNC_UPx	Upper limit point x freq (where x is the limit point number starting with 0)
LIM_MAGNTD_UPx	Upper limit point x amplitude
LIM_LFLAGS_LO	Lower limit flags: LIMIT_FLAG_ON: 0x00000004 LIMIT_FLAG_ALARM_ON: 0x00000002
LIM_FREQNC_LOx	Lower limit point x freq (where x is the limit point number starting with 0)
LIM_MAGNTD_LOx	Lower limit point x amplitude
EXTERNAL_ATTENUATION	Generator Matching Pads(3 dB)
EXTERNAL_GAIN_LOSS	Generator External Gain/Loss Setting
SG_FREQ	Generator CW Frequency
TG_GEN_SELECT	Generator CW/Tracking Mode Selection
TG_IL_ABS_AVG_PWR_VALUE	Generator Power Statistics (Average Value)
TG_IL_ABS_MAX_PWR_VALUE	Generator Power Statistics(Max Value)
TG_IL_ABS_MIN_PWR_VALUE	Generator Power Statistics (Min Value)
TG_LEVEL_1	Generator Output Power
TG_S21_NORMALIZE_ON_OFF	Generator Normalize Measurement

Cable & Antenna Parameter Names

Table 2-9. Available Parameters in Cable & Antenna Mode (1 of 4)

Parameter Name	Description
SN	Instrument serial #
UNIT_NAME	Instrument name
TYPE	The data type (Setup or Data).
DESCR	Trace name
DATE	Trace date/time
BASE_VER	Base FW version
APP_NAME	Application name
APP_VER	Application FW version
APP_MODE	Application Mode
CHECKSUM	Checksum
DIST_UNITS	Distance units
AMPL_UNITS	y-axis value units
MEASUREMENT	Measurement
1PORT_DOMAIN	1-Port Domain
FREQ_START	Start Frequency
FREQ_STOP	Stop Frequency
DIST_START	Start distance
DIST_STOP	Stop distance
CAL_STATUS	Calibrate Status (On/Off)
SWEEP_TIME	Sweep time
SWEEP_TYPE	Sweep type (Single/Continuous)
MARKER_SELECTED	The selected marker
MARKER_TABLE	Marker table status (On/Off)
TRACE_VIEW	Trace View (View/Blank)
TRACE_STATE	Trace State (Write/Hold)
WINDOWING	Windowing Type (Rectangular/Nominal Side Lobe/ Low Side Lobe/Minimum Side Lobe)
CABLE	Cable index from the cable list
PROP_VEL	Propagation velocity
CABLE_LOSS	Cable Loss
CW_STATUS	RF Immunity (On/Off)
OUTPUT_POWER_LEVEL	Power Level (High/Low)
CURRENT_SIGNAL_STD	Current signal standard
RESOLUTION	Sweep Resolution (137/275/551)

Table 2-9. Available Parameters in Cable & Antenna Mode (2 of 4)

Parameter Name	Description
SCALE	Y-axis scale
RF_SOURCE_POWER_LEVEL	Source Power Level
CAL_TEMP_WINDOW	Cal Temp window
CAL_COEFFICIENT_PTR	Calibrate coefficient
SMITH_CHART_TYPE	Smith chart type
DISPLAY_CHANNELS	Display Channels
ACTIVE_DISPLAY_CHANNEL	The current active display channel
NUM_OF_CHANNELS	Channel number
SEND_CAL_PROMPTS	Send Cal prompts
SET_SWEEP_DATA_TYPE	Set sweep data type
AVERAGING	Averaging
DISP_CHANNELS	Display channels
ACTIVE_DISP_CHANNEL	Active display channel
DMAX	Dmax
FAULT_RESOLUTION	Fault Resolution
SUGGESTED_SPAN	Suggested span
START_FREQ_STATUS	Start frequency status
AVERAGING_FACTOR	Averaging Factor.
AVERAGE_COUNT	Averaging count.
SCALE_RESOLUTION_RL_DIST	S_{11} Log Magnitude Fault Location scale resolution
SCALE_RESOLUTION_SWR	S_{11} VSWR scale resolution
SCALE_RESOLUTION_SWR_DIST	S_{11} VSWR Fault Location scale resolution
SCALE_RESOLUTION_CL	Cable loss Scale resolution
SCALE_RESOLUTION_IL	IL scale resolution
SCALE_RESOLUTION_IG	S_{21} Log Magnitude scale resolution
SCALE_RESOLUTION_PHASE_S11	S_{11} Phase scale resolution
REFERENCE_VALUE_PHASE_S11	S_{11} Phase reference value
REFERENCE_LINE_PHASE_S11	S_{11} Phase reference line
RL_DIST_BOTTOM	DTF Return Loss Bottom Value
SWR_DIST_TOP	DTF VSWR Top Value
SWR_DIST_BOTTOM	DTF VSWR Bottom Value
RL_MAG_TOP	Return Loss Top Value
RL_MAG_BOTTOM	Return Loss Bottom Value
SWR_MAG_TOP	VSWR Top Value
SWR_MAG_BOTTOM	VSWR Bottom Value

Table 2-9. Available Parameters in Cable & Antenna Mode (3 of 4)

Parameter Name	Description
CL_MAG_TOP	Cable Loss Top Value
CL_MAG_BOTTOM	Cable Loss Bottom Value
S11_PHASE_TOP	1-Port Phase Top Value
S11_PHASE_BOTTOM	1-Port Phase Bottom Value
MKR_REF_FREQNx	Reference marker x frequency (where x is the marker number 0–5)
MKR_REF_FLAGSx	Reference marker x flags: MKR_FLAG_ON_OFF: 0x00000001 MKR_FLAG_DELTA_MKR: 0x00000020 MKR_FLAG_DATA_INVALID: 0x00000040 MKR_FLAG_DATA_STALE: 0x00000080 MKR_FLAG_SELECTED: 0x00000100 MKR_FLAG_DELT_DISPL_PER_HZ: 0x00000800 MKR_FLAG_TRACE_A: 0x00001000 MKR_FLAG_TRACE_B: 0x00002000 MKR_FLAG_TRACE_MASK: 0x00007000
MKR_DLT_FREQNx	Delta marker x frequency (where x is the marker number 0–5)
MKR_DLT_FLAGSx	Delta marker x flags:
LIM_LFLAGS_UP-1	Upper limit flags: LIMIT_FLAG_UPPER: 0x00000001 LIMIT_FLAG_ON: 0x00000004 LIMIT_FLAG_ALARM_ON: 0x00000002 LIMIT_FLAG_SEGMENTED: 0x00000020 LIMIT_FLAG_ALARM_EVENT: 0x00000040 LIMIT_FLAG_LEFT_OF_START_FREQ: 0x00000080 LIMIT_FLAG_RIGHT_OF_STOP_FREQ: 0x00000100 LIMIT_FLAG_MASK: 0x000007FF
LIM_NUMPTS_UP-1	Number of upper limit points
LIM_CURFRQ_UP-1	Upper limit current frequency
LIM_CURMAG_UP-1	Upper limit current magnitude
LIM_PFLAGS_UPx	Upper limit x flags (where x is the limit point number starting with 0)
LIM_FREQNC_UPx	Upper limit point x freq (where x is the limit point number starting with 0)

Table 2-9. Available Parameters in Cable & Antenna Mode (4 of 4)

Parameter Name	Description
LIM_MAGNTD_UPx	Upper limit point x parameter (where x is the limit point number starting with 0)

GSM Parameter Names

Table 2-10. Available Parameters in GSM Mode

Parameter Name	Description
SN	Instrument serial #
UNIT_NAME	Instrument name
TYPE	The data type (Setup or Data)
DESCR	Trace name
DATE	Trace date/time
BASE_VER	Base FW version
APP_NAME	Application name
APP_VER	Application FW version
APP_MODE	Application Mode
REFERENCE_LEVEL	Reference Level
CENTER_FREQ	Center freq
SIGNAL_STANDARD	Current signal standard (the value is the index of the signal standard list, where a value of 1 is the first index in the list)
CHANNEL	Current channel
POWER_OFFSET	Applied power offset
REFERENCE_FREQUENCY	Selected external reference frequency
UNITS	Amplitude units
CURRENT_VIEW	Current view
CURRENT_MEASUREMENTS	Current measurements
DYNAMIC_ATTENUATION	Dynamic range on/off
SPAN	Frequency span
MANUAL_SYSTEM_SELECT	GSM/EDGE select
CURRENT_SPECTRUM_VIEW	Current spectrum view (single or multiple channel spectrum)
I_Q_VIEW	IQ view
RUN_HOLD	Run/Hold on/off
MC_SPECTRUM_START_FREQ	Multi-channel spectrum start frequency
MC_SPECTRUM_STOP_FREQ	Multi-channel spectrum stop frequency
MC_CHANNEL_CURSOR	Multi-channel spectrum channel cursor (used for markers)
MC_FREQ_CURSOR	Multi-channel spectrum frequency cursor (used for markers)
TEST_MODEL	Current pass fail model being tested

WiMAX, Mobile WiMAX Parameter Names**Table 2-11.** Available Parameters in WiMAX and Mobile WiMAX Mode (1 of 2)

Parameter Name	Description
SN	Instrument serial #
UNIT_NAME	Instrument name
TYPE	The data type (Setup or Data)
DESCR	Trace name
DATE	Trace date/time
BASE_VER	Base FW version
APP_NAME	Application name
APP_VER	Application FW version
APP_MODE	Application Mode
REFERENCE_LEVEL	Reference Level
UNITS	Amplitude units
SCALE	Y axis scale
CENTER_FREQ	Center freq
SIGNAL_STANDARD	Current signal standard (the value is the index of the signal standard list, where a value of 0 is the first index in the list)
CHANNEL	Current channel
POWER_OFFSET	Applied power offset
REFERENCE_FREQUENCY	Selected external reference frequency
UNITS	Amplitude units
CURRENT_VIEW	Current view
CURRENT_MEASUREMENTS	Current measurements
DYNAMIC_ATTENUATION	Dynamic range on/off
SPAN	Frequency span
PVT_FRAME_START_TIME	Power vs. Time start time
PVT_FRAME_STOP_TIME	Power vs. Time stop time
BW_SELECT	Current Bandwidth (MHz)
CURRENT_SPECTRUM_VIEW	Current spectrum view (single or multiple channel spectrum)
I_Q_VIEW	IQ view
RUN_HOLD	Run/Hold on/off
TEST_MODEL	Current pass fail model being tested
CP_RATIO	Cyclic Prefix Ratio (the value is the index of the CP Ratio list, where a value of 0 is the first index in the list)

Table 2-11. Available Parameters in WiMAX and Mobile WiMAX Mode (2 of 2)

Parameter Name	Description
SPECTRUM_SPAN	Spectrum frequency span (the value is the index of the span list, where a value of 0 is the first index in the list)
AUTO_SPAN	Auto span on/off
MAX_HOLD	Max hold on/off
EVM_SUB_CARRIER_TOP	Y-Axis Max for EVM vs. Symbol/Sub-Carrier
EVM_SUB_CARRIER_SCALE	EVM vs. Symbol/Sub-Carrier scale
SPECTRAL_FLATNESS_SCALE	Spectral Flatness scale
ACPR_DISPLAY_GRAPH	Display ACPR trace on/off
NUM_OF_ACPR_MAIN_CHANNELS	Number of main channels
NUM_OF_ACPR_ADJC_CHANNELS	Number of adjacent channels
CONSTELLATION_REFERENCE_POINTS	Constellation reference points on/off
SPECTRAL_FLATNESS_TOP	Y-Axis Max for Spectral Flatness
SPECTRAL_FLATNESS_EVM_SUB_START	Spectral Flatness/EVM vs. sub-carrier start
SPECTRAL_FLATNESS_EVM_SUB_STOP	Spectral Flatness/EVM vs. sub-carrier stop
EVM_SYM_START	EVM vs. Symbol start
EVM_SYM_STOP	EVM vs. Symbol stop

WCDMA Parameter Names

Table 2-12. Available Parameters in WCDMA Mode (1 of 2)

Parameter Name	Description
SN	Instrument serial #
UNIT_NAME	Instrument name
TYPE	The data type (Setup or Data)
DESCR	Trace name
DATE	Trace date/time
BASE_VER	Base FW version
APP_NAME	Application name
APP_VER	Application FW version
APP_MODE	Application Mode
CENTER_FREQ	Center frequency
AUTO_SCRAMBLING_CODE	Auto scrambling code detection on/off
SCRAMBLING_CODE	Selected manual scrambling code
MAX_SPREADING_FACTOR	Maximum spreading factor
REFERENCE_LEVEL	Reference Level
THRESHOLD	Active channel threshold
CURRENT_MEASUREMENTS	Currently active measurements
SCALE	Display scale (dB/division)
POWER_OFFSET	Applied power offset
SCCPCH_CODE	Selected S-CCPCH channelization code
PICH_CODE	Selected PICH channelization code
CURRENT_VIEW	Current view
CDP_ZOOM	Zoom range for code domain power
CDP_ZOOM_START	Start code for zoom window
REFERENCE_FREQUENCY	Reference Frequency
SCCPCH_SPREAD_FCT	Selected S-CCPCH spreading factor
RUN_HOLD	Run/hold state
EXT_REF_FREQ	Selected external reference frequency
DYNAMIC_ATTENUATION	Dynamic range on/off
ACLR_DISPLAY_GRAPH	Display ACLR trace on/off
MARKER_TABLE	Marker table on/off
OTA_AUTO_SC	OTA auto scrambling code on/off
OTA_CODE_LOCK	OTA code lock on/off
OTA_DISPLAY_VALUE	Selected OTA display value
OTA_SORT_PARAM	Selected OTA sort parameter

Table 2-12. Available Parameters in WCDMA Mode (2 of 2)

Parameter Name	Description
OTA_MANUAL_SC_1	Selected manual scrambling code 1
OTA_MANUAL_SC_2	Selected manual scrambling code 2
OTA_MANUAL_SC_3	Selected manual scrambling code 3
OTA_MANUAL_SC_4	Selected manual scrambling code 4
OTA_MANUAL_SC_5	Selected manual scrambling code 5
OTA_MANUAL_SC_6	Selected manual scrambling code 6
CODOGRAM_SINGLE_SWEEP_TIME	Single sweep time for codogram
TEST_MODEL	Current pass fail model being tested
CONSTELLATION_CODE	Code number for which IQ data is being displayed
CONSTELLATION_SPREAD	Spreading factor of code for which IQ data is being displayed
NUM_OF_ACLR_MAIN_CHANNELS	Number of main channels
NUM_OF_ACLR_MAIN_CHANNELS	Number of adjacent channels
BAND_SPECTRUM_START_FREQ	Band spectrum start frequency
BAND_SPECTRUM_STOP_FREQ	Band spectrum stop frequency
DL_CHANNEL_NUMBER	Currently selected band spectrum channel
AUTO_THRESHOLD	Auto threshold value
HSDPA_DEMOD_SINGLE_SWEEP_TIME	Single sweep time for hsdpa
BAND_SPECTRUM_REFERENCE_LEVEL	Reference level for band spectrum
CONSTELLATION_PERSISTENCE	Persistence level for IQ data
SIGNAL_STANDARD	Current Signal standard
CHANNEL	Current channel
CONSTELLATION_MARKER	Display location of the IQ marker
RF_MKR_POINT_[1] 2 3 4 5 6	RF marker point number
RF_MKR_STATE_[1] 2 3 4 5 6	RF marker on/off
DEMOD_MKR_POINT_[1] 2 3 4 5 6	Code domain marker point number
DEMOD_MKR_STATE_[1] 2 3 4 5 6	Code domain marker on/off
CODOGRAM_MKR_POINT_1	Codogram marker point number
CODOGRAM_MKR_STATE_1	Codogram marker on/off
CODOGRAM_MKR_TIME_1	Codogram marker time offset

CDMA Parameter Names

Table 2-13. Available Parameters in CDMA Mode (1 of 2)

Parameter Name	Description
UNIT_NAME	Instrument name
TYPE	The data type (Setup or Data)
DESCR	Trace name
DATE	Trace date/time
BASE_VER	Base FW version
APP_NAME	Application name
APP_VER	Application FW version
APP_MODE	Application Mode
CENTER_FREQ	Center frequency
REFERENCE_LEVEL	Reference Level
THRESHOLD	Active channel threshold
CURRENT_MEASUREMENTS	Currently active measurements
SCALE	Display scale (dB/division)
SPAN	Span
POWER_OFFSET	Applied power offset
CURRENT_VIEW	Current view
CDP_ZOOM	Zoom range for code domain power (16/32/64)
CDP_ZOOM_START	Start code for zoom window
REFERENCE_FREQUENCY	Reference Frequency
RUN_HOLD	Run/hold state
DYNAMIC_ATTENUATION	Dynamic range on/off
MARKER_TABLE	Marker table on/off
TEST_MODEL	Current pass fail model being tested
NUM_OF_ACLR_MAIN_CHANNELS	Number of main channels
NUM_OF_ACLR_ADJC_CHANNELS	Number of adjacent channels
SIGNAL_STANDARD	Current Signal standard
CHANNEL	Current channel
CHANNEL_WIDTH	Channel width
DATA_MODULATION	Data channel modulation type
PN_OFFSET	PN offset
WALSH_CODE	Walsh code (64/128)
CDP_SCALE	Code Domain Power scale
MEAS_SPEED	Measurement speed (Fast/Normal/Slow)
PN_TYPE	PN trigger type (No Trig/GPS/Ext)

Table 2-13. Available Parameters in CDMA Mode (2 of 2)

Parameter Name	Description
PN_SEARCH_TYPE	PN search type (Auto/Manual)
TRIGGER_POLARITY	Trigger polarity (Rising/Falling)
PN_INCREMENT	PN increment
SPUR_EMM_DISPLAY_POINTS	Number of Spurious Emission display points
CDP_UNITS	Code Domain Power unit type (Relative/Absolute)
USER_PWR_UNIT	Default unit (dBm/W/mW)
BAND_CLASS	Band class
USER_CARRIER_BW	Carrier bandwidth (1.23/1.24/1.25)
RF_MKR_POINT_[1] 2 3 4 5 6	RF marker point number
RF_MKR_STATE_[1] 2 3 4 5 6	RF marker on/off
DEMOD_MKR_POINT_[1] 2 3 4 5 6	Code domain marker point number
DEMOD_MKR_STATE_[1] 2 3 4 5 6	Code domain marker on/off

EVDO Parameter Names

Table 2-14. Available Parameters in EVDO Mode (1 of 2)

Parameter Name	Description
SN	Instrument serial #
UNIT_NAME	Instrument name
TYPE	The data type (Setup or Data)
DESCR	Trace name
DATE	Trace date/time
BASE_VER	Base FW version
APP_NAME	Application name
APP_VER	Application FW version
APP_MODE	Application Mode
CENTER_FREQ	Center frequency
REFERENCE_LEVEL	Reference Level
THRESHOLD	Active channel threshold
CURRENT_MEASUREMENTS	Currently active measurements
SCALE	Display scale (dB/division)
SPAN	Span
POWER_OFFSET	Applied power offset
CURRENT_VIEW	Current view
CDP_ZOOM	Zoom range for code domain power (16/32/64)
CDP_ZOOM_START	Start code for zoom window
REFERENCE_FREQUENCY	Reference Frequency
RUN_HOLD	Run/hold state
DYNAMIC_ATTENUATION	Dynamic range on/off
MARKER_TABLE	Marker table on/off
TEST_MODEL	Current pass fail model being tested
NUM_OF_ACLR_MAIN_CHANNELS	Number of main channels
NUM_OF_ACLR_ADJC_CHANNELS	Number of adjacent channels
SIGNAL_STANDARD	Current Signal standard
CHANNEL	Current channel
CHANNEL_WIDTH	Channel width
DATA_MODULATION	Data channel modulation type
PN_OFFSET	PN offset
WALSH_CODE	Walsh code (64/128)
POWER_TIME	Power vs. Time slot type
CDP_SCALE	Code Domain Power scale

Table 2-14. Available Parameters in EVDO Mode (2 of 2)

Parameter Name	Description
SPUR_EMM_DISPLAY_POINTS	Number of Spurious Emission display points
POWER_VS_TIME_THRESHOLD	Power vs. Time threshold
MEAS_SPEED	Measurement speed (Fast/Normal/Slow)
PN_TYPE	PN trigger type (No Trig/GPS/Ext)
PN_SEARCH_TYPE	PN search type (Auto/Manual)
TRIGGER_POLARITY	Trigger polarity (Rising/Falling)
PN_INCREMENT	PN increment
CDP_UNITS	Code Domain Power unit type (Relative/Absolute)
POWER_VS_TIME_START	Power vs. Time start chip
POWER_VS_TIME_STOP	Power vs. Time stop chip
USER_PWR_UNIT	Default unit (dBm/W/mW)
BAND_CLASS	Band class
USER_CARRIER_BW	Carrier bandwidth (1.23/1.24/1.25)
RF_MKR_POINT_[1] 2 3 4 5 6	RF marker point number
RF_MKR_STATE_[1] 2 3 4 5 6	RF marker on/off
DEMOD_MKR_POINT_[1] 2 3 4 5 6	Code domain marker point number
DEMOD_MKR_STATE_[1] 2 3 4 5 6	Code domain marker on/off

TDSCDMA Parameter Names

Table 2-15. Available Parameters in TDSCDMA Mode (1 of 2)

Parameter Name	Description
UNIT_NAME	Instrument name
TYPE	The data type (Setup or Data)
DESCR	Trace name
DATE	Trace date/time
BASE_VER	Base FW version
APP_NAME	Application name
APP_VER	Application FW version
APP_MODE	Application Mode
CENTER_FREQ	Center frequency
SIGNAL_STANDARD	Current Signal Standard
CHANNEL	Current Signal Standard Channel
SPAN	Span
REFERENCE_LEVEL	Reference Level
SCALE	Display Scale
POWER_OFFSET	Applied power offset
UNITS	0 = dBm, 1 = Watts
DYNAMIC_ATTENUATION	Dynamic range on/off
REFERENCE_FREQUENCY	Reference Frequency
OTA_DISPLAY_MODE	0 = Code Scan, 1 = Tau Scan
CURRENT_VIEW	Current view
CURRENT_MEASUREMENTS	Currently active measurements
POWER_TIME_VIEW	0 = Sub-Frame, 1 = Slot View
POWER_VS_TIME_START	Start time
POWER_VS_TIME_STOP	Stop time
SLOT_NUMBER_SET	Slot number (7 = auto)
SLOT_NUMBER_RETURN	Slot number
Dynamic Range	0 = Normal, 1 = Wide
MARKER_TABLE	Marker table on/off
NUM_OF_ACLR_MAIN_CHANNELS	Number of main channels
NUM_OF_ACLR_ADJC_CHANNELS	Number of adjacent channels
CHANNEL_WIDTH	Channel width
SCRAMBLING_CODE_SET	Scrambling code (128 = auto)
SCRAMBLING_CODE_SET_RETURN	Actual detected scrambling code
SCRAMBLING_CODE_1	Scrambling code 1

Table 2-15. Available Parameters in TDSCDMA Mode (2 of 2)

Parameter Name	Description
SCRAMBLING_CODE_2	Scrambling code 2
SCRAMBLING_CODE_3	Scrambling code 3
SCRAMBLING_CODE_4	Scrambling code 4
SPREADING_FACTOR	Spread factor
SYNC_DL_CODE_SET	Sync DL code (32 = auto)
SYNC_DL_CODE_RETURN	Actual detected sync DL code set
DWPTS	DWPTS Power
NUM_OF_CARRIERS	0 = 1 carrier, 1 = 3 carriers
MAX_USERS_SET	Max users set (0 = auto)
MAX_USERS_RETURN	Max users detected
UPLINK_SLOT_SWITCH_POINT	Uplink slot switch point set
THRESHOLD	Threshold
MEAS_SPEED	Measurement speed (Fast/Normal/Slow)
TAU_OFFSET	Tau time offset
TRIGGER_TYPE	Trigger type (No Trig/GPS/External)
TRIGGER_POLARITY	Trigger polarity (Rising/Falling)
TRIGGER_ACCURACY	Trigger accuracy
CDP_ZOOM	CDP Zoom
CDP_ZOOM_START	CDP Zoom Start
WALSH_CODE	Walsh Code
CDP_SCALE	CDP scale
CDP_UNITS	CDP units (Absolute/Relative)
DATA_MODULATION	Data Modulation (QPSK/8PSK/16QAM)
DEMOD_MODE	Demod mode
RUN_HOLD	Run/hold
CODE_AUTOSAVE	Code autosave on/off
TEST_MODEL	Current pass fail model being tested
RF_MKR_POINT_[1] 2 3 4 5 6	RF marker point number
RF_MKR_STATE_[1] 2 3 4 5 6	RF marker on/off
DEMOD_MKR_POINT_[1] 2 3 4 5 6	Code domain marker point number
DEMOD_MKR_STATE_[1] 2 3 4 5 6	Code domain marker on/off

Chapter 3 — All Mode Commands

3-1 :CONFigure Subsystem

This set of commands prepares the instrument for the selected measurement. It disables any currently-enabled measurements and activates the specified measurement. It sets the instrument to single sweep mode, waiting for an :INITiate command. It will not initiate the taking of a measurement.

Current instrument settings may be changed to default values. These changes are identified with their respective measurement commands.

Note

In dual display mode, the top and bottom channels CANNOT be the same measurement type.

:CONFigure:MEASure?

Title: Current Active Measurement Mode

Description: Reports the current active measurement mode.

Front Panel

Access: Measurements (Active measurement is indicated by the red radial button.)

:CONFigure:MEASure:1Phase

Title: Configure 1-Port Phase Measurement

Description: Changes the current measurement to 1-Port Phase.

Related

Command: :CONFigure:MEASure:?

Front Panel

Access: Shift-4 (Measure), More, 1-Port Phase

:CONFigure:MEASure:ACTiveChan 0|1

:CONFigure:MEASure:ACTiveChan?

Title: Active Channel 0/1

Description: Toggles between channel 0 (top) and 1 (bottom). Only functional in Dual Display Mode.

Front Panel

Access: Measurements (Active measurement is indicated by the red radial button.)

:CONFigure:MEASure:CABLoss

Title: Configure Cable Loss

Description: Changes the current measurement to Cable Loss.

Related

Command: :CONFigure:MEASure:?

Front Panel

Access: Shift-4 (Measure), Cable Loss

:CONFigure:MEASure:DUALdisplay DUAL|SINGLE**:CONFigure:MEASure:DUALdisplay?**

Title: Dual Display On/Off

Description: Turns dual display on or off.

Front Panel

Access: Measurements, Display Format

:CONFigure:MEASure:RLDTf

Title: Configure DTF Return Loss

Description: Changes the Cable & Antenna measurement to DTF Return Loss.

Related

Command: :CONFigure:MEASure:?

Front Panel

Access: Shift-4 (Measure), DTF Return Loss

:CONFigure:MEASure:RLFReq

Title: Configure Return Loss

Description: Changes the current measurement to Return Loss.

Related

Command: CONFigure:MEASure:?

Front Panel

Access: Shift-4 (Measure), Return Loss

:CONFigure:MEASure:SMCHart

Title: Configure Smith Chart

Description: Changes the current measurement to Smith Chart.

Related

Command: :CONFigure:MEASure:?

Front Panel

Access: Shift-4 (Measure), More, Smith Chart

:CONFigure:MEASure:SWRDtf

Title: Configure DTF VSWR

Description: Changes the current measurement to DTF VSWR.

Related

Command: :CONFigure:MEASure:?

Front Panel

Access: Shift-4 (Measure), DTF VSWR

:CONFigure:MEASure:SWRFreq

Title: Configure Standing Wave Ratio (SWR)

Description: Changes the current measurement to SWR.

Related

Command: :CONFigure:MEASure:?

Front Panel

Access: Shift-4 (Measure), SWR

3-2 :FETCh GPS Subsystem

Use this command to get GPS information.

:FETCh:GPS?

Title: Fetch GPS Information

Required Option: 31

Description: Returns the GPS fix status, UTC timing information, and the GPS location. The results are returned as a set of comma-delimited values in the following format:

```
<fix status>, <date/time>, <latitude>, <longitude>
```

The <fix status> field is either "GOOD FIX" or "NO FIX", depending whether the GPS receiver is currently calculating position data. If "NO FIX" is the value of the <fix status> field, then no data follows.

The date and time (<date/time> field) are returned in the following format:

```
Www Mmm dd hh:mm:ss yyyy
```

Where *Www* is the weekday in letters, *Mmm* is the month in letters, *dd* is the day of the month, *hh:mm:ss* is the time (24-hour time), and *yyyy* is the year.

Both <latitude> and <longitude> fields are expressed in radians. A negative latitude value corresponds to a “south” reading. A negative longitude value corresponds to a “west” reading.

Related Command: :SENSe:GPS

Front Panel

Access: Shift-8 (System), GPS, GPS Info

3-3 :INSTRUMENT Subsystem

One instrument may contain many logical instruments (“modes”). This subsystem controls the selection of the current instrument mode.

:INSTRUMENT:CATALOG:FULL?

Title: Query Available Modes

Description: Returns a comma-separated list of available modes. Mode names are enclosed in double quotes (“”). Immediately following the string name is the application number. For example, an instrument with SPA, WCDMA, Cable & Antenna, and Fixed WiMAX would return the string: “SPA”1,“WCDMA”5,“VNA”2,“WIMAX_D”18.

Front Panel

Access: Shift-9 (Mode) or Menu

Note The “VNA” return from the instrument refers to the Cable & Antenna measurement mode.

:INSTRUMENT:NSELECT <integer>

:INSTRUMENT:NSELECT?

Title: Select Mode by Number

Description: Sets the instrument mode based on the value of <integer>. The query version returns the number associated with the current mode. Use :INSTRUMENT:CATALOG:FULL? to get a list of available mode names and their integer representations. After issuing the set command, wait a minimum of 60 seconds before issuing the next command.

Parameter: <integer>

Parameter Type: <integer>

Related Command: :INSTRUMENT:CATALOG:FULL?
:INSTRUMENT[:SELECT]

Front Panel

Access: Shift-9 (Mode) or Menu

Note Switching modes can take longer than 80 seconds, depending on the application. Add a delay of at least 90 seconds between mode switch commands. Anritsu Company advises you to set the remote PC time-out to 120 seconds in order to avoid unexpected time-out errors.

:INSTRUMENT[:SELECT] <string>

:INSTRUMENT[:SELECT]?

Title: Select Mode by Name

Description: Sets the instrument mode based on the mode name specified by <string>. Enclose the <string> argument in single or double quotes. The query version returns the name of the current mode. Use :INSTRUMENT:CATALOG:FULL? to get a list of available modes.

Parameter: <string>

Related Command: :INSTRUMENT:CATALOG:FULL?
:INSTRUMENT:NSELECT

Front Panel

Access: Shift-9 (Mode) or Menu

Note

Switching modes can take longer than 80 seconds, depending on the application. Add a delay of at least 90 seconds between mode switch commands. Anritsu Company advises you to set the remote PC time-out to 120 seconds in order to avoid unexpected time-out errors.

3-4 :MMEMory Subsystem

The Mass Memory subsystem contains functions that provide access to the instrument's setup and data storage.

MMEM:DIR?

Title: Show Directory

Description: This command returns the non-recursive contents of the directory specified as the parameter. The parameter is case sensitive and must be enclosed in either single quotes (' ') or double quotes (" "). Use "/" as a directory separator. For the internal memory, the parameter must start with "Internal".

The response is formatted as follows:

```
<file entry><sp>\r\n<file entry>
```

Where <file entry> is either:

```
<file name><sp><file type><sp><timestamp><sp>
<file size>
```

Or <file entry> is:

```
<directory name><sp><file type><sp><timestamp>
<sp> should be a single space.
```

<timestamp> is the number of seconds since Jan 1 1970.

Parameter: <directory>

Parameter Type: <string>

Front Panel Access: Shift-7 (File)

:MMEMory:MSIS INTernal|USB

:MMEMory:MSIS?

Title: Save Location

Description: Sets the instrument's internal memory or the USB Flash drive as the save location for all subsequently saved files. This command also determines the destination location for copied files. For example, selecting internal memory as the current save location will set the USB Flash drive as the destination for copied files, and vice-versa.

Note that the save location specified here applies to remote operation. It is independent of and can be different from the save location set via the instrument front panel. The query form of this command returns the save location setting for remote operation, not the front panel setting.

Commands to load, store (save), or copy data will fail if the intended location is the USB drive and no USB device is plugged into the instrument.

Before setting the save location, send the `:SYSTEM:MSIS? USB` command to query the ready state of the USB Flash drive.

Parameter: INTernal|USB

Parameter Type: <char>

Related Command: `:MMEMemory:MSIS:DESTination`
`:SYSTEM:MSIS[:STATe]?`

Front Panel

Access: Shift-7 (File), Save, Change Save Location, (select drive or folder)

:MMEMemory:MSIS:COPY

Title: Copy from Current Save Location to Destination

Description: Copies all files and folders from the current save location to the destination. File hierarchy is maintained. When copying to USB, all data is placed in a folder named `usr` in the root directory of the drive. If the `usr` folder already exists, any file it contains that has the same name as a file being copied will be overwritten.

In remote operation, files can only be copied from internal memory to the USB device or from USB to internal memory. If you wish to copy to the same memory device or copy specific files and folders, use the instrument front panel.

The Copy command will not execute if no USB device is plugged in. Before copying files, send the `:SYSTEM:MSIS? USB` command to query the ready state of the USB Flash drive.

Note

Exercise caution before copying. Large files or a great number of files may take a long time to copy. The instrument will not respond to user input while files are being transferred.

Related Command: `:MMEMemory:MSIS`
`:MMEMemory:MSIS:DESTination`
`:SYSTEM:MSIS[:STATe]?`

Front Panel

Access: Shift-7 (File), Copy

:MMEMemory:MSIS:DESTination INTernal|USB

:MMEMemory:MSIS:DESTination?

Title: Destination of Copied Files

Description: Sets the destination location for files copied with the `:MMEMemory:MSIS:COPY` command. If USB is the destination, files and folders will be copied to a directory named `usr` at the root level of the USB device. If the `usr` folder currently exists, the `COPY` command will overwrite any file that has the same name as a copied file.

The Destination command also sets the current save location. For example, selecting the USB Flash drive as the destination will set the instrument's internal memory as the current save location, and vice-versa.

The destination location specified by SCPI command applies to remote operation. It is independent of and can be different from the destination selected using the instrument front panel. The query form of this command returns the destination location setting for remote operation, not the front panel setting.

This command is ineffective if the specified destination is not available, such as having no USB device plugged into the USB port. Before setting the destination location, send the :SYSTEM:MSIS? USB command to query the ready state of the USB drive.

Parameter: INTernal|USB

Parameter Type: <char>

Related Command: :MMEMory:MSIS
:MMEMory:MSIS:COPY
:SYSTEM:MSIS[:STATe]?

Front Panel

Access: Shift-7 (File), Copy, (select drive or folder under Select Destination)

:MMEMory:STORE:JPEG <filename>

Title: Save Screen as JPEG

Description: Saves the current screen measurement as a jpeg file. This will save the screen as a jpeg file specified by <filename> with the extension .jpg to the current save location. <filename> should be enclosed in either single quotes (') or double quotes (") and should not contain a file extension. Use the command MMEMory:MSIS to set the current save location.

Parameter: <filename>

Example: To save the screen into the file name "trace":

```
:MMEMory:STORE:JPEG "trace"
```

Related Command: :MMEMory:DATA?
:MMEMory:MSIS INTernal|USB

Front Panel

Access: Shift-7 (File), Save, Change Type, (select JPEG from list)

3-5 [[:SENSe] GPS Subsystem

This subsystem contains commands that relate to the optional GPS (Global Positioning System) on the instrument.

[[:SENSe]:GPS ON|OFF|1|0

[[:SENSe]:GPS?

Title: GPS State

Required Option: 31

Description: Toggles GPS ON or OFF.

The query form of this command returns a 0 or 1 when GPS state is OFF or ON, respectively.

Front Panel

Access: Shift-8 (System), GPS, GPS On/Off

[[:SENSe]:GPS:CURRent?

Title: GPS Antenna Current

Required Option: 31

Description: Query only. Reads the current draw, in mA, of the GPS antenna.

Front Panel

Access: Shift-8 (System), GPS, GPS Info

[[:SENSe]:GPS:RESet

Title: GPS Receiver Reset

Required Option: 31

Description: Resets the optional GPS receiver.

Front Panel

Access: Shift-8 (System), GPS, Reset

[[:SENSe]:GPS:VOLTage 0|1

[[:SENSe]:GPS:VOLTage?

Title: GPS Antenna Voltage

Required Option: 31

Description: Sets the GPS antenna voltage. Send the parameter value 0 to set the voltage to 3.3 V. To set the voltage to 5 V, send a 1 as the parameter value.

The query form of this command returns a 0 for an antenna voltage of 3.3 V and returns 1 for an antenna voltage of 5 V.

Front Panel

Access: Shift-8 (System), GPS, GPS Voltage

3-6 :STATus Subsystem

The commands in this subsystem relate to the current operating state of the instrument.

:STATus:OPERation?

Title: Query Operation Status

Description: This command requests information about the current status of the instrument. Each bit of the return value represents some operation. Only a subset of the bits are implemented for each application. The number returned is the decimal representation of the bit-wise OR of the enabled bits.

Note

Valid measurement modes that work with this command are SPA, GSM, WCDMA, TDSCDMA, CDMA, EVDO, Fixed WiMAX, and Mobile WiMAX.

Bit	Decimal Value	Description
	0	1 Not implemented
	1	2 Not implemented
	2	4 Not implemented
	3	8 Not implemented
	4	16 Not implemented
	5	32 Not implemented
	6	64 Not implemented
	7	128 Not implemented
	8	256 Sweep Complete

This bit is set to 0 when the command `:INITiate[:IMMEDIATE]` is sent to trigger a sweep. The bit will have a value of 1 when the sweep has completed.

	9	512 Not implemented
	10	1024 Not implemented
	11	2048 Not implemented
	12	4096 Not implemented
	13	8192 Not implemented
	14	16384 Not implemented
	15	0 Will always be 0

3-7 :SYSTem Subsystem

This subsystem contains commands that affect instrument functionality that does not directly relate to data collection, display or transfer.

:SYSTem:MSIS[:STATe]? INTernal|USB

Title: Query Memory State

Description: Queries the ready state of the instrument's internal memory or of the USB Flash drive. Use this command to check the ready state of the memory device before sending a command, such as :MMEMory:STORe or :MMEMory:MSIS:COPI, that requires the memory location to be available.

The USB query returns a 1 when a USB device is plugged into the USB port. It returns 0 if no USB drive is present.

Internal memory should always be available and the INT query should always return a 1.

Parameter: INTernal|USB

Parameter Type: <char>

Related Command: :MMEMory:MSIS
:MMEMory:MSIS:DESTination
:MMEMory:MSIS:COPI

:SYSTem:OPTions?

Title: Query Installed Options

Description: Returns a string of the installed options. Options are separated by a "/". The string will return "NONE" if no options are installed.

Related Command: *IDN?

:SYSTem:PRESet

Title: Preset

Description: This command restores all application parameters to their factory preset values. This does not modify system parameters such as language, volume or brightness.

Front Panel

Access: Shift-1 (Preset), Preset

Chapter 4 — Cable & Antenna Commands

4-1 :CALCulate Subsystem

The commands in this subsystem process data that has been collected via the SENSE subsystem.

:CALCulate:LIMit:ALARm OFF|ON|0|1

:CALCulate:LIMit:ALARm?

Title: Limit Alarm

Description: Enables/disables the currently active limit line alarm. Setting the value to ON or 1 will turn on the limit alarm. Setting the value to OFF or 0 will turn off the limit alarm. The query version of the command returns a 1 if the currently selected limit line alarm is set to ON and returns 0 if OFF.

Parameter: OFF|ON|0|1

Parameter Type: <boolean>

Default Value: OFF

Example: To turn off limit alarm:

```
:CALCulate:LIMit:ALARm OFF
:CALCulate:LIMit:ALARm 0
```

To turn on limit alarm:

```
:CALCulate:LIMit:ALARm ON
:CALCulate:LIMit:ALARm 1
```

Front Panel

Access: Shift-6 (Limit), Limit Alarm

:CALCulate:LIMit:CLEAr

Title: Clear Selected Limit

Description: Deletes all limit points for the currently active limit line.

Front Panel

Access: Shift-6 (Limit), Clear Limit

:CALCulate:LIMit:POINT:ADD

Title: Add Limit Point

Description: Adds a new limit point to the currently active limit line.

Front Panel

Access: Shift-6 (Limit), Multi-Segment Edit, Add Point

:CALCulate:LIMit:POINT:FREQuency <freq>

:CALCulate:LIMit:POINT:FREQuency?

Title: Limit Point Frequency

Description: Sets the limit point frequency of the current selected limit.

Parameter: <freq>

Default Unit: Hz

Front Panel

Access: Shift-6 (Limit), Multi-Segment Edit, Point Freq

:CALCulate:LIMit:POINT:VALue <value>

:CALCulate:LIMit:POINT:VALue?

Title: Limit Point Value

Description: Sets the limit point value of the current selected limit. The <value> parameter is the limit point value in dB or time units for group delay.

Parameter: <value>

Default Unit: Current active value unit.

Front Panel

Access: Shift-6 (Limit), Multi-Segment Edit, Point Value

:CALCulate:LIMit:POINT?

Title: Number of Limit Points

Description: Returns the number of points currently in the selected limit line.

:CALCulate:LIMit[:STATE] OFF|ON|0|1

:CALCulate:LIMit[:STATE]?

Title: Limit State

Description: Turns the limit line ON or OFF. If the value is set to ON or 1, the currently selected limit line is ON. If the value is set to OFF or 0, the currently selected limit line is OFF. The query version of the command returns a 1 if the currently selected limit line is ON and returns a 0 if OFF.

Parameter: OFF|ON|0|1

Parameter Type: <boolean>

Default Value: OFF

Example: To turn on the limit line:

```
:CALCulate:LIMit ON
:CALCulate:LIMit:STATE ON
:CALCulate:LIMit:STATE 1
```

To turn off the limit line:

```
:CALCulate:LIMit OFF
:CALCulate:LIMit:STATE 0
:CALCulate:LIMit 0
```

Front Panel

Access: Shift-6 (Limit), Limit On/Off

:CALCulate:MARKer:AOff

Title: Turn All Markers Off

Description: Turns off all markers.

Front Panel

Access: Marker, All Markers Off

:CALCulate:MARKer:TABLE:DATA?

Title: Marker Table Data

Description: Reports marker information similar to the Marker table. The response begins with an ASCII header. The header specifies the number of following bytes. It looks like #AX, where A is the number of digits in X and X is the number of bytes that follow the header. Parameters are returned in comma-delimited ASCII format. Each parameter is returned as "NAME=VALUE[UNITS]."

Parameter Name	Description
MKR_REFx	Reference marker state
MKR_DLTx	Delta marker state.
MKR_REF_FREQNx	Reference marker x frequency
MKR_DLT_FREQNx	Delta marker x frequency
MKR_REF_AMPLy	Reference marker y-axis
MKR_DLT_AMPL	Delta marker y magnitude.

x = marker 1 to 6.

Front Panel

Access: Marker, Marker Table On

:CALCulate:MARKer:TABLE[:STATE] OFF|ON**:CALCulate:MARKer:TABLE[:STATE]?**

Title: Marker Table State

Description: Turns the Marker Table on or off. Setting the value to ON will turn on the marker table. Setting the value to OFF will turn off the marker table.

Parameter: OFF|ON

Parameter Type: <boolean>

Default Value: OFF

Example: To turn on marker table:

```
:CALCulate:MARKer:TABLE ON
```

Front Panel

Access: Marker, Marker Table

:CALCulate:MARKer{1|2|3|4|5|6}:DELta:X <x-parameter>
:CALCulate:MARKer{1|2|3|4|5|6}:DELta:X?

Title: Delta Marker X Value

Description: Sets the location of the delta marker on the x-axis at the specified location <x-parameter> + the reference marker x-axis. <x-parameter> is defined in the current x-axis units. The query version of the command returns the location of the delta marker on the x-axis.

Parameter: <x-parameter>

Default Unit: Current x-axis unit

Example: If both the reference and delta marker #1 is currently at 1 GHz on the x-axis, send the command below to set the delta marker #1 to 2 GHz on the x-axis:

```
:CALCulate:MARKer1:DELta:X 1GHz
```

Related Command: :CALCulate:MARKer[1|2|3|4|5|6]:X

Front Panel

Access: Marker, Delta

:CALCulate:MARKer{1|2|3|4|5|6}:DELta:Y?

Title: Delta Marker Read Y Value

Description: Reads the current absolute Y value for the specified delta marker. The units are the units of the y-axis.

Default Unit: Current y-axis unit

:CALCulate:MARKer{1|2|3|4|5|6}:DELta[:STATE] OFF|ON|0|1
:CALCulate:MARKer{1|2|3|4|5|6}:DELta[:STATE]?

Title: Delta Marker State

Description: Sets the specified delta marker on or off.

Parameter: OFF|ON|0|1

Parameter Type: <boolean>

Default Value: OFF

Example: To turn on delta marker #3:

```
:CALCulate:MARKer3:DELta ON
:CALCulate:MARKer3:DELta 1
:CALCulate:MARKer3:DELta:STATE ON
:CALCulate:MARKer3:DELta:STATE 1
```

To turn off delta marker #6

```
:CALCulate:MARKer6:DELta OFF
:CALCulate:MARKer6:DELta:STATE OFF
:CALCulate:MARKer6:DELta:STATE 0
```

Front Panel

Access: Marker, Delta

:CALCulate:MARKer{1|2|3|4|5|6}:PEAK

Title: Marker Peak Search

Description: Puts the specified marker at the maximum value in the trace.

Related Command: :CALCulate:MARKer[1|2|3|4|5|6]:MAXimum

Front Panel

Access: Marker, Marker [1/2/3/4/5/6], Marker to Peak

:CALCulate:MARKer{1|2|3|4|5|6}:VALley

Title: Marker Valley Search

Description: Puts the specified marker at the minimum value in the trace.

Related Command: :CALCulate:MARKer[1|2|3|4|5|6]:MINimum

Front Panel

Access: Marker, Marker [1/2/3/4/5/6], Marker to Valley

:CALCulate:MARKer{1|2|3|4|5|6}:X <x-parameter>**:CALCulate:MARKer{1|2|3|4|5|6}:X?**

Title: Marker X Value

Description: Sets the location of the marker on the x-axis at the specified location. <x-parameter> is defined in the current x-axis units. The query version of the command returns the location of the marker on the x-axis. Note that the marker is snapped to the data point closest to the specified value. If the specified marker is not on, it is set to on.

Parameter: <x-parameter>

Default Unit: Current x-axis unit

Example: To set reference marker #2 to 1GHz on the x-axis:

```
:CALCulate:MARKer2:X 1GHz
```

To set reference marker #1 to 1.5 GHz on the x-axis:

```
:CALCulate:MARKer:X 1.5GHz
```

```
:CALCulate:MARKer1:X 1.5GHz
```

Front Panel

Access: Marker, Marker [1/2/3/4/5/6]

:CALCulate:MARKer{1|2|3|4|5|6}:Y?

Title: Marker Read Y Value

Description: Reads the current Y value for the specified marker. The units are the units of the y-axis.

Default Unit: Current y-axis unit

:CALCulate:MARKer{1|2|3|4|5|6}[:STATe] OFF|ON|0|1

:CALCulate:MARKer{1|2|3|4|5|6}[:STATe]?

Title: Marker State

Description: Sets the specified marker on/off. If no marker is specified in {1|2|3|4|5|6}, then marker defaults to 1.

Parameter: OFF|ON|0|1

Parameter Type: <boolean>

Default Value: OFF

Example: To turn off reference marker #1:

```
:CALCulate:MARKer1:STATe OFF
```

Front Panel

Access: Marker, On/Off

:CALCulate:MATH:FUNCTION NORMAl|ADD|SUBTract

:CALCulate:MATH:FUNCTION?

Title: Trace Math Function

Description: Sets math operations on the currently selected measurement and the trace stored in memory. Note that there MUST be a trace stored in Memory. Setting the FUNCTION to NORMAl is equivalent of setting the Trace Math to “No Trace Math” on the front panel. Setting the FUNCTION to ADD is equivalent of setting the Trace Math to “Trace Plus Memory” on the front panel. Setting the FUNCTION to SUBTract is equivalent to setting the Trace Math to “Trace Minus Memory” on the front panel. The query version of the command returns the string “NORM” for no trace math, returns the string “ADD” for trace plus memory, and returns the string “SUBT” for trace minus memory.

Parameter: NORMAl|ADD|SUBTract

Parameter Type: <char>

Default Value: NORMAl

Range: NORMAl|ADD|SUBTract

Related Command: :CALCulate:MATH:MEMorize

Front Panel

Access: Shift-5 (Trace)

:CALCulate:MATH:MEMorize

Title: Trace To Memory

Description: Copies the current measurement trace into memory.

Front Panel

Access: Shift-5 (Trace), Copy Trace To Display Memory

:CALCulate:MATH:OVERlay ON|OFF

Title: Trace Overlay On/Off

Description: Turns trace stored in memory on or off.

Front Panel

Access: Shift-5 (Trace), Trace Overlay

:CALCulate:SMOothing <integer>**:CALCulate:SMOothing?**

Title: Smoothing

Description: Sets the smoothing percentage. The query form of the command returns the current smoothing percentage.

Parameter: <integer>

Parameter Type: <integer>

Default Value: 0

Default Unit: %

Range: 0 to 10

Front Panel

Access: Shift-3 (Sweep), Averaging Smoothing, Smoothing %

:CALCulate:TRANSform:CLAverage?

Title: Cable Loss Average

Description: Reports the cable loss average.

Default Value: 0 dB

Default Unit: dB

:CALCulate:TRANSform:DISTance:CABLoss**:CALCulate:TRANSform:DISTance:CABLoss?**

Title: Cable Loss

Description: Sets the cable loss for DTF measurements.

Default Value: 0

Range: 0.0 to 5

Front Panel

Access: Measurements, Cable Loss

:CALCulate:TRANSform:DISTance:DMAX?

Title: Distance Maximum

Description: Reports the maximum horizontal distance that can be analyzed in DTF. Note that the unit return is based on the current distance units.

Default Value: Dependent on instrument model number and frequency range.

Default Unit: Meters (m)

Range: 0.0 m to 1500 m

:CALCulate:TRANSform:DISTance:FRESolution?

Title: Fault Resolution

Description: Reports the system's ability to separate two closely spaced discontinuities in DTF measurements. Note that the return value is based on the current distance units.

Default Value: Dependent on instrument model number and frequency range.

Default Unit: Meters (m)

Range: 0.0 m to 1500 m

:CALCulate:TRANSform:DISTance:PVELocity**:CALCulate:TRANSform:DISTance:PVELocity?**

Title: Propagation Velocity

Description: Sets the propagation velocity of the cable for DTF measurements.

Default Value: 0.8

Range: 0.001 to 1.0

Front Panel

Access: Freq/Dist, More, Prop Velocity (Note: For DTF measurements only.)

:CALCulate:TRANSform:DISTance:START**:CALCulate:TRANSform:DISTance:START?**

Title: Start Distance

Description: Sets the start distance for DTF measurements.

Default Value: 0.0 m

Default Unit: Meters (m)

Range: 0.0 m to 1000.0 m

Front Panel

Access: Freq/Dist, Start Dist

:CALCulate:TRANSform:DISTance:STOP
:CALCulate:TRANSform:DISTance:STOP?

Title: Stop Distance

Description: Sets the stop distance for DTF measurements.

Default Value: 5.48 m

Default Unit: Meters (m)

Range: 0.0 m to 1000.0 m

Front Panel

Access: Freq/Dist, Stop Dist

:CALCulate:TRANSform:DISTance:UNIT METers|FEET
:CALCulate:TRANSform:DISTance:UNIT?

Title: Distance Units

Description: Sets the units to be used for DTF measurements.

Parameter: METers|FEET

Parameter Type: <char>

Default Value: Meters

Range: METers|FEET

Front Panel

Access: Freq/Dist, Units

:CALCulate:TRANSform:DISTance:WINDow
RECTangular|MSLobe|NSLobe|LSLobe
:CALCulate:TRANSform:DISTance:WINDow?

Title: Windowing

Description: Sets the windowing for DTF measurements. Available types are Rectangular, Nominal Side Lobe, Low Side Lobe and Minimum Side Lobe.

Parameter: RECTangular|MSLobe|NSLobe|LSLobe

Parameter Type: <char>

Default Value: Rectangular

Range: RECTangular|MSLobe|NSLobe|LSLobe

Front Panel

Access: Freq/Dist, More, Window

4-2 :CALibration Subsystem

This subsystem controls the system calibration.

:CALibration:STATE?

Title: Calibration State

Description: Reports the calibrated state. This command returns a 1 if the instrument has been calibrated with discrete Open, Short, and Load components and returns 0 if the instrument has not been calibrated.

Related Command: [:SENSe]CORRection:COLL:LOAD
[:SENSe]CORRection:COLL:OPEN
[:SENSe]CORRection:COLL:SHORT

4-3 :CONFigure Subsystem

This set of commands prepares the instrument for the selected measurement. It disables any currently-enabled measurements and activates the specified measurement. It sets the instrument to single sweep mode, waiting for an :INITiate command. It will not initiate the taking of a measurement.

Current instrument settings may be changed to default values. These changes are identified with their respective measurement commands.

Note In dual display mode, the top and bottom channels CANNOT be the same measurement type.

:CONFigure:MEASure?

Title: Current Active Measurement Mode

Description: Reports the current active measurement mode.

Front Panel

Access: Measurements (Active measurement is indicated by the red radial button.)

:CONFigure:MEASure:1Phase

Title: Configure 1-Port Phase Measurement

Description: Changes the current measurement to 1-Port Phase.

Related

Command: :CONFigure:MEASure:?

Front Panel

Access: Shift-4 (Measure), More, 1-Port Phase

:CONFigure:MEASure:ACTiveChan 0|1

:CONFigure:MEASure:ACTiveChan?

Title: Active Channel 0/1

Description: Toggles between channel 0 (top) and 1 (bottom). Only functional in Dual Display Mode.

Front Panel

Access: Measurements (Active measurement is indicated by the red radial button.)

:CONFigure:MEASure:CABLoss

Title: Configure Cable Loss

Description: Changes the current measurement to Cable Loss.

Related

Command: :CONFigure:MEASure:?

Front Panel

Access: Shift-4 (Measure), Cable Loss

:CONFigure:MEASure:DUALdisplay DUAL|SINGLE**:CONFigure:MEASure:DUALdisplay?**

Title: Dual Display On/Off

Description: Turns dual display on or off.

Front Panel

Access: Measurements, Display Format

:CONFigure:MEASure:RLDTf

Title: Configure DTF Return Loss

Description: Changes the Cable & Antenna measurement to DTF Return Loss.

Related

Command: :CONFigure:MEASure:?

Front Panel

Access: Shift-4 (Measure), DTF Return Loss

:CONFigure:MEASure:RLFReq

Title: Configure Return Loss

Description: Changes the current measurement to Return Loss.

Related

Command: CONFigure:MEASure:?

Front Panel

Access: Shift-4 (Measure), Return Loss

:CONFigure:MEASure:SMCHart

Title: Configure Smith Chart

Description: Changes the current measurement to Smith Chart.

Related

Command: :CONFigure:MEASure:?

Front Panel

Access: Shift-4 (Measure), More, Smith Chart

:CONFigure:MEASure:SWRDtf

Title: Configure DTF VSWR

Description: Changes the current measurement to DTF VSWR.

Related

Command: :CONFigure:MEASure:?

Front Panel

Access: Shift-4 (Measure), DTF VSWR

:CONFigure:MEASure:SWRFreq

Title: Configure Standing Wave Ratio (SWR)

Description: Changes the current measurement to SWR.

Related

Command: :CONFigure:MEASure:?

Front Panel

Access: Shift-4 (Measure), SWR

4-4 :DISPlay Subsystem

This subsystem provides commands that modify the display of data for the user. They do not modify the way in which data are returned to the controller.

:DISPlay:WINDow:TRACe:Y[:SCALE]:AUToscale

Title: Autoscale

Description: Autoscales the active channel display so that the trace is shown in the middle of the display.

Front Panel

Access: Amplitude, Autoscale

:DISPlay:WINDow:TRACe:Y[:SCALE]:BOTTom <value>

Title: Scale Bottom level.

Description: Sets the Bottom value for the current graph. This command is invalid for Smith charts.

Default Unit: Current active amplitude unit

Range: Log Magnitude: 0 dB to 60 dB

Phase: -180 degree to 90 degree

VSWR: 1 to 65

DTF RL: 0 dB to 60 dB

DTF VSWR: 1 to 65

S21 Log Magnitude: 0.1 dB to 25 dB

S21 Phase: 0.1 degree to 90 degree

Front Panel

Access: Amplitude, Bottom

:DISPlay:WINDow:TRACe:Y[:SCALE]:TOP <value>

Title: Scale Top level.

Description: Sets the Top value for the current graph. This command is invalid for Smith charts.

Default Unit: Current active amplitude unit

Range: Log Magnitude: 0 dB to 60 dB

Phase: -180 degree to 90 degree

VSWR: 1 to 65

DTF RL: 0 dB to 60 dB

DTF VSWR: 1 to 65

S21 Log Magnitude: 0.1 dB to 25 dB

S21 Phase: 0.1 degree to 90 degree

Front Panel

Access: Amplitude, Top

```
:DISPlay:WINDow:TRACe:Y[:SCALE]:SMCHart 0|10|20|30|-3
:DISPlay:WINDow:TRACe:Y[:SCALE]:SMCHart?
```

Title: Smith Chart Scalable Type

Description: Sets the Smith chart display scale type. Setting the value to 0 is equivalent of setting the Smith Chart scale to “Normal” on the front panel. Setting the value to 10 is equivalent of setting the Smith Chart scale to “Expand 10dB” on the front panel. Setting the value to 20 is equivalent of setting the Smith Chart scale to “Expand 20dB” on the front panel. Setting the value to 30 is equivalent of setting the Smith Chart scale to “Expand 30dB” on the front panel. Setting the value to -3 is equivalent of setting the Smith Chart scale to “Compress 3dB” on the front panel.

Parameter: 0|10|20|30|-3

Default Value: Normal

Default Unit: Current active amplitude unit

Range: 0|10|20|30|-3

Front Panel

Access: Amplitude (In Smith Chart measurement view.)

4-5 :FORMat Subsystem

This subsystem contains commands that determine the formatting of numeric data when it is transferred.

The format setting affects data in specific commands only. If a command is affected, then it is noted in the command description.

:FORMat[:READings][:DATA] ASCii|INTeger,32|REAL,32
:FORMat[:READings][:DATA]?

Title: Numeric Data Format

Description: This command specifies the format in which data is returned in certain commands.

ASCii format returns the data in comma-separated ASCII format. The units are the current instrument units. This format requires many more bytes so it is the slowest format. INTeger 32 values are signed 32-bit integers in little-endian byte order. This format returns the data in 4-byte blocks.

The units are always mdBm. For example, if the measured result were -12.345 dBm, that value would be sent as -12345.) REAL,32 values are 32-bit floating point numbers conforming to the IEEE 754 standard in little-endian byte order. This format returns the data in 4-byte binary format. The units are the current instrument units.

Both INTeger,32 and REAL,32 formats return a definite block length. Each transfer begins with an ASCII header such as #42204. The first digit represents the number of following digits in the header (in this example, 4). The remainder of the header indicates the number of bytes that follow the header (in this example, 2204). You then divide the number of following bytes by the number of bytes in the data format you've chosen (4 for both INTeger,32 and REAL,32) to get the number of data points (in this example, 551).

Parameter: ASCii|INTeger,32|REAL,32

Parameter Type: <char>

Default Value: ASCii

Related Command: :TRACe[:DATA]

Interpreting Returned Data Pair

The following section provides two conversion examples on interpreting returned data pairs. Examples are provided for both integer and real number formats.

Converting INTeger,32 and REAL,32 Values

- For a 551 point trace, the instrument returns 4415 bytes.
 - The first 7 bytes make up the “header” information in ASCII format.
 - The next 4408 bytes make up the actual data (8 bytes x 551 datapoints = 4408 total bytes).
- Each datapoint consists of 8 bytes.
 - The first 4 bytes are the real component
 - The next 4 bytes are the imaginary component.
- The returned value is in little endian format (the little end comes first).
- Negative numbers are represented in two’s compliment format.
- The data is scaled by a factor of 1e6.

Converting INTeger,32 Example:

The instrument returns the following S11 RL data point in INT,32 format:

```
4d 15 fc ff [real], ef a2 f8 ff [imag]
```

1. Convert from little endian to big endian:

```
ff fc 15 4d [real], ff f8 a2 ef [imag]
```

2. Since the MSb in both components is 1, they are negative numbers.

3. The binary representation is:

```
1111111111111111000001010101001101 [real],  
11111111111111110001010001011101111 [imag]
```

4. Only perform this step on negative numbers noted in [Step 2](#). Negate the two's complement negative number to a positive number (complement the bits and add 1):

```
111110101010110011 [real], 1110101110100010001 [imag]
```

5. Convert to decimal:

```
256691 [real], 482577 [imag]
```

6. If a number was negated in [Step 4](#), it should be negated again:

```
-256691 [real], -482577 [imag]
```

7. Take out the 1e6 scale factor:

```
-0.256691 [real], -0.482577 [imag]
```

8. Finally, convert the values to dB:

```
10*log(-0.256691^2 + -0.482577^2) = -5.25 dB
```

Converting REAL,32 Example:

The instrument returns the following values in REAL,32 format:

00 31 2a 47 [real], 00 e8 6a c6 [imag]

1. Convert from little endian to big endian:

47 2a 31 00 [real], c6 6a e8 00 [imag]

2. The binary representation of the real portion, 47 2a 31 00 is:

01000111 00101010 01110001 00000000

3. Binary is in IEEE format:

- 1st bit is sign bit
- next 8 bits are exponent
- next 23 bits are normalized value

4. Convert binary to decimal:

0, the MSb is the sign bit

10001110, exponent. The actual exponent value is this value minus 127. So, it is $142 - 127 = 15$.

0101010 01110001 00000000 (as normalized value) and adding 1 and multiplying by 2^{exponent} results in $1 + (0/2 + 1/4 + 0/8 + 1/16 + 0/32 + 1/64 + \dots) * 2^{15} = 43520$ (approx.)

5. Repeat [Step 2](#) through [Step 4](#) for the imaginary portion.

c6 6a e8 00 in binary is 11000110 01101010 11101000 00000000

The MSb is the sign bit

The next 8 bits are the exponent, which is 10001100. The actual value is $140 - 127 = 13$

Converting the remaining bits and multiplying by exponent and accounting for sign, results in $-(1 + (1/2 + 1/4 + 0/8 + 1/16 + 0/32 + 1/64 + \dots) * 2^{13}) = -14976$ (approx).

6. Take out the 1e6 scale factor from both parts:

.043520 [real], -.014976 [imag]

7. Finally, convert the values to dB:

$10 * \log((.043520)^2 + (-.014976)^2) = -26.7401848 \text{ dB}$

4-6 :INITiate Subsystem

This subsystem controls the triggering of measurements.

:INITiate:CONTInuous OFF|ON|0|1

:INITiate:CONTInuous?

Title: Continuous/Single Sweep

Description: Specifies whether the sweep/measurement is triggered continuously. If the value is set to ON or 1, another sweep/measurement is triggered as soon as the current one completes. If continuous is set to OFF or 0, the instrument enters the “idle” state and waits for the :INITiate[:IMMediate] command or for :INITiate:CONTInuous ON. The default value is ON. That is, sending :INIT:CONT is equivalent to sending :INIT:CONT ON. The query version of the command returns a 1 if the instrument is continuously sweeping/measuring and returns a 0 if the instrument is in single sweep/measurement mode. Note that rapid toggling between ON and OFF is not allowed. The instrument must be allowed to make a full sweep before toggling can be done. Note that the set command is available only if the instrument is in Cable & Antenna mode.

Parameter: OFF|ON|0|1

Parameter Type: <boolean>

Default Value: 0

Related Command: :INITiate[:IMMediate]
:INITiate:HOLD

Front Panel

Access: Shift-3 (Sweep), Sweep Type

:INITiate:HOLD OFF|ON|0|1

:INITiate:HOLD?

Title: Hold Sweep

Description: Stops a sweep at its current measurement point. If the instrument is currently sweeping, setting a value of ON or 1, will pause the sweep. If the instrument is currently not sweeping, setting a value of OFF or 0, will resume sweeping. The query version of the command returns a 1 if the hold command is set and returns a 0 if a Run is set instead. Note that the set command is available only if the instrument is in Cable & Antenna mode.

Parameter: OFF|ON|0|1

Parameter Type: <boolean>

Default Value: 0

Front Panel

Access: Shift-3 (Sweep), Run/Hold

:INITiate [:IMMediate]

Title: Trigger Sweep/Measurement

Description: Initiates a sweep/measurement. If :INITiate:CONTinuous is set to ON, this command is ignored. Use this command in combination with :STATus:OPERation? to synchronize the capture of one complete set of data. When this command is sent, the “sweep complete” bit of :STATus:OPERation? is set to 0, indicating that the measurement has not completed. The data collection is then triggered. The controlling program can poll :STATus:OPERation? to determine the status. When the “sweep complete” bit is set to 1, data is ready to be retrieved.

Related Command: :INITiate:CONTinuous
:STATus:OPERation?

Front Panel

Access: Shift-3 (Sweep), Run/Hold, Run

(Note: When the unit is in “Hold Mode”, sending this command will initiate a sweep from the point at which is left off.)

4-7 :MMEMory Subsystem

The Mass Memory subsystem contains functions that provide access to the instrument's setup and data storage.

:MMEMory:DELeTe <filename>

Title: Delete Setup/Measurement

Description: Removes a file specified by <filename> from the current mass storage device. <filename> should be enclosed in either single quotes (') or double quotes (" ") and it must include the file extension. Use the command MMEMory:MSIS to set the current file location.

Parameter: <filename>

Related Command: :MMEMory:STORe:STATe
:MMEMory:STORe:TRACe
:MMEMory:MSIS INTernal|USB

Front Panel

Access: Shift-7 (File), Delete, Delete Selected File

:MMEMory:LOAD:STATe <integer>,<filename>

Title: Recall Setup

Description: Recalls a previously stored instrument setup in the current save location. The setup file to be loaded is specified by <filename>. <filename> should be enclosed in either single quotes (') or double quotes (" ") and should contain a file extension ".stp". Use the command :MMEMory:MSIS to set the current save location. The <integer> parameter is not currently used, but it must be sent. Send a 1.

Parameter: <integer>, <filename>

Related Command: :MMEMory:STORe:STATe
:MMEMory:MSIS INTernal|USB

Front Panel

Access: Shift-7 (File), Recall

:MMEMory:LOAD:TRACe <integer>,<filename>

Title: Recall Measurement

Description: The instrument must be in the mode of the saved trace in order to recall that trace. Use :INSTRument:SELEct or :INSTRument:NSELEct to set the mode.

Recalls a previously stored measurement trace from the current save location. The saved measurement trace to be loaded is specified by <filename>. <filename> should be enclosed in either single quotes (') or double quotes (") and should contain a file extension. Note that the trace specified by <filename> should be available at the current save location. Use the command MMEMory:MSIS to set the current save location. The <integer> parameter is not currently used, but it must be sent. Send a 1.

File name extensions:

- “.edg” for GSM
- “.spa” for SPA
- “.wcd” for WCDMA
- “.wmxd” for WiMAX
- “.wmxe” for Mobile WiMAX
- “.vna” for Cable & Antenna
- “.cdma” for CDMA
- “.tds” for TDSCDMA
- “.evdo” for EVDO
- “.ia” for Interference Analysis
- “.cs” for Channel Scanner
- “.pm” for Power Meter
- “.tm” for Transmission Measurement
- “.lte” for LTE Analyzer

Note: Extensions not available for T1 and Hi_PM.

Parameter: <integer>, <filename>

Example: To recall trace with file name “trace”:

```
:MMEMory:LOAD:TRACe 1, "trace.spa"
```

Related Command: :MMEMory:STORe:TRACe
:MMEMory:STORe:TRACe
:MMEMory:MSIS INTernal|USB

Front Panel

Access: Shift-7 (File), Recall Measurement

:MMEMory:STORe:DATA <file name>

Title: Save DAT Measurement

Description: Stores the trace into a .dat file specified by <file name>. <file name> should be enclosed in either single quotes (') or double quotes (") and should **not** contain a file extension. Use the command MMEMory:MSIS to set the current save location.

Parameter: <file name>

Example: To save the trace into the file name "trace":

```
:MMEMory:STORe:DATA "trace"
```

Related Command: :MMEMory:STORe:TRACe
:MMEMory:LOAD:TRACe
:MMEMory:MSIS INTernal|USB

Front Panel

Access: Shift-7 (File), Save

:MMEMory:STORe:STATe <integer>,<filename>

Title: Save Setup

Description: Stores the current setup into the file specified by <filename>. <filename> should be enclosed in either single quotes (') or double quotes (") and should not contain a file extension. Use the command MMEMory:MSIS to set the current save location. The <integer> parameter is not currently used, but it must be sent. Send a value of 0.

Parameter: <integer>, <filename>

Related Command: :MMEMory:LOAD:STATe
:MMEMory:MSIS INTernal|USB

Front Panel

Access: Shift-7 (File)

:MMEMory:STORe:TRACe <integer>,<filename>

Title: Save VNA Measurement

Description: Stores the trace into a ,vna file specified by <filename>. <filename> should be enclosed in either single quotes (') or double quotes (") and should not contain a file extension. Use the command MMEMory:MSIS to set the current save location. The <integer> parameter is not currently used, but it must be sent. Send a 0. Note that existing files of the same name will not be overwritten.

Parameter: <integer>, <filename>

Example: To save the trace into the file name "trace":

```
:MMEMory:STORe:TRACe 0,"trace"
```

Related Command: :MMEMory:LOAD:TRACe
:MMEMory:MSIS INTernal|USB

Front Panel

Access: Shift-7 (File), Save

4-8 :SOURce Subsystem

The commands in this subsystem controls the internal signal source.

:SOURce:POWer LOW|HIGH

:SOURce:POWer?

Title: Power Levels

Description: Sets the power levels for the measurements.

Parameter: LOW|HIGH

Parameter Type: <char>

Default Value: HIGH

Range: LOW power ≈ -35 dBm, HIGH power ≈ 0 dBm

Front Panel

Access: Shift-3 (Sweep), Output Power

4-9 :TRACe Subsystem

This subsystem contains commands related to the transfer of trace data to and from the instrument.

:TRACe:PREamble? [1]

Title: Trace Header Transfer

Description: Returns trace header information for the trace. Use the commands in the MMEMory subsystem to store and recall traces from the instrument memory. The response begins with an ASCII header. The header specifies the number of following bytes. It looks like #AX, where A is the number of digits in X and X is the number of bytes that follow the header. Parameters are returned in comma-delimited ASCII format. Each parameter is returned as "NAME=VALUE[UNITS]," Note that currently only Trace A header is retrieved. Valid parameters are shown in "[Cable & Antenna Parameter Names](#)" on page 2-18.

Parameter: [1]

Related Command: :TRACe:DATA

:TRACe[:DATA]? [1]

Title: Trace Data Query

Description: Transfers the current active trace data from the instrument to the controller. The format of the block data that is returned can be specified by the command :FORMat:DATA. The block data in the command form is always sent in ASCII format.

The response begins with an ASCII header that specifies the number of data bytes. It looks like #AX, where A is the number of digits in X and X is the number of bytes that follow the header. The returned block data is separated by comma delimiters. Except for the group delay, each data point consists of a real and imaginary pair scaled by 10^6 . For example:
137 point trace returns a total of 1102 data points. The values are returned in threes, fours, and in fives (every 8n-1,8n data point should reconstruct the original trace points).

275 point trace returns a total of 1102 data points. The values are returned in twos (repeated once) with the last value in threes.

551 point trace returns a total of 1102 data points.

1102 point trace returns a total of 2204 data points.

2204 point trace returns a total of 4408 data points.

Trace setup information can be acquired using
:TRACe[:DATA]:PREamble?

Parameter: [1]

Related Command: :FORMat[:READings][:DATA]
:TRACe[:DATA]:PREamble?

4-10 [:SENSe] Subsystem

The commands in this subsystem relate to device-specific parameters, not signal-oriented parameters.

[:SENSe]:AVERage:CLEar

Title: Restart Averaging

Description: Clears and restarts averaging of the measurement data. Note that averaging state must be ON for averaging to restart.

Related Command: [:SENSe]:AVERage[:STATe]

Front Panel

Access: Shift-3 (Sweep), Averaging Smoothing, Restart

[:SENSe]:AVERage:COUNT <integer>

[:SENSe]:AVERage:COUNT?

Title: Number of Traces to Average

Description: Sets the number of traces to average.

Parameter: <integer>

Parameter Type: <integer>

Default Value: 10

Range: 2 to 65535

Front Panel

Access: Shift-3 (Sweep), Averaging Smoothing, Averaging Factor

[:SENSe]:AVERage[:STATe] OFF|ON|0|1

[:SENSe]:AVERage[:STATe]?

Title: Averaging State

Description: Turns trace averaging ON or OFF. Setting the value to ON or 1 will result in turning trace averaging ON.

Parameter: OFF|ON|0|1

Parameter Type: <boolean>

Default Value: OFF

Front Panel

Access: Shift-3 (Sweep), Averaging Smoothing, Averaging

[:SENSE]:CORRection:COLLect:ABORt

Title: Calibration Abort

Description: Aborts the calibration measurement and restarts the current sweep and/or measurement.

Related Command: [:SENSE]:CORRection:COLLect:INITialize
[:SENSE]:CORRection:COLLect:OPEN
[:SENSE]:CORRection:COLLect:SHOR
[:SENSE]:CORRection:COLLect:LOAD

[:SENSE]:CORRection:COLLect:INITialize

Title: Calibration Initialize

Description: Shift-2 (Calibrate), Configure DUT User, Short Initiates the calibration process. This command must be issue before sending Open, Short, or Load commands. Use the query command [:SENSE]:CORRection:COLLect:STATus? to check if initialization has completed and that the next calibrate step can be proceeded.

Notes:

1. Once the calibration sequence has been initialized remotely, calibration steps must be completed remotely. To exit the calibration sequence before it is completed use the ABORt command.
2. During calibration Data Points is set to 551. Set to desired Data Points value after calibration is completed.

Related Command: [:SENSE]:CORRection:COLLect:STATus?
[:SENSE]:CORRection:COLLect:OPEN
[:SENSE]:CORRection:COLLect:SHORT
[:SENSE]:CORRection:COLLect:LOAD
[:SENSE]:CORRection:COLLect:ABORt

[:SENSE]:CORRection:COLLect:LOAD

Title: Calibration Load

Description: Starts the Load calibration measurement. This is the last calibration step for 1-Port (OSL) calibration. Note that the Calibration Short process must be completed before calling this command. You must also connect the Load to the RF Out port (or to the end of the test port extension cable) prior to issuing this command. Use the query command [:SENSE]:CORRection:COLLect:STATus? to check if the Load calibration measurement has completed and that the next calibrate step can be proceeded.

Related Command: [:SENSE]:CORRection:COLLect:STATus?
[:SENSE]:CORRection:COLLect:INITialize
[:SENSE]:CORRection:COLLect:OPEN
[:SENSE]:CORRection:COLLect:SHORT

[:SENSe]:CORRection:COLLect:OPEN

Title: Calibration Open

Description: Starts the Open calibration measurement. This is the first calibration step for the 1-Port (Open-Short-Load) calibration. Note that the initialize step [:SENS]:CORR:COLL:INIT must be completed before calling this command. Note that you must connect the Open to the RF Out port (or to the end of the test port extension cable) before issuing this command. Use the query command [:SENSe]:CORRection:COLLect:STATus? to check if the Open calibration measurement has completed and that the next calibrate step can be proceeded.

Related Command: [:SENSe]:CORRection:COLLect:STATus?
[:SENSe]:CORRection:COLLect:INITialize,

[:SENSe]:CORRection:COLLect:SHORT

Title: Calibration Short

Description: Starts the Short calibration measurement. This is the second calibration step for the 1-Port (Open-Short-Load) calibration. Note that the Calibration Open process must be completed before calling this command. You must also connect the Short to the RF Out port (or to the end of the test port extension cable) before issuing this command. Use the query command [:SENSe]:CORRection:COLLect:STATus? to check if the Short calibration measurement has completed and that the next calibrate step can be proceeded.

Related Command: [:SENSe]:CORRection:COLLect:STATus?
[:SENSe]:CORRection:COLLect:INITialize
[:SENSe]:CORRection:COLLect:OPEN
[:SENSe]:CORRection:COLLect:LOAD

[:SENSE]:CORRection:COLLect:STATus?**[INITialize|OPEN|SHORT|LOAD]**

Title: Calibration Status

Description: This command requests information about the current calibration step or the specified calibration step. If no calibration step is specified, then it returns a 1 if the current calibration step has completed, otherwise it returns a 0. If INITialized is specified, then the command returns a 1 if the Initialize step has completed and returns a 0 if it has not been completed. If OPEN is specified, then the command returns a 1 if the Open step has completed and returns a 0 if it has not been completed. If SHORT is specified, then the command returns a 1 if the Short step has completed and returns a 0 if it has not been completed. If LOAD is specified, then the command returns a 1 if the Load step has completed and returns a 0 if it has not been completed.

Parameter: INITialize| OPEN|SHORT|LOAD

Parameter Type: <char>

Range: INITialize| OPEN|SHORT|LOAD

Related Command: [:SENSE]:CORRection:COLLect:INITialize
 [:SENSE]:CORRection:COLLect:OPEN
 [:SENSE]:CORRection:COLLect:SHORT
 [:SENSE]:CORRection:COLLect:LOAD

[:SENSE]:CORRection:INSTacal:CALibrate

Title: Insta-Calibration.

Description: Triggers a Remote InstaCal. An InstaCal (ICN50, or ICN50B) must be connected before running this command. This command returns the string 'DONE' if it is completed successfully. Otherwise, it will return one of the following strings indicating an error: 'ICM_COMM_ERROR', 'ICM_BAUD_ERROR', 'ICM_DWNLD_ERROR', 'ICM_FREQ_RANGE_ERROR'.

Front Panel

Access: Shift-2 (Calibrate), Start Cal.

[:SENSE]:CORRection:TYPE STANDARD|FLEX**[:SENSE]:CORRection:TYPE?**

Title: Calibration Type

Description: Set Calibration type - Standard, or Flex.

Parameter: STANDARD|FLEX

Parameter Type: <char>

Front Panel

Access: Shift-2 (Calibrate), Cal Type

[:SENSe]:FREQuency:CABLe <index>

Title: Cable Selection

Description: Sets the cable selection to the <index> in the cable list for the DTF measurement.

Parameter: <index>

Front Panel

Access: Freq/Dist, More, Cable (Note: For DTF measurements only.)

[:SENSe]:FREQuency:LINK UPLINK|DOWNLINK|UPANDDWNLINK**[:SENSe]:FREQuency:LINK?**

Title: Signal Standard Link

Description: Set “Link” signal standard parameter.

Parameter: UPLINK|DOWNLINK|UPANDDWNLINK

Parameter Type: <char>

Front Panel

Access: Freq/Dist, Signal Standard, UpLink/DownLink/UpLink plus DownLink

[:SENSe]:FREQuency:SIGStandard:NAME <string>**[:SENSe]:FREQuency:SIGStandard:NAME?**

Title: Signal Standard

Description: Selects the desired signal standard from the list. The <string> argument is the name of the desired signal standard as displayed in the instrument’s current signal standard list. The list can be displayed on the instrument by choosing the Signal Standard submenu button in the Freq menu and then pressing the Select Standard submenu button in the Signal Standard menu. The list can also be downloaded remotely and viewed using Anritsu Master Software Tools. For example, if the desired Signal Standard is P-GSM 900(A), then the value of the <string> argument would be “P-GSM 900(A)”.

To select Uplink / Downlink / Uplink plus Downlink, use the command [:SENSe]:FREQuency:LINK.

The query form of this command will return the name of the currently selected signal.

Standard on the list. To query the link status, use the command [:SENSe]:FREQuency:LINK?

Parameter: <string>

Front Panel

Access: Freq/Dist, Signal Standard, Select Standard

[:SENSe]:FREQUENCY:START <freq>

[:SENSe]:FREQUENCY:START?

Title: Start Frequency

Description: Sets the start frequency. Note that in the spectrum analyzer, changing the value of the start frequency will change the value of the coupled parameters, Center Frequency and Span. Note that in Cable & Antenna mode, changing the value of the start frequency may affect the DTF distance range.

Parameter: <freq>

Default Value: 2 MHz

Default Unit: Hz

Range: (based on model, refer to the instrument's User Guide)

Related Command: [:SENSe]:FREQUENCY:STOP?

Front Panel

Access: Freq/Dist, Start Freq

[:SENSe]:FREQUENCY:STOP <freq>

[:SENSe]:FREQUENCY:STOP?

Title: Stop Frequency

Description: Sets the stop frequency. Note that in the spectrum analyzer, changing the value of the stop frequency will change the value of the coupled parameters, Center Frequency and Span. Note that in Cable & Antenna mode, changing the value of the start frequency may affect the DTF distance range. Note that the set command is available only if the instrument is in Cable & Antenna mode.

Parameter: <freq>

Default Value: (based on model, refer to the instrument's User Guide)

Default Unit: Hz

Range: (based on model, refer to the instrument's User Guide)

[:SENSe]:SWEep:RESolution LOW|MEDium|HIGH|1102|2204

[:SENSe]:SWEep:RESolution?

Title: Sweep Resolution

Description: This command sets the sweep resolution (in other words, the number of sweep data points). Valid resolution settings are 137, 275, 551, 1102, 2204.

Note Lower sweep resolutions yeild faster sweep times.

Parameter: 137|275|551|1102|2204

Parameter Type: <char>

Default Value: 275

Front Panel

Access: Shift-3 (Sweep), Data Points

[:SENSe]:SWEep:RFIMmunity 0|1

[:SENSe]:SWEep:RFIMmunity?

Title: RF Immunity

Description: Sets RF Immunity. Set value to 1 for Low RF Immunity and 0 for High RF Immunity. Note that a sweep with RF immunity enabled with be slightly slower than a sweep with RF immunity disabled.

Parameter: 0|1

Parameter Type: <boolean>

Default Value: High

Front Panel

Access: Shift-3 (Sweep), RF Immunity

Chapter 5 — Spectrum Analyzer Commands

5-1 :ABORt Subsystem

The abort subsystem includes commands that allow the user to stop current measurement activities on the instrument.

:ABORt

Title: Abort

Description: Restarts the current sweep and/or measurement. Resets the trigger system. If :INITiate:CONTinuous is OFF (i.e. the instrument is in single sweep mode), send the command :INITiate[:IMMediate] to trigger the next sweep. If :INITiate:CONTinuous is ON (i.e. the instrument is in continuous sweep mode), a new sweep will start immediately.

Parameter: NA

Related Command: :INITiate:CONTinuous
:INITiate[:IMMediate]

5-2 :CALCulate Subsystem

The commands in this subsystem process data that has been collected via the SENSE subsystem.

:CALCulate:LIMit:ALARm OFF|ON|0|1

:CALCulate:LIMit:ALARm?

Title: Limit Alarm

Description: Enables/disables the currently active limit line alarm. Setting the value to ON or 1 will turn on the limit alarm. Setting the value to OFF or 0 will turn off the limit alarm. The query version of the command returns a 1 if the currently selected limit line alarm is set to ON and returns 0 if OFF. Use :CALCulate:LIMit:TYPE to set the currently active limit line.

Parameter: OFF|ON|0|1

Parameter Type: <boolean>

Default Value: OFF

Example: To turn off limit alarm:

```
:CALCulate:LIMit:ALARm OFF
:CALCulate:LIMit:ALARm 0
```

To turn on limit alarm:

```
:CALCulate:LIMit:ALARm ON
:CALCulate:LIMit:ALARm 1
```

Related Command: :CALCulate:LIMit:TYPE

Front Panel

Access: Shift-6 (Limit), Limit Alarm

:CALCulate:LIMit:CENTer

Title: Move Limit to Current Center Frequency

Description: Moves the center of the current active limit line to the center frequency.

Example: To move the limit to the current center:

```
:CALCulate:LIMit:CENTer
```

Front Panel

Access: Shift-6 (Limit), Limit Move, Move Limit to Current Center Freq

:CALCulate:LIMit:ENVELOpe:CREate

Title: Create Limit Envelope

Description: Creates a limit envelope. This generates a limit line that formed a mask just above or below the existing signals. Note that this command will turn on the currently selected limit line if it is not already on. Use :CALCulate:LIMit:TYPE to set the currently active limit line.

Example: To create a limit envelope:

```
:CALCulate:LIMit:ENVELOpe:CREate
```

Front Panel

Access: Shift-6 (Limit), Limit Envelope, Create Envelope

:CALCulate:LIMit:ENVELOpe:OFFSet <amplitude>**:CALCulate:LIMit:ENVELOpe:OFFSet?**

Title: Limit Envelope Offset

Description: Sets limit envelope offset. This defines how far away from the measured signal the active limit envelope is placed. Use :CALCulate:LIMit:TYPE to set the currently active limit line.

Parameter: <amplitude>

Default Value: 3 dB for upper limit, -3 dB for lower limit

Default Unit: dB

Range: -100 dB to 100 dB

Example: To set the limit envelope offset to 5dB:

```
:CALCulate:LIMit:ENVELOpe:OFFSet 5
```

Front Panel

Access: Shift-6 (Limit), Limit Envelope, Upper Offset (If Limit is toggled to Upper)
Shift-6 (Limit), Limit Envelope, Lower Offset (If Limit is toggled to Lower)

:CALCulate:LIMit:ENVELOpe:POINT <number>

:CALCulate:LIMit:ENVELOpe:POINT?

Title: Number of Limit Envelope Points

Description: Sets the number of inflection point for the currently active limit envelope. Use :CALCulate:LIMit:TYPE to set the currently active limit line. If the active limit shape is square, the number of inflection points must be even; attempting to set an odd value will result in that value being rounded down to the nearest even number.

Parameter: <number>

Default Value: 21 if limit shape is sloped; 20 if limit shape is square

Range: 2 to 41

Example: To set the number of inflection point to 30:

```
:CALCulate:LIMit:ENVELOpe:POINT 30
```

Front Panel

Access: Shift-6 (Limit), Limit Envelope, Upper Points (If Limit is toggled to Upper)
Shift-6 (Limit), Limit Envelope, Lower Points (If Limit is toggled to Lower)

:CALCulate:LIMit:ENVELOpe:SHAPE SQUare|SLOPe

:CALCulate:LIMit:ENVELOpe:SHAPE?

Title: Limit Envelope Shape

Description: Sets the currently active limit envelope shape.

Parameter: SQUare|SLOPe

Parameter Type: <char>

Example: To set the limit envelope to a square:

```
:CALCulate:LIMit:ENVELOpe:SHAPE SQUare
```

Front Panel

Access: Shift-6 (Limit), Limit Envelope, Upper Shape (If Limit is toggled to Upper) or Lower Shape (If Limit is toggled to Lower)

:CALCulate:LIMit:ENVELOpe:UPDate:Y

Title: Update Limit Envelope Amplitude

Description: Updates the amplitude of the current limit without changing the frequencies of the inflection point. Use :CALCulate:LIMit:TYPE to set the currently active limit line.

Example: To adjust the limit envelope amplitude:

```
:CALCulate:LIMit:ENVELOpe:UPDate:Y
```

Front Panel

Access: Shift-6 (Limit), Limit Envelope, Update Envelope Amplitude

:CALCulate:LIMit:FAIL?

Title: Limit Fail State

Description: Query whether the currently active limit line (upper or lower) has failed or not. The command returns a 0 on success, 1 on fail, and 2 if the current active limit is OFF or the alarm is OFF. Use :CALCulate:LIMit:TYPE to set the currently active limit line.

:CALCulate:LIMit:LOWer:ALARm OFF|ON|0|1**:CALCulate:LIMit:LOWer:ALARm?**

Title: Lower Limit Alarm

Description: Enables/disables the lower limit alarm. It is a combination of the commands :CALCulate:LIMit:TYPE 1 and :CALCulate:LIMit:ALARm ON|OFF. Setting the value to ON or 1 will turn on the lower limit alarm. Setting the value to OFF or 0 will turn off the lower limit alarm. The query version of the command returns a 1 if the lower limit line alarm is ON and returns 0 if OFF. Note that using this command set the lower limit line active for editing.

Parameter: OFF|ON|0|1

Parameter Type: <boolean>

Default Value: OFF

Related Command: :CALCulate:LIMit:ALARm

Front Panel

Access: Shift-6 (Limit), Limit Alarm

:CALCulate:LIMit:LOWer:FAIL?

Title: Lower Limit Fail State

Description: Query whether the lower limit line has failed or not. The command returns a 0 on success, 1 on fail, and 2 if the lower limit line is OFF or the alarm is OFF.

:CALCulate:LIMit:LOWer:POINT?

Title: Number of Lower Limit Points

Description: Returns the number of points currently in the lower limit line.

Default Value: 2

Related Command: :CALCulate:LIMit:POINT?

:CALCulate:LIMit:LOWer[:STATe] OFF|ON|0|1
:CALCulate:LIMit:LOWer[:STATe]?

Title: Lower Limit State

Description: Turns the lower limit line ON or OFF. It is a combination of the commands :CALCulate:LIMit:TYPE 1 and :CALCulate:LIMit:STATe ON|OFF. The query version of the command returns a 1 if the lower limit line is ON and returns a 0 if OFF.

Parameter: OFF|ON|0|1

Parameter Type: <boolean>

Default Value: OFF

Example: To turn on lower limit:

```
:CALCulate:LIMit:LOWer ON
:CALCulate:LIMit:LOWer 1
:CALCulate:LIMit:LOWer:STATe ON
```

To turn off lower limit:

```
:CALCulate:LIMit:LOWer OFF
:CALCulate:LIMit:LOWer 0
:CALCulate:LIMit:LOWer:STATe 0
```

Related Command: :CALCulate:LIMit:ALARm

Front Panel

Access: Shift-6 (Limit), Limit Lower, Limit On/Off

:CALCulate:LIMit:LTYPE ABSolute|RELative
:CALCulate:LIMit:LTYPE?

Title: Limit Line Type

Description: Sets the currently active limit line type. Absolute limit lines set the limit inflection points based upon the entered frequencies for each point. Relative limit lines set the limit inflection points relative to the current center frequency.

Parameter: ABSolute|RELative

Parameter Type: <char>

Default Value: ABSolute

Range: ABSolute|RELative

Example: To set the limit line type to relative:

```
:CALCulate:LIMit:LTYPE RELative
```

Related Command: :CALCulate:LIMit[:STATe]

Front Panel

Access: Shift-6 (Limit), Limit Advanced, Limit Line Type

:CALCulate:LIMit:MIRRor

Title: Limit Mirror

Description: Creates a limit mirror. Use :CALCulate:LIMit:TYPE to set the currently active limit line.

Related Command: :CALCulate:LIMit:TYPE

:CALCulate:LIMit:POINT:ADD

Title: Add Limit Point

Description: Adds a new limit point to the currently active limit line. Use :CALCulate:LIMit:TYPE to set the currently active limit line.

Related Command: :CALCulate:LIMit:TYPE

Front Panel

Access: Shift-6 (Limit), Limit Edit, Add Point

:CALCulate:LIMit:POINT:DELeTe

Title: Delete Limit Point

Description: Deletes the currently active limit point. The active point becomes the point that is immediately to the left of the point that was deleted. Note that deletion is only valid if there are more than 2 limit points. Use :CALCulate:LIMit:TYPE to set the currently active limit line.

Example: To delete the currently active limit point:

```
:CALCulate:LIMit:POINT:DELeTe
```

Front Panel

Access: Shift-6 (Limit), Limit Edit, Delete Point

:CALCulate:LIMit:POINT:LEFT

Title: Next Point Left

Description: Selects the limit point immediately to the left of the active point, making it active for editing or deleting. Use :CALCulate:LIMit:TYPE to set the currently active limit line.

Example: To select the point to the left of the active point:

```
:CALCulate:LIMit:POINT:LEFT
```

Front Panel

Access: Shift-6 (Limit), Limit Edit, Next Point Left

:CALCulate:LIMit:POINt:RIGHT

Title: Next Point Right

Description: Selects the limit point immediately to the right of the active point, making it active for editing or deleting. Use :CALCulate:LIMit:TYPE to set the currently active limit line.

Example: To select the point to the right of the active point:

```
:CALCulate:LIMit:POINt:RIGHT
```

Front Panel

Access: Shift-6 (Limit), Limit Edit, Next Point Right

:CALCulate:LIMit:POINt:X <x-parameter>**:CALCulate:LIMit:POINt:X?**

Title: Limit Point X Value

Description: Sets the location of the active limit point on the x-axis at the specified location. <x-parameter> is defined in the current x-axis. Note that this will change the Move Limit on the front panel to Point if it is currently set to Limit. The query version of the command returns the location of the active limit point on the x-axis. Use :CALCulate:LIMit:TYPE to set the currently active limit line.

Parameter: <x-parameter>

Default Unit: Hz or for zero span in seconds

Example: To set the active point to 5 Hertz:

```
:CALCulate:LIMit:POINt:X 5  
:CALCulate:LIMit:POINt:X 5Hz
```

To set the active point to 500 MHz:

```
:CALCulate:LIMit:POINt:X 500MHz
```

Front Panel

Access: Shift-6 (Limit), Limit Edit, Frequency

:CALCulate:LIMit:POINT:Y <y-parameter>

:CALCulate:LIMit:POINT:Y?

Title: Limit Point Y Value

Description: Sets the location of the active limit point on the y-axis at the specified location. <y-parameter> is defined in the current y-axis. Note that this will change the Move Limit on the front panel to Point if it is currently set to Limit. The query version of the command returns the location of the active limit point on the y-axis. Use :CALCulate:LIMit:TYPE to set the currently active limit line.

Parameter: <y-parameter>

Default Unit: Current y-axis unit.

Example: To set the active point to 5dBm:

```
:CALCulate:LIMit:POINT:Y 5
```

(If y-axis unit is dBm)

```
:CALCulate:LIMit:POINT:Y 5dBm
```

Front Panel

Access: Shift-6 (Limit), Limit Edit, Amplitude

:CALCulate:LIMit:POINT?

Title: Number of Limit Points

Description: Returns the number of points currently in the selected limit line. Use :CALCulate:LIMit:TYPE to set the currently active limit line.

Related Command: :CALCulate:LIMit:TYPE

:CALCulate:LIMit:TYPE 0|1

:CALCulate:LIMit:TYPE?

Title: Set Limit Line Upper or Lower

Description: Sets the currently active limit line to either upper or lower. Subsequent limit line operations will be performed on the selected limit line.

Parameter: 0|1 (0 = upper limit line, 1 = lower limit line)

Parameter Type: number

Default Value: 0 (upper)

Range: 0|1

Example: To set the active limit line to upper:

```
:CALCulate:LIMit:TYPE 0
```

Related Command: :None

Front Panel

Access: Shift-6 (Limit), Limit

:CALCulate:LIMit:UPPer:ALARm OFF|ON|0|1

:CALCulate:LIMit:UPPer:ALARm?

Title: Upper Limit Alarm

Description: Enables/disables the alarm for the upper limit. It is a combination of the commands :CALCulate:LIMit:TYPE 0 and :CALCulate:LIMit:ALARm ON|OFF. Setting the value to ON or 1 will turn on the upper limit alarm. Setting the value to OFF or 0 will turn off the upper limit alarm. The query version of the command returns a 1 if the upper limit line alarm is ON and returns 0 if OFF.

Parameter: OFF|ON|0|1

Parameter Type: <boolean>

Default Value: OFF

Related Command: :CALCulate:LIMit:ALARm

Front Panel

Access: Shift-6 (Limit), Limit Alarm

:CALCulate:LIMit:UPPer:FAIL?

Title: Upper Limit Fail State

Description: Query whether the upper limit line has failed or not. The command returns a 0 on success, 1 on fail, and 2 if the upper limit line is OFF or the alarm is OFF. Note that the condition is reset after the end of the sweep. To avoid missing a failing condition, send the command after completing a single sweep.

:CALCulate:LIMit:UPPer:POINT?

Title: Number of Upper Limit Points

Description: Returns the number of points currently in the upper limit line.

Default Value: 2

Related Command: :CALCulate:LIMit:POINT?

:CALCulate:LIMit:UPPer[:STATe] OFF|ON|0|1
:CALCulate:LIMit:UPPer[:STATe]?

Title: Upper Limit State

Description: Turns the upper limit line ON or OFF. It is a combination of the commands :CALCulate:LIMit:TYPe 0 and :CALCulate:LIMit:STATe ON|OFF. The query version of the command returns a 1 if the upper limit line is ON and returns a 0 if OFF.

Parameter: OFF|ON|0|1

Parameter Type: <boolean>

Default Value: OFF

Example: To turn on upper limit:

```
:CALCulate:LIMit:UPPer ON
:CALCulate:LIMit:UPPer 1
:CALCulate:LIMit:UPPer:STATe ON
```

To turn off upper limit:

```
:CALCulate:LIMit:UPPer OFF
:CALCulate:LIMit:UPPer 0
:CALCulate:LIMit:UPPer:STATe 0
```

Related Command: :CALCulate:LIMit[:STATe]

Front Panel

Access: Shift-6 (Limit), On/Off

:CALCulate:LIMit:VALue <value>

Title: Move Limit

Description: Sets the currently active limit line value. This command moves an entire single or multi-segment limit line up or down by the given <value>. If the front panel Move Limit button (Shift-6, Limit Move, Move Limit) is pressed, the limit line will move to the given <value>. This command is equivalent to the command :CALCulate:LIMit:Y. Use :CALCulate:LIMit:TYPe to set the currently active limit line.

Note that this will change the Move Limit on the front panel to Limit if it is currently set to Point.

Parameter: <value>

Default Unit: Current y-axis unit.

Related Command: :CALCulate:LIMit:Y
:CALCulate:LIMit:TYPe

Front Panel

Access: Shift-6 (Limit), Limit Edit, Amplitude

:CALCulate:LIMit:VERTical:ADD

Title: Add Vertical

Description: Adds vertical. This will add two inflection points that share the same frequency and are centered midpoint between adjacent points. Use :CALCulate:LIMit:TYPe to set the currently active limit line.

Related Command: :CALCulate:LIMit:TYPe

Front Panel

Access: Shift-6 (Limit), Limit Edit, Add Vertical

:CALCulate:LIMit:X <x-parameter>

Title: Limit X Value

Description: Sets the location of the active limit line on the x-axis at the specified location. This moves the entire limit and moves the active limit point to the given value. <x-parameter> is defined in the current x-axis. Note that this will change the Move Limit on the front panel to Limit if it is currently set to Point. Use :CALCulate:LIMit:TYPe to set the currently active limit line.

Parameter: <x-parameter>

Default Unit: Hz or for zero span in seconds

Example: To move the limit and set active point to 5 Hz:

```
:CALCulate:LIMit:X 5
:CALCulate:LIMit:X 5Hz
```

To move the limit and set active point to 500 MHz:

```
:CALCulate:LIMit:X 500MHz
```

Front Panel

Access: Shift-6 (Limit), Limit Edit, Frequency

:CALCulate:LIMit:Y <y-parameter>

Title: Limit Line Y Value

Description: Sets the location of the active limit line on the y-axis at the specified location. This moves the entire limit and moves the current active limit point by the given value. <y-parameter> is defined in the current y-axis. Note that this will change the Move Limit on the front panel to Limit if it is currently set to Point. Use :CALCulate:LIMit:TYPe to set the currently active limit line.

Parameter: <y-parameter>

Default Unit: Current y-axis unit.

Example: To move limit and set the active point to 5 dbm:

```
:CALCulate:LIMit:Y 5
```

(If y-axis unit is dBm)

```
:CALCulate:LIMit:Y 5dBm
```

Front Panel

Access: Shift-6 (Limit), Limit Edit, Amplitude

:CALCulate:LIMit[:SET]:DEFault

Title: Set Default Limit

Description: Deletes all limit points for the currently active limit line and sets the default limit line value. Note that this command will turn on the currently selected limit line if it is not already on. The current selected limit line can be modified by using the command :CALCulate:LIMit:TYPE.

Example: To set the default limit line:

```
:CALCulate:LIMit[:SET]:DEFault
:CALCulate:LIMit:DEFault
```

Front Panel

Access: Shift-6 (Limit), Set Default Limit

:CALCulate:LIMit[:STATE] OFF|ON|0|1

:CALCulate:LIMit[:STATE]?

Title: Limit State

Description: Turns the currently selected limit line (upper or lower) ON or OFF. If the value is set to ON or 1, the currently selected limit line is ON. If the value is set to OFF or 0, the currently selected limit line is OFF. The query version of the command returns a 1 if the currently selected limit line is ON and returns a 0 if OFF. Use :CALCulate:LIMit:TYPE to set the currently active limit line.

Parameter: OFF|ON|0|1

Parameter Type: <boolean>

Default Value: OFF

Example: To turn on the currently selected limit line:

```
:CALCulate:LIMit ON
:CALCulate:LIMit:STATE ON
:CALCulate:LIMit:STATE 1
```

To turn off the currently selected limit line:

```
:CALCulate:LIMit OFF
:CALCulate:LIMit:STATE 0
:CALCulate:LIMit 0
```

Front Panel

Access: Shift-6 (Limit), On/Off

:CALCulate:MARKer:AOff

Title: Turn All Markers Off

Description: Turns off all markers.

Front Panel

Access: Marker, More, All Markers Off

:CALCulate:MARKer:PEAK:THReshold <percentage>**:CALCulate:MARKer:PEAK:THReshold?**

Title: Peak Threshold

Description: Sets the peak/valley threshold as a percentage of the display.
:CALCulate:MARKer:MAXimum:LEFT and
:CALCulate:MARKer:MAXimum:RIGHT use this value to determine
whether a particular display point qualifies as a peak.

Parameter: <percentage>

Default Value: 10

Default Unit: %

Range: 0% to 100%

Front Panel

Access: Marker, More Peak Options, Peak Threshold

:CALCulate:MARKer:TABLE[:STATE] OFF|ON**:CALCulate:MARKer:TABLE[:STATE]?**

Title: Marker Table State

Description: Turns the Marker Table on or off. Setting the value to ON will turn on
the marker table. Setting the value to OFF will turn off the marker
table.

Parameter: OFF|ON

Parameter Type: <boolean>

Default Value: OFF

Example: To turn on marker table:

:CALCulate:MARKer:TABLE ON

Front Panel

Access: Marker, More, Marker Table

```
:CALCulate:MARKer{1|2|3|4|5|6}:DELTA:NOISE[:STATE]
OFF|ON|0|1
:CALCulate:MARKer{1|2|3|4|5|6}:DELTA:NOISE[:STATE]?
```

Title: Marker Noise

Description: Turns the delta marker noise on or off. Note that if counter marker is set to on when setting marker noise to on, then counter marker is set to off. This command is not valid in zero span. The query version of this command returns a 1 if the specified delta marker is noise marker and returns a 0 if not.

Parameter: OFF|ON|0|1

Parameter Type: <boolean>

Default Value: OFF

Example: To turn on marker noise for delta marker #1:

```
:CALCulate:MARKer1:DELTA:NOISE ON
:CALCulate:MARKer1:DELTA:NOISE 1
:CALCulate:MARKer:DELTA:NOISE 1
:CALCulate:MARKer:DELTA:NOISE:STATE ON
```

To turn on marker noise for delta marker #2:

```
:CALCulate:MARKer2:DELTA:NOISE ON
:CALCulate:MARKer2:DELTA:NOISE 1
:CALCulate:MARKer2:DELTA:NOISE:STATE ON
```

To turn off marker noise #5:

```
:CALCulate:MARKer5:DELTA:NOISE OFF
:CALCulate:MARKer5:DELTA:NOISE 0
:CALCulate:MARKer5:DELTA:NOISE:STATE OFF
```

Front Panel

Access: Marker, More, Marker Noise

```
:CALCulate:MARKer{1|2|3|4|5|6}:DELTA:X <x-parameter>
:CALCulate:MARKer{1|2|3|4|5|6}:DELTA:X?
```

Title: Delta Marker X Value

Description: Sets the location of the delta marker on the x-axis at the specified location <x-parameter> + the reference marker x-axis. <x-parameter> is defined in the current x-axis units. The query version of the command returns the location of the delta marker on the x-axis.

Parameter: <x-parameter>

Default Unit: Hz or seconds if in zero span

Example: If both the reference and delta marker #1 is currently at 1 GHz on the x-axis, send the command below to set the delta marker #1 to 2 GHz on the x-axis:

```
:CALCulate:MARKer1:DELTA:X 1GHZ
```

(In zero span) If both the reference and delta marker #1 is currently at 25 us on the x-axis, send the command below to set the delta marker to 50us on the x-axis:

```
:CALCulate:MARKer1:DELTA:X 25us
```

Related Command: `:CALCulate:MARKer[1]|2|3|4|5|6:X`

Front Panel

Access: Marker, Delta

:CALCulate:MARKer{1|2|3|4|5|6}:DELTA:Y?

Title: Delta Marker Read Y Value

Description: Reads the current absolute Y value for the specified delta marker. The units are the units of the y-axis.

Default Unit: Current y-axis unit

:CALCulate:MARKer{1|2|3|4|5|6}:DELTA[:SET]:SPAN

Title: Delta Marker to Span

Description: Sets the total span width to the value of the specified delta marker. Note that this command is valid only if delta marker is on.

Example: To set the span to the value of delta marker #4:

```
:CALCulate:MARKer4:DELTA:SPAN
```

Front Panel

Access: Marker, More Peak Options, Delta Marker to Span

:CALCulate:MARKer{1|2|3|4|5|6}:DELTA[:STATE] OFF|ON|0|1 **:CALCulate:MARKer{1|2|3|4|5|6}:DELTA[:STATE]?**

Title: Delta Marker State

Description: Sets the specified delta marker on or off.

Parameter: OFF|ON|0|1

Parameter Type: <boolean>

Default Value: OFF

Example: To turn on delta marker #3:

```
:CALCulate:MARKer3:DELTA ON
:CALCulate:MARKer3:DELTA 1
:CALCulate:MARKer3:DELTA:STATE ON
:CALCulate:MARKer3:DELTA:STATE 1
```

To turn off delta marker #6

```
:CALCulate:MARKer6:DELTA OFF
:CALCulate:MARKer6:DELTA:STATE OFF
:CALCulate:MARKer6:DELTA:STATE 0
```

Front Panel

Access: Marker, Delta

:CALCulate:MARKer{1|2|3|4|5|6}:FCOUNT[:STATE] OFF|ON|0|1
:CALCulate:MARKer{1|2|3|4|5|6}:FCOUNT[:STATE]?

Title: Marker Counter

Description: Turns the marker frequency counter on or off. The marker counter is turned off when the selected marker is turned off. If delta marker is on when setting marker counter to on, then delta marker is turned off. If noise marker is set to on when setting marker counter to on, then noise marker is set to off. This command is not valid in zero span.

Parameter: OFF|ON|0|1

Parameter Type: <boolean>

Default Value: OFF

Example: To turn on frequency counter for reference marker # 2:

```
:CALCulate:MARKer2:FCOUNT ON
:CALCulate:MARKer2:FCOUNT 1
```

Front Panel

Access: Marker, More, Counter Marker

:CALCulate:MARKer{1|2|3|4|5|6}:FIXed[:STATE] OFF|ON|0|1
:CALCulate:MARKer{1|2|3|4|5|6}:FIXed[:STATE]?

Title: Marker Fixed State

Description: Sets the specified reference marker fixed state on or off. If Fixed is set to on, then the selected reference markers stay at the amplitude they were at when the marker is set to Fixed.

Parameter: OFF|ON|0|1

Parameter Type: <boolean>

Default Value: OFF

Example: To set reference marker #1 to fixed:

```
:CALCulate:MARKer:FIXed ON
:CALCulate:MARKer:FIXed 1
```

Front Panel

Access: Marker, More, Marker Style (Fixed)

:CALCulate:MARKer{1|2|3|4|5|6}:MAXimum

Title: Marker (Maximum) Peak Search

Description: Puts the specified marker at the maximum amplitude in the trace. Use Marker [1/2/3/4/5/6] to select a marker if necessary. If the selected marker is Off, then pressing Peak Search turns on that marker.

Front Panel

Access: Marker, Peak Search
Marker, More Peak Options, Peak Search
or
Marker, Marker [1/2/3/4/5/6], Peak Search
Marker, Marker [1/2/3/4/5/6], More Peak Options, Peak Search

:CALCulate:MARKer{1|2|3|4|5|6}:MAXimum:LEFT

Title: Marker (Maximum) Peak Search Left

Description: Puts the specified marker on the next highest peak to the left of the current peak. The next highest peak must be above the peak threshold. If no point meets that criterion, the marker is set to the first point on the trace.

Related Command: :CALCulate:MARKer:PEAK:THReshold

Front Panel

Access: Marker, More Peak Options, Next Peak Left

:CALCulate:MARKer{1|2|3|4|5|6}:MAXimum:NEXT

Title: Marker (Maximum) Peak Search Next

Description: Moves the marker to the highest peak anywhere in the trace which is lower than the current marker. If the given marker is not on, the command turns it on and sets it to the second highest peak in the trace. The command uses the existing peak threshold values to determine what is a peak and what is not.

Related Command: :CALCulate:MARKer:PEAK:THReshold

Front Panel

Access: None

:CALCulate:MARKer{1|2|3|4|5|6}:MAXimum:RIGHT

Title: Marker (Maximum) Peak Search Right

Description: Puts the specified marker on the next highest peak to the right of the current peak. The next highest peak must be above the peak threshold. If no point meets that criterion, the marker is set to the last point on the trace.

Related Command: :CALCulate:MARKer:PEAK:THReshold

Front Panel

Access: Marker, More Peak Options, Next Peak Right

```
:CALCulate:MARKer{1|2|3|4|5|6}:NOISE[:STATE] OFF|ON|0|1  
:CALCulate:MARKer{1|2|3|4|5|6}:NOISE[:STATE]?
```

Title: Marker Noise

Description: Turns the marker noise on or off for the specified reference marker. Note that if counter marker is set to on when setting marker noise to on, then counter marker is set to off. This command is not valid in zero span.

Parameter: OFF|ON|0|1

Parameter Type: <boolean>

Default Value: OFF

Example: To set reference marker #3 as noise marker:

```
:CALCulate:MARKer3:NOISE ON  
:CALCulate:MARKer3:NOISE 1
```

Front Panel

Access: Marker, More, Marker Noise

:CALCulate:MARKer{1|2|3|4|5|6}:X <x-parameter>

:CALCulate:MARKer{1|2|3|4|5|6}:X?

Title: Marker X Value

Description: Sets the location of the marker on the x-axis at the specified location. <x-parameter> is defined in the current x-axis units. The query version of the command returns the location of the marker on the x-axis. Note that the marker is snapped to the data point closest to the specified value. If the specified marker is not on it is set to on.

Note

Setting a marker beyond the current start frequency or stop frequency will result in an invalid power measurement.

Parameter: <x-parameter>

Default Unit: Hz or seconds if in zero span

Example: To set reference marker #2 to 5 hertz on the x-axis:

```
:CALCulate:MARKer2:X 5
:CALCulate:MARKer2:X 5Hz
```

To set reference marker #1 to 1.5 GHz on the x-axis:

```
:CALCulate:MARKer:X 1.5GHz
:CALCulate:MARKer1:X 1.5GHz
```

(In zero span) To set reference marker #3 to 1.5 seconds on the x-axis:

```
:CALCulate:MARKer3:X 1.5
:CALCulate:MARKer3:X 1.5s
```

(In zero span) To set reference marker #1 to 25 us:

```
:CALCulate:MARKer:X 25us
:CALCulate:MARKer1:X 25us
```

Front Panel

Access: Marker, Marker [1/2/3/4/5/6]

:CALCulate:MARKer{1|2|3|4|5|6}:Y?

Title: Marker Read Y Value

Description: Reads the current Y value for the specified marker. The units are the units of the y-axis.

Default Unit: Current y-axis unit

:CALCulate:MARKer{1|2|3|4|5|6}[:SET]:CENTER

Title: Marker Frequency to Center

Description: Sets the center frequency equal to the frequency of the specified marker. Note that this will result in a change to the start and stop frequencies and may also result in a change to the span. Note that this command is not valid in zero span.

Front Panel

Access: Marker, Marker Freq to Center

:CALCulate:MARKer{1|2|3|4|5|6}[:SET]:RLEVEL

Title: Marker to Reference Level

Description: Sets the reference level equal to the measured amplitude of the specified marker. Note that this may result in a change to the input attenuation.

Front Panel

Access: Marker, Marker to Ref Lvl

:CALCulate:MARKer{1|2|3|4|5|6}[:STATE] OFF|ON|0|1**:CALCulate:MARKer{1|2|3|4|5|6}[:STATE]?**

Title: Marker State

Description: Sets the specified marker on/off.

Parameter: OFF|ON|0|1

Parameter Type: <boolean>

Default Value: OFF

Example: To turn off reference marker #1:

:CALCulate:MARKer1:STATE OFF

Front Panel

Access: Marker, On/Off

5-3 :CONFigure Subsystem

This set of commands prepares the instrument for the selected measurement. It disables any currently-enabled measurements and activates the specified measurement. It sets the instrument to single sweep mode, waiting for an :INITiate command. It will not initiate the taking of a measurement.

Current instrument settings may be changed to default values. These changes are identified with their respective measurement commands.

:CONFigure:ACPower

Title: Configure Adjacent Channel Power Ratio

Description: Configures the default adjacent channel power ratio measurement. Disables any other active one-button measurements, including channel power, occupied bandwidth, AM/FM demodulation and C/I. Sets the main channel bandwidth equal to the span. Sets the adjacent channel bandwidth and channel spacing equal to the main channel bandwidth. Sets the detection method to RMS. Sets the instrument to single sweep mode (:INITiate:CONTinuous OFF). Measurement settings can be modified by using the [:SENSe]:ACPower commands before initiating a sweep.

Related Command: [:SENSe]:ACPower:STATe
[:SENSe]:ACPower:BANDwidth|BWIDth:MAIN
[:SENSe]:ACPower:BANDwidth|BWIDth:ADJacent
[:SENSe]:ACPower:BANDwidth|BWIDth:SPACing

:CONFigure:CHPower

Title: Configure Channel Power

Description: Configures the default channel power measurement. Disables any other active one-button measurements, including ACPR, occupied bandwidth, AM/FM demodulation and C/I. Sets the integration bandwidth equal to the span. Sets the detection method to RMS. Sets the instrument to single sweep mode (:INITiate:CONTinuous OFF). Measurement settings can be modified by using the [:SENSe]:CHPower commands before initiating a sweep. Note that this measurement is not valid in zero span.

Related Command: [:SENSe]:CHPower:STATe
:SENSe:CHPower:BANDwidth|BWIDth:INTegration

:CONFigure:FSTrength

Title: Configure Field Strength

Description: Configures the default field strength measurement. Disables any other active one-button measurements, including channel power, adjacent channel power, occupied bandwidth, AM/FM demodulation and C/I. Sets the antenna to the first antenna in the instrument's antenna list. Sets the instrument to single sweep mode (:INITiate:CONTinuous OFF). Measurement settings can be modified by using the [:SENSe]:FSTrength commands before initiating a sweep. Note that this measurement is not valid in zero span.

Related Command: [:SENSe]:FSTrength:ANTenna

:CONFigure:OBWidth

Title: Configure Occupied Bandwidth

Description: Configures the default occupied bandwidth measurement. Disables any other active one-button measurements, including channel power, ACPR, AM/FM demodulation and C/I. Sets the method to %. Sets the % of power to 99%. Sets the instrument to single sweep mode (:INITiate:CONTinuous OFF). Measurement settings can be modified by using the [:SENSe]:OBWidth commands before initiating a sweep. Note that this measurement is not valid in zero span.

Related Command: [:SENSe]:OBWidth:STATe
[:SENSe]:OBWidth:METHOD
[:SENSe]:OBWidth:PERCent
[:SENSe]:OBWidth:XDB

5-4 :DISPlay Subsystem

This subsystem provides commands that modify the display of data for the user. They do not modify the way in which data are returned to the controller.

:DISPlay:WINDow:TRACe:Y:ADJust

Title: Adjust Range

Description: Automatically adjusts reference level if input signal strength is too high (ADC error) or too low.

Example: :DISPlay:WINDow:TRACe:Y:ADJust

Front Panel

Access: Amplitude, Auto Ref Level

:DISPlay:WINDow:TRACe:Y[:SCALE]:PDIVision <rel ampl>

:DISPlay:WINDow:TRACe:Y[:SCALE]:PDIVision?

Title: Scale

Description: Sets the scale (dB/division) for the y-axis.

Parameter: <rel ampl>

Default Value: 10 dB/div

Default Unit: dB

Range: 1 dB to 15 dB

Front Panel

Access: Amplitude, Scale

:DISPlay:WINDow:TRACe:Y[:SCALE]:RLEVEL <amplitude>

:DISPlay:WINDow:TRACe:Y[:SCALE]:RLEVEL?

Title: Reference Level

Description: Sets the reference level amplitude value for the y-axis. Note that this may cause a change in attenuation if the automatic input attenuation coupling is enabled.

Parameter: <amplitude>

Default Value: 10 dBm

Default Unit: Current active amplitude unit

Range: With reference level offset = 0 dB: 30 dBm to -150 dBm

Example: To set the reference level to 15 dBm (If y-axis is dBm)

```
:DISPlay:WINDow:TRACe:Y:SCALE:RLEVEL 15
```

```
:DISPlay:WINDow:TRACe:Y:SCALE:RLEVEL 15dBm
```

Related Command: :DISPlay:WINDow:TRACe:Y[:SCALE]:RLEVEL:OFFset

Front Panel

Access: Amplitude, Reference Level

:DISPlay:WINDow:TRACe:Y[:SCALe]:RLEVel:OFFSet <rel ampl>
:DISPlay:WINDow:TRACe:Y[:SCALe]:RLEVel:OFFSet?

Title: Reference Level Offset

Description: Sets the reference level offset value for the y-axis.

Parameter: <rel ampl>

Default Value: 0 dB

Default Unit: dB

Range: -99.9 dB to 99.9 dB

Front Panel

Access: Amplitude, RL Offset

:DISPlay[:WINDow]:TRACe:Y[:SCALe]:RLEVel:AUTO IMMEDIATE

Title: Automatic Reference Level

Description: Causes the reference level to immediately be set to an automatically computed value that best displays the particular data. The computed reference level is the smallest multiple of the scale that would cause the current trace peak to be positioned half a division from the top grid line. This command is semantically equivalent to
:DISPlay[:WINDow]:TRACe[:SCALe]:RLEVel <amplitude> with
the computed value for amplitude.

Parameter: IMMEDIATE

Front Panel

Access: Shift-8 (System), Application Options, Auto Ref Level

5-5 :FETCh Subsystem

This set of commands returns the most recent measurement data of the active measurement. They will not switch to another measurement.

To make a new measurement, use the INITiate command. To get new measurement data, use the READ or MEASure query commands.

:FETCh:ACPower?

Title: Fetch Adjacent Channel Power Ratio

Description: Returns the most recent adjacent channel power ratio measurement results. If the instrument is sweeping, it will not return until the sweep is complete. If the instrument is not sweeping and the current data is not valid it will return error -230. This could occur if there was a *RST immediately before the :FETCh? or if a measurement parameter was changed without an :INITiate.

Data is returned as 5 comma-separated values: main channel power, lower adjacent channel power, upper adjacent channel power, lower alternate channel power, upper alternate channel power.

Default Unit: Current amplitude units

:FETCh:CHPower:CHPower?

Title: Fetch Channel Power

Description: Returns the most recent channel power measurement result. It returns only the channel power, not the channel power density. Use :FETCh:CHPower? to get both channel power and channel power density.

Default Unit: Current amplitude units

Related Command: :FETCh:CHPower?
:FETCh:CHPower:DENSity?

:FETCh:CHPower:DENSity?

Title: Fetch Channel Power Density

Description: Returns the most recent channel power density measurement result. It returns only the channel power density, not the channel power. Use :FETCh:CHPower? to get both channel power and channel power density. If the instrument is sweeping, it will not return until the sweep is complete. If the instrument is not sweeping and the current data is not valid it will return error -230. This could occur if there was a *RST immediately before the :FETCh? or if a measurement parameter was changed without an :INITiate.

Default Unit: Current amplitude units

:FETCh:CHPower?

Title: Fetch Channel Power/Density

Description: This command returns the most recent channel power measurement results: channel power and channel power density. If the instrument is sweeping, it will not return until the sweep is complete. If the instrument is not sweeping and the current data is not valid it will return error -230. This could occur if there was a *RST immediately before the :FETCh? or if a measurement parameter was changed without an :INITiate.

Data is returned as 2 comma-separated values: channel power, channel power density.

Default Unit: Current amplitude units

Related Command: :FETCh:CHPower:CHPower?
:FETCh:CHPower:DENSity?

:FETCh:OBWidth:FREQuency?

Title: Fetch Occupied Bandwidth Frequency

Description: Returns the most recent occupied bandwidth lower frequency and upper frequency.

Data is returned as 2 comma-separated values: lower frequency and upper frequency in Hz.

Default Unit: Hz

Related Command: :FETCh:CHPower?
:FETCh:CHPower:CHPower?

:FETCh:OBWidth?

Title: Fetch Occupied Bandwidth

Description: Returns the most recent occupied bandwidth measurement results: occupied bandwidth, percent of power and dB down. One of either percent of power or dB down is measured and the other is set. That is determined by the value set using [:SENSE]:OBWidth:METHod. If the instrument is sweeping, it will not return until the sweep is complete. If the instrument is not sweeping and the current data is not valid it will return error -230. This could occur if there was a *RST immediately before the :FETCh? or if a measurement parameter was changed without an :INITiate.

Data is returned as 3 comma-separated values: occupied bandwidth, percent of power, dB down.

Default Unit: OBW in Hz, Percent of Power in %, dB Down in dB

5-6 :FORMat Subsystem

This subsystem contains commands that determine the formatting of numeric data when it is transferred.

The format setting affects data in specific commands only. If a command is affected, it is noted in the command description.

```
:FORMat[:READings][:DATA] ASCii|INTeger,32|REAL,[<length>]  
:FORMat[:READings][:DATA]?
```

Title: Numeric Data Format

Description: This command specifies the format in which data is returned in certain commands. The optional <length> parameter is needed for REAL format only. It defines the length of the floating point number in bits. Valid values are 32 and 64. If no length is specified, the default length of REAL data is set to 64 bits.

ASCii format returns the data in comma-separated ASCII format. The units are the current instrument units. This format requires many more bytes so it is the slowest format. INTeger, 32 values are signed 32-bit integers in little-endian byte order. This format returns the data in 4-byte blocks. The units are always mdBm. For example, if the measured result was -12.345 dBm, that value would be sent as -12345. REAL,32 values are 32-bit floating point numbers conforming to the IEEE 754 standard in little-endian byte order. This format returns the data in 4-byte binary format. The units are the current instrument units. REAL,64 values are 64-bit floating point numbers conforming to the IEEE 754 standard in little-endian byte order. This format returns the data in 8-byte binary format. The units are the current instrument units. For a more precise reading, REAL,64 should be used instead of REAL,32 when the current instrument unit is set to Volt or Watt.

Both INTeger and REAL formats return a definite block length. Each transfer begins with an ASCII header such as #42204 for INTeger,32 and REAL,32 and #44408 for REAL,64. The first digit represents the number of following digits in the header (in this example, 4). The remainder of the header indicates the number of bytes that follow the header (in this example, 2204 for INT,32 and REAL,32 and 4408 for REAL,64). You then divide the number of following bytes by the number of bytes in the data format you've chosen (4 for both INTeger,32 and REAL,32, and 8 for REAL,64) to get the number of data points (in this example, 551).

Parameter: ASCii|INTeger,32|REAL,[<length>]

Parameter Type: <char>

Default Value: ASCii

Related Command: :TRACe[:DATA]

5-7 :INITiate Subsystem

This subsystem controls the triggering of measurements.

:INITiate:CONTInuous OFF|ON|0|1

:INITiate:CONTInuous?

Title: Continuous/Single Sweep

Description: Specifies whether the sweep/measurement is triggered continuously. If the value is set to ON or 1, another sweep/measurement is triggered as soon as the current one completes. If continuous is set to OFF or 0, the instrument enters the “idle” state and waits for the :INITiate[:IMMediate] command or for :INITiate:CONTInuous ON. The default value is ON. That is, sending :INIT:CONT is equivalent to sending :INIT:CONT ON. The query version of the command returns a 1 if the instrument is continuously sweeping/measuring and returns a 0 if the instrument is in single sweep/measurement mode. Note that rapid toggling between ON and OFF is not allowed. The instrument must be allowed to make a full sweep before toggling can be done.

Parameter: OFF|ON|0|1

Parameter Type: <boolean>

Default Value: ON

Related Command: :INITiate[:IMMediate]
:INITiate:HOLD

Front Panel

Access: Shift-3 (Sweep), Sweep

:INITiate[:IMMediate]

Title: Trigger Sweep/Measurement

Description: Initiates a sweep/measurement. If :INITiate:CONTInuous is set to ON, this command is ignored. Use this command in combination with :STATus:OPERation? to synchronize the capture of one complete set of data. When this command is sent, the “sweep complete” bit of :STATus:OPERation? is set to 0, indicating that the measurement has not completed. The data collection is then triggered. The controlling program can poll :STATus:OPERation? to determine the status. When the “sweep complete” bit is set to 1, data is ready to be retrieved.

When averaging is on, the sweep complete bit is set after the first sweep is completed. An :INITiate[:IMMediate] command must be issued for each additional sweep desired.

Related Command: :INITiate:CONTInuous
:STATus:OPERation?

Front Panel

Access: Shift-3 (Sweep), Sweep Once

:INITiate:SAVe:ON:EVENT:CROSSing:LIMit OFF|ON|0|1

Title: Save On Crossing Limit

Description: When set to ON, automatically saves measurement data when the trace crosses a specified limit line. A limit line must be defined before this command can be enabled.

Default Value: OFF

Related Command: :CALCulate:LIMit
:MMEMory:STORe:TRACe

Front Panel Access: **Shift-7 (File)**, Save On Event, ...Crossing Limit

:INITiate:SAVe:ON:EVENT:SWEep OFF|ON|0|1

Title: Save On Sweep Complete

Description: When set to ON, measurement data is automatically saved after each sweep is completed.

Default Value: OFF

Related Command: :MMEMory:STORe:TRACe

Front Panel Access: **Shift-7 (File)**, Save On Event, ...Sweep Complete

:INITiate:SAVe:THEN:STOp OFF|ON|0|1

Title: Save Then Stop

Description: When set to ON, stops the sweep after a measurement is saved. If this setting is Off and Sweep Complete is On, a measurement is saved after every sweep.

Default Value: OFF

Related Command: :MMEMory:STORe:TRACe

Front Panel Access: **Shift-7 (File)**, Save On Event, Save Then Stop

5-8 :MEASure Subsystem

These commands take the instrument from its current state, enable the specified measurement and put the instrument into single sweep mode. They correct any parameters that are invalid given the new measurement state such that a valid measurement can take place. Other settings may be changed; see the documentation of CONFigure for each measurement. They then initiate the measurement. When the measurement is complete, they return the result.

To make a measurement with settings other than the “default” measurement settings applied by CONFigure, do the following:

- Send the appropriate CONFigure command to set the desired measurement.
- Modify the settings as required.
- Send the appropriate READ command to measure and return the result.

To get the current measurement data, use the appropriate FETCh command.

:MEASure:ACPower?

Title: Measure Adjacent Channel Power Ratio

Description: Sets the active measurement to adjacent channel power ratio, sets the default measurement parameters, triggers a new measurement and returns the main channel power lower adjacent and upper adjacent channel power results. It is a combination of the commands :CONFigure:ACPower and :READ:ACPower? For a description of the default adjacent channel power ratio measurement parameters, see :CONFigure:ACPower. To make an adjacent channel power ratio measurement with settings other than the default values, send:

:CONFigure:ACPower

Commands to set desired settings

:READ:ACPower?

Data is returned as 5 comma-separated values: main channel power, lower adjacent channel power, upper adjacent channel power, lower alternate channel power, upper alternate channel power.

Default Unit: Current amplitude units

Related Command: :CONFigure:ACPower

:MEASure:CHPower:CHPower?

Title: Measure Channel Power

Description: Sets the active measurement to channel power, sets the default measurement parameters, triggers a new measurement and returns the channel power result. To measure both channel power and channel power density use :MEASure:CHPower? It is a combination of the commands :CONFigure:CHPower and :READ:CHPower:CHPower? For a description of the default channel power measurement parameters, see :CONFigure:CHPower. To make a channel power measurement with settings other than the default values, send:

:CONFigure:CHPower
 Commands to set desired settings
 :READ:CHPower:CHPower?

Default Unit: Current amplitude units

Related Command: :MEASure:CHPower?
 :MEASure:CHPower:DENSity?
 :CONFigure:CHPower

:MEASure:CHPower:DENSity?

Title: Measure Channel Power Density

Description: Sets the active measurement to channel power, sets the default measurement parameters, triggers a new measurement and returns the channel power density result. To measure both channel power and channel power density use :MEASure:CHPower? It is a combination of the commands :CONFigure:CHPower and :READ:CHPower:DENSity? For a description of the default channel power measurement parameters, see :CONFigure:CHPower. To make a channel power measurement with settings other than the default values, send:

:CONFigure:CHPower
 Commands to set desired settings
 :READ:CHPower:DENSity?

Default Unit: Current amplitude units

Related Command: :MEASure:CHPower?
 :MEASure:CHPower:CHPower?
 :CONFigure:CHPower

:MEASure:CHPower?

Title: Measure Channel Power/Density

Description: Sets the active measurement to channel power, sets the default measurement parameters, triggers a new measurement and returns the channel power and channel power density results. It is a combination of the commands :CONFigure:CHPower and :READ:CHPower? For a description of the default channel power measurement parameters, see :CONFigure:CHPower. To make a channel power measurement with settings other than the default values, send:

:CONFigure:CHPower
 Commands to set desired settings
 :READ:CHPower?

Data is returned as 2 comma-separated values: channel power, channel power density.

Default Unit: Current amplitude units

Related Command: :MEASure:CHPower:CHPower?
 :MEASure:CHPower:DENSity?
 :CONFigure:CHPower

:MEASure:OBWidth?

Title: Measure Occupied Bandwidth

Description: Sets the active measurement to occupied bandwidth, sets the default measurement parameters, triggers a new measurement and returns the occupied bandwidth, percent of power and dB down results. It is a combination of the commands :CONFigure:OBWidth and :READ:OBWidth? For a description of the default occupied bandwidth measurement parameters, see :CONFigure:OBWidth. To make an occupied bandwidth measurement with settings other than the default values, send:

:CONFigure:OBWidth

Commands to set desired settings

:READ:OBWidth?

Data is returned as 3 comma-separated values: occupied bandwidth, percent of power, dB down.

Default Unit: For OBW: Hz
For Percent of Power:N%
For dB Down:NdB

Related Command: :CONFigure:OBWidth
:CONFigure:RF SPECTrum

5-9 :MMEMory Subsystem

The Mass Memory subsystem contains functions that provide access to the instrument's setup and data storage.

:MMEMory:DATA? <filename>

Title: Transfer Data

Description: Transfers the data stored in the given file from the instrument to the controlling program. Data is transferred in the form of <header><block>. The ASCII <header> specifies the number of data bytes. It looks like #AX, where A is the number of digits in X and X is the number of bytes in <block>. <filename> should be enclosed in either single quotes (') or double quotes (") and should contain a file extension (e.g., .stp, .jpg) and the file must not be larger than 262136 bytes. Use the command MMEMory:MSIS to set the current save location.

Parameter: <filename>

:MMEMory:DELeTe <filename>

Title: Delete Setup/Measurement

Description: Removes a file specified by <filename> from the current mass storage device. <filename> should be enclosed in either single quotes (') or double quotes (") and it must include the file extension. Use the command MMEMory:MSIS to set the current file location.

Parameter: <filename>

Related Command: :MMEMory:STORE:STATe
:MMEMory:STORE:TRACe
:MMEMory:MSIS INTernal|USB

Front Panel

Access: Shift-7 (File), Delete, Delete Selected File

:MMEMory:LOAD:LIMit <filename>

Title: Recall Limit

Description: Recalls a previously stored limit from the current save location. The saved limit setting to be loaded is specified by <filename>. <filename> should be enclosed in either single quotes (') or double quotes (") and should contain a file extension ".lim". Note that the trace specified by <filename> should be available at the current save location. Use the command MMEMory:MSIS to set the current save location. File Extension: ".lim"

Parameter: <filename>

Example: To recall trace with file name "limit"
:MMEMory:LOAD:LIMit "limit.lim"

Related Command: :MMEMory:STORe:LIMit

Front Panel

Access: Shift-7 (File), Recall

:MMEMory:LOAD:STATe <integer>,<filename>

Title: Recall Setup

Description: Recalls a previously stored instrument setup in the current save location. The setup file to be loaded is specified by <filename>. <filename> should be enclosed in either single quotes (') or double quotes (" ") and should contain a file extension ".stp". Use the command MMEMory:MSIS to set the current save location. The <integer> parameter is not currently used, but it must be sent. Send a 1.

Parameter: <integer>, <filename>

Related Command: :MMEMory:STORe:STATe
:MMEMory:MSIS INTernal|USB

Front Panel

Access: Shift-7 (File), Recall

:MMEMory:LOAD:TRACe <integer>,<filename>

Note This command requires front panel access to select the trace and to complete the command.

Title: Recall Measurement

Description: The instrument must be in the mode of the saved trace in order to recall that trace. Use :INSTRument:SElect or :INSTRument:NSElect to set the mode. Recalls a previously stored measurement trace from the current save location. The saved measurement trace to be loaded is specified by <filename>. <filename> should be enclosed in either single quotes (') or double quotes (" ") and should contain a file extension. Note that the trace specified by <filename> should be available at the current save location. Use the command MMEMory:MSIS to set the current save location. The <integer> parameter is not currently used, but it must be sent. Send a 1.

File name extensions:

- “.edg” for GSM
- “.spa” for SPA
- “.wcd” for WCDMA
- “.wmx” for WiMAX
- “.wmx” for Mobile WiMAX
- “.vna” for Cable & Antenna
- “.cdma” for CDMA
- “.tds” for TDSCDMA
- “.evdo” for EVDO
- “.ia” for Interference Analysis
- “.cs” for Channel Scanner
- “.pm” for Power Meter
- “.tm” for Transmission Measurement
- “.lte” for LTE Analyzer

Note: Extensions not available for T1 and Hi_PM.

Parameter: <integer>, <filename>

Example: To recall trace with file name “trace”:

```
:MMEMory:LOAD:TRACe 1, "trace.spa"
```

Related Command: :MMEMory:STORe:TRACe
:MMEMory:MSIS INTernal|USB

Front Panel

Access: Shift-7 (File), Recall Measurement

:MMEMory:STORe:LIMit <filename>

Title: Save Limit

Description: Stores the current limit setup into the file specified by <filename>. <filename> should be enclosed in either single quotes (') or double quotes (") and should not contain a file extension. Use the command MMEMory:MSIS to set the current save location.

Parameter: <filename>

Related Command: :MMEMory:MSIS INTernal|USB

Front Panel

Access: Shift-7 (File), Save

:MMEMory:STORe:STATe <integer>,<filename>

Title: Save Setup

Description: Stores the current setup into the file specified by <filename>. <filename> should be enclosed in either single quotes (') or double quotes (") and should not contain a file extension. Use the command MMEMory:MSIS to set the current save location. The <integer> parameter is not currently used, but it must be sent. Send a value of 0.

Parameter: <integer>, <filename>

Related Command: :MMEMory:LOAD:STATe
:MMEMory:MSIS INTernal|USB

Front Panel

Access: Shift-7 (File)

:MMEMory:STORe:TRACe <integer>,<filename>

Title: Save Measurement

Description: Stores the trace into the file specified by <filename>. <filename> should be enclosed in either single quotes (') or double quotes (") and should not contain a file extension. Use the command MMEMory:MSIS to set the current save location. The <integer> parameter is not currently used, but it must be sent. Send a 0. Note that existing files of the same name will not be overwritten.

Parameter: <integer>, <filename>

Example: To save the trace into the file name "trace":

```
:MMEMory:STORe:TRACe 0,"trace"
```

Related Command: :MMEMory:LOAD:TRACe
:MMEMory:MSIS INTernal|USB

Front Panel

Access: Shift-7 (File), Save

5-10 :READ Subsystem

This set of commands combines the ABORT, INITiate and FETCh commands. It aborts any current triggering sequence and sets the trigger state to idle. It then initiates a new active measurement (i.e. begins the collection of new data). When the measurement is complete, it returns the result. These commands will not switch to another measurement.

To get the current measurement data, use the FETCh command.

:READ:ACPower?

Title: Read Adjacent Channel Power Ratio

Description: Triggers a new adjacent channel power ratio measurement and returns the results: main channel power, lower adjacent and upper adjacent channel power. It is a combination of the commands :ABORT; :INITiate; :FETCh:ACPower? The channel power measurement must be the active measurement (specified by the command :CONFigure:ACPower). The current measurement can be queried using the command :CONFigure?

Data is returned as 5 comma-separated values: main channel power, lower adjacent channel power, upper adjacent channel power, lower alternate channel power, upper alternate channel power.

Related Command: :READ:ACPower?
:CONFigure

:READ:CHPower:DENSity?

Title: Read Channel Power Density

Description: Triggers a new channel power measurement and returns the channel power density result. It is a combination of the commands :ABORT; :INITiate; :FETCh:CHPower:DENSity? It returns only the channel power density, not the channel power. Use the command :READ:CHPower? to get both channel power and channel power density. The channel power measurement must be the active measurement (specified by :CONFigure:CHPower). The current measurement can be queried using :CONFigure? command.

Default Unit: Current amplitude units

Related Command: :READ:CHPower?
:READ:CHPower:CHPower?
:CONFigure

:READ:CHPower?

Title: Read Channel Power/Density

Description: Triggers a new channel power measurement and returns the results: channel power and channel power density. It is a combination of the commands :ABORT; :INITiate; :FETCh:CHPower? The channel power measurement must be the active measurement (specified by the command :CONFigure:CHPower). The current measurement can be queried using the command :CONFigure?

Data is returned as 2 comma-separated values: channel power, channel power density.

Default Unit: dBm

Related Command: :READ:CHPower:CHPower?
:READ:CHPower:DENSity?
:CONFigure

:READ:OBWidth?

Title: Read Occupied Bandwidth

Description: Triggers a new occupied bandwidth measurement and returns the results: occupied bandwidth, percent of power and dB down. It is a combination of the commands :ABORT; :INITiate; :FETCh:OBWidth? The occupied bandwidth measurement must be the active measurement (specified by :CONFigure:OBWidth). The current measurement can be queried using the :CONFigure?

ata is returned as 3 comma-separated values: occupied bandwidth, percent of power, dB down.

Default Unit: For OBW:NHz
For Percent of Power:N%
For dB Down:NdB

Related Command: :CONFigure

5-11 :TRACe Subsystem

This subsystem contains commands related to the transfer of trace data to and from the instrument.

:TRACe:COPIY TRACE1,TRACE2|TRACE3

Title: Trace Copy

Description: Copies Trace A to either Trace B or Trace C. Copying Trace A to Trace B is equivalent to pressing the Shift-5 (Trace), Trace B Operations, A->B on the front panel. This store Trace A into Trace B and turns on Trace B if it was off. Copying Trace A to Trace C is equivalent to pressing the Shift-5 (Trace), Trace C Operations, A->C on the front panel. This store Trace A into Trace C and turns on Trace C if it was off.

Parameter: TRACE1,TRACE2|TRACE3

Parameter Type: <char>

Example: To copy Trace A to Trace B:

```
:TRACe:COPIY TRACE1,TRACE2
```

To copy Trace A to Trace C:

```
:TRACe:COPIY TRACE1,Trace3
```

:TRACe:EXCHange TRACE2,TRACE3

Title: Trace Exchange

Description: Swaps Trace B and Trace C.

Parameter: TRACE2,TRACE3

Parameter Type: <char>

Front Panel

Access: Shift-5 (Trace), Trace B Operations, B<->C

Shift-5 (Trace), Trace C Operations, B<->C

:TRACe:PREamble? {1|2|3}

Title: Trace Header Transfer

Description: Returns trace header information for the specified trace. Data can be transferred to and from the 3 available display traces. Use the commands in the MMEMory subsystem to store and recall traces from the instrument memory. The response begins with an ASCII header. The header specifies the number of following bytes. It looks like #AX, where A is the number of digits in X and X is the number of bytes that follow the header. Parameters are returned in comma-delimited ASCII format. Each parameter is returned as "NAME=VALUE[UNITS]," Note that the parameters returns depend on the firmware version and that this document does not cover all parameter values returned by the command. Valid parameter names are shown in "[Spectrum Analyzer Parameter Names](#)" on page 2-13.

Parameter: [1]|2|3

Range: 1|2|3

:TRACe[:DATA] {1|2|3}, (<header><block>)**:TRACe[:DATA]? {1|2|3}**

Title: Trace Data Transfer

Description: This command transfers data from the controlling program to the instrument. The query form transfers trace data from the instrument to the controller. Data is transferred to the instrument enclosed in parentheses as (<header><block>) and from the instrument as <header><block>.

The ASCII header specifies the number of data bytes. It looks like #AX, where A is the number of digits in X and X is the number of bytes in the <block>.

The format of the block data in the query form is specified by :FORMat:DATA. The block data in the command form is always sent in ASCII format. Data can be transferred to and from the 3 available display traces. Use the commands in the MMEMory subsystem to store and recall traces from the instrument memory. The command form does not support setting all trace points to a single value. To do this, send the same value to each point. Trace setup information can be acquired using :TRACe[:DATA]:PREamble?.

To acquire the data from trace A in the instrument, send :TRACe:DATA? 1. A 551 point trace is returned as #42204<block data>. <block> data could be in either INTeger,32 or REAL,32 format. In both cases, there is 4 bytes per data point. So, 4 bytes per point * 551 data points gives 2204 bytes in <block> data. This example assumes that :FORMat:DATA INTeger,32 or :FORMat:DATA REAL,32 has been sent to the instrument before the query command is sent.

The query command will return a #0 if data is invalid for the active trace.

Parameter: {1|2|3},(<header><block>)

Related Command: :FORMat:DATA
:TRACe[:DATA]:PREamble?

:TRACe{1|2|3}:DISPlay[:STATe] OFF|ON|0|1

:TRACe{1|2|3}:DISPlay[:STATe]?

Title: Trace View State

Description: Specifies whether the specified trace should be displayable (visible) or hidden. TRACe1 corresponds to Trace A, TRACe2 corresponds to Trace B, and TRACe3 corresponds to Trace C. Setting the value to ON or 1 will set the specified trace visible. Setting the value to OFF or 0 will set the specified trace hidden. Note that issuing this command will also set the specified trace as active trace.

Parameter: OFF|ON|0|1

Parameter Type: <boolean>

Default Value: ON for Trace A
OFF for Trace B
OFF for Trace C

Example: To set Trace A to Blank:

```
:TRACe:DISPlay OFF
:TRACe1:DISPlay 0
```

To set Trace B to View:

```
:TRACe2:DISPlay ON
:TRACe2:DISPlay:STATe ON
:TRACe2:DISPlay 1
```

Front Panel

Access: Shift-5 (Trace), View/Blank

:TRACe{1|2|3}:LOAD:DISPlay[:STATe] OFF|ON|0|1

:TRACe{1|2|3}:LOAD:DISPlay[:STATe]?

Title: Trace View State

Description: Specifies whether the specified recall trace should be displayable (visible) or hidden. TRACe1 corresponds to Trace A, TRACe2 corresponds to Trace B, and TRACe3 corresponds to Trace C. Setting the value to ON or 1 will set the specified trace visible. Setting the value to OFF or 0 will set the specified trace hidden. Note that this command is valid only if there is a trace recalled.

Parameter: OFF|ON|0|1

Parameter Type: <boolean>

Default Value: OFF

Example: To set Trace A to Blank:

```
:TRACe:LOAD:DISPlay OFF
:TRACe1:LOAD:DISPlay 0
```

To set Trace B to View:

```
:TRACe2:LOAD:DISPlay ON
:TRACe2:LOAD:DISPlay:STATe ON
:TRACe2:LOAD:DISPlay 1
```

Front Panel

Access: Shift-5, Trace [A/B/C], View Blank

Note

These SCPI commands are applicable only if the user selects the option to recall the trace to Trace A and not show the live trace.

:TRACe{1|2|3}:WRITe[:STATe] OFF|ON|0|1

:TRACe{1|2|3}:WRITe[:STATe]?

Title: Trace Write State

Description: Specifies whether the specified trace state should be set to write or hold. TRACe1 corresponds to Trace A, TRACe2 corresponds to Trace B, and TRACe3 corresponds to Trace C. Setting the state to ON or 1 will set the specified trace to write. Setting the state to OFF or 0 will set the specified trace to hold.

Parameter: OFF|ON|0|1

Parameter Type: <boolean>

Default Value: ON for Trace A
OFF for Trace B
OFF for Trace C

Example: To set Trace A to Hold:

```
:TRACe:WRITe:STATe OFF
:TRACe:WRITe OFF OR :TRACe:WRITe 0
```

To set Trace C to Write:

```
:TRACe3:WRITE ON
:TRACe3:WRITE:STATE ON
:TRACe3:WRITE 1
```

Related Command: :TRACe:DATA

Front Panel

Access: Shift-5 (Trace), Write/Hold

:TRACe1:OPERation NORMAl|MAXHold|MINHold|AVERage
:TRACe1:OPERation?

Title: Trace A Operation

Description: This command specifies how successive traces are combined to produce the resulting display values.

Setting the operation to NORMAl is equivalent to pressing the Shift-5 (Trace), Trace A Operations, Normal->A on the front panel. This displays a trace based on the detection method selected.

Setting the operation to MAXHold is equivalent to pressing the Shift-5 (Trace), Trace A Operations, Max Hold->A on the front panel. This displays the largest signal for each display point over multiple sweeps.

Setting the operation to MINHold is equivalent to pressing the Shift-5 (Trace), Trace A Operations, Min Hold->A on the front panel. This displays the smallest signal for each display point over multiple sweeps.

Setting the operation to AVERage is equivalent to pressing the Shift-5 (Trace), Trace A Operations, Average->A on the front panel. This displays the average value of multiple sweeps for each display point.

The query version of the command returns the current operation mode or "NONE" if no operation is set.

Parameter: NORMAl|MAXHold|MINHold|AVERage

Parameter Type: <char>

Default Value: NORMAl

Related Command: [:SENSe]:AVERage:TYPE

:TRACe2:OPERation MAXHold|MINHold
:TRACe2:OPERation?

Title: Trace B Operation

Description: This command specifies how successive traces are combined to produce the resulting display values.

Setting the operation to MAXHold is equivalent to pressing the Shift-5 (Trace), Trace B Operations, Max Hold->B on the front panel. This displays the largest signal for each display point over multiple sweeps.

Setting the operation to MINHold is equivalent to pressing the Shift-5 (Trace), Trace B Operations, Min Hold->B on the front panel. This displays the smallest signal for each display point over multiple sweeps.

The query version of the command returns the current operation mode or "NONE" if no operation is set.

Parameter: MAXHold | MINHold

Parameter Type: <char>

Default Value: None

Range: MAXHold | MINHold

:TRACe3:OPERation MAXHold|MINHold|A-B|B-A

:TRACe3:OPERation?

Title: Trace C Operation

Description: This command specifies how successive traces are combined to produce the resulting display values.

Setting the operation to MAXHold is equivalent to pressing the Shift-5 (Trace), Trace C Operations, Max Hold->C on the front panel. This displays the largest signal for each display point over multiple sweeps.

Setting the operation to MINHold is equivalent to pressing the Shift-5 (Trace), Trace C Operations, Min Hold->C on the front panel. This displays the smallest signal for each display point over multiple sweeps.

Setting the operation to A-B is equivalent to pressing the Shift-5 (Trace), Trace C Operations, A-B->C. This displays the difference between trace A and trace B values in trace C.

Setting the operation to B-A is equivalent to pressing the Shift-5 (Trace), Trace C Operations, B-A->C. This displays the difference between trace B and trace A values in trace C.

The query version of the command returns the current operation mode or "NONE" if no operation is set.

Parameter: MAXHold | MINHold | A-B | B-A

Parameter Type: <char>

Default Value: None

Range: MAXHold | MINHold | A-B | B-A

5-12 :TRIGger Subsystem

This subsystem contains commands related to the triggering of instrument functions for the purposes of synchronization. Related commands appear in the ABORT and INITiate subsystems.

:TRIGger[:SEquence]:SOURce IMMEDIATE|EXTERNAL|VIDEO
:TRIGger[:SEquence]:SOURce?

Title: Trigger Source

Description: This command defines the trigger source. IMMEDIATE triggering is the equivalent of free-run triggering. EXTERNAL triggering is triggered when a TTL signal is applied to the External Trigger input connector. EXTERNAL triggering is always done on the rising edge of the signal. It is available only in zero span mode.

Parameter: IMMEDIATE | EXTERNAL | VIDEO

Parameter Type: <char>

Default Value: Immediate

Range: IMMEDIATE | EXTERNAL | VIDEO

Related Command: :TRIGger[:SEquence]:VIDEO:LEVEL
 :TRIGger[:SEquence]:VIDEO:DELAY

Front Panel

Access: Shift-3 (Sweep), Triggering, Source

:TRIGger[:SEquence]:VIDEO:LEVEL <amplitude>
:TRIGger[:SEquence]:VIDEO:LEVEL?

Title: Video Trigger Level

Description: This command sets the video triggering level.

Parameter: <amplitude>

Default Value: -65.0 dBm

Default Unit: Current amplitude unit

Range: 30 dBm to -150 dBm

Related Command: :TRIGger[:SEquence]:SOURce

Front Panel

Access: Shift-3 (Sweep), Triggering, Level

:TRIGger[:SEQuence]:VIDeo:DELAy <percentage> or <time>
:TRIGger[:SEQuence]:VIDeo:DELAy?

Title: Video Trigger Position (Time)

Description: This command sets the video triggering delay as either a percentage of the display or in time units. If setting the delay by time is desired, then time units must be specified when sending the command. The query version of this command returns the video triggering delay as a percentage.

Parameter: <percentage> or <time>

Default Value: -1

Default Unit: %

Range: -100% to +200% (-1 ms to +2 ms)

Example: To set the delay to 1 ms:

```
:TRIGger:SEQuence:VIDeo:DELAy 1 ms
```

To set the delay to 1%:

```
:TRIGger:SEQuence:VIDeo:DELAy 1
```

Front Panel

Access: Shift-3 (Sweep), Triggering, Delay

5-13 :UNIT Subsystem

The unit subsystem is used to modify the default units used for related parameters. These changes affect parameters in both commands and responses.

:UNIT:POWer DBM|DBV|DBMV|DBUV|V|W|DBW|A|DBA|WCM2

:UNIT:POWer?

Title: Measurement Units

Description: Sets the default amplitude units for input, output and display.

Available units: dBm, dBV, dBmV, dBuV, Volt, Watt, dBW, A, dBA, Wcm2

Note that linear units are not operational with SPA V3.06. The set command is non-operational with SPA V3.06 as well.

Note that Wcm2 is available only in Field Strength measurement. Units dBW, A, dBA, Wcm2 are not operational with SPA V5.70 and below.

Parameter: DBM|DBV|DBMV|DBUV|V|W|DBW|A|DBA|WCM2

Parameter Type: <char>

Default Value: dBm

Front Panel

Access: Amplitude, Units, (More)

5-14 [:SENSE] Subsystem

The commands in this subsystem relate to device-specific parameters, not signal-oriented parameters.

[:SENSE]:ACPower:BANDwidth|BWIDth:ADJacent <freq>

[:SENSE]:ACPower:BANDwidth|BWIDth:ADJacent?

Title: ACPR Adjacent Channel Bandwidth

Description: Sets the adjacent channel bandwidth for the ACPR measurement.

Parameter: <freq>

Default Value: 10.35 MHz

Default Unit: Hz

Front Panel

Access: Shift-4 (Measure), Power and Bandwidth, ACPR, Adj/Alt Ch BW

[:SENSE]:ACPower:BANDwidth|BWIDth:MAIN <freq>

[:SENSE]:ACPower:BANDwidth|BWIDth:MAIN?

Title: ACPR Main Channel Bandwidth

Description: Sets the main channel bandwidth for the ACPR measurement.

Parameter: <freq>

Default Value: 10.35 MHz

Default Unit: Hz

Front Panel

Access: Shift-4 (Measure), Power and Bandwidth, ACPR, Main Ch BW

[:SENSE]:ACPower:BANDwidth|BWIDth:SPACing <freq>

[:SENSE]:ACPower:BANDwidth|BWIDth:SPACing?

Title: ACPR Channel Spacing

Description: Sets the channel spacing for the ACPR measurement.

Parameter: <freq>

Default Value: 10.35 MHz

Default Unit: Hz

Front Panel

Access: Shift-4 (Measure), Power and Bandwidth, ACPR, Ch Spacing

[:SENSe]:ACPower:STATE OFF|ON|0|1

[:SENSe]:ACPower:STATE?

Title: ACPR Measurement State

Description: Sets the state of the adjacent channel power ratio measurement, ON or OFF. When using :CONFigure:ACPower, the state is automatically set to ON.

Parameter: OFF|ON|0|1

Parameter Type: <boolean>

Default Value: OFF

[:SENSe]:AVERage:COUNT <integer>

[:SENSe]:AVERage:COUNT?

Title: Number of Traces to Average

Description: Sets the number of traces to average.

Parameter: <integer>

Parameter Type: <integer>

Default Value: 10

Range: 2 to 65535

Front Panel

Access: Shift-5 (Trace), Trace A Operations, # of Averages

[:SENSE]:AVERAGE:TYPE NONE | SCALAR | MAXIMUM | MINIMUM

[:SENSE]:AVERAGE:TYPE?

Title: Trace Mode (Normal/Average/Max Hold/Min Hold)

Description: Specifies how successive traces are combined to produce the resulting display value. Setting the TYPE to NONE is the equivalent of setting the trace mode to “Normal->A” on the front panel. The displayed value for a point is the current measured value for that point. Setting the TYPE to SCALAR is the equivalent of setting the trace mode to “Average->A” on the front panel. The displayed value for a point is the average of the last <integer> measured values where <integer> is set by [:SENSE]:AVERAGE:COUNT. Setting the TYPE to MAXIMUM is the equivalent of setting the trace mode to “Max Hold->A” on the front panel. The displayed value for a point is the maximum measured value for that point over sweeps. Setting the TYPE to MINIMUM is the equivalent of setting the trace mode to “Min Hold->A” on the front panel. The displayed value for a point is the minimum measured value for that point over sweeps.

Parameter: NONE | SCALAR | MAXIMUM | MINIMUM

Parameter Type: <char>

Default Value: NONE

Example: To set the TYPE to SCALAR:

```
:SENSE:AVERAGE:TYPE SCALAR
```

To set the TYPE to MAXIMUM:

```
:SENSE:AVERAGE:TYPE MAXIMUM
```

Related Command: [:SENSE]:AVERAGE:COUNT

Front Panel

Access: Shift-5 (Trace), Trace A Operations

[:SENSE]:BANDWIDTH|BWIDTh:VIDEo <freq>

[:SENSE]:BANDWIDTH|BWIDTh:VIDEo?

Title: Video Bandwidth

Description: Sets the video bandwidth. Note that using this command turns the automatic video bandwidth setting OFF.

Parameter: <freq>

Default Value: 1 MHz

Default Unit: Hz

Range: 1 Hz to 3 MHz in a 1:3 sequence except for the MS2711E
10 Hz to 3 MHz in a 1:3 sequence for the MS2711E

Related Command: [:SENSE]:BANDWIDTH|BWIDTh:VIDEo:AUTO

Front Panel

Access: BW, VBW

[:SENSe]:BANDwidth|BWIDth:VIDeo:AUTO OFF|ON|0|1

[:SENSe]:BANDwidth|BWIDth:VIDeo:AUTO?

Title: Video Bandwidth Coupling

Description: Sets the state of the coupling of the video bandwidth to the resolution bandwidth. Setting the value to ON or 1 will result in the video bandwidth being coupled to the resolution bandwidth. That is, when the resolution bandwidth changes, the video bandwidth changes. Setting the value to OFF or 0 will result in the video bandwidth being un-coupled from the resolution bandwidth. That is, changing the resolution bandwidth will not change the video bandwidth. When this command is issued, the video bandwidth setting itself will not change. The default value is ON. That is, sending :SENS:BAND:VID:AUTO is equivalent to sending :SENS:BAND:VID:AUTO ON.

Parameter: OFF|ON|0|1

Parameter Type: <boolean>

Default Value: ON

Front Panel

Access: BW, Auto VBW

[:SENSe]:BANDwidth|BWIDth:VIDeo:RATio <number>

[:SENSe]:BANDwidth|BWIDth:VIDeo:RATio?

Title: Video Bandwidth to Resolution Bandwidth Ratio

Description: Sets the ratio of the video bandwidth to the resolution bandwidth for use when the video to resolution bandwidth coupling is enabled. Note that the front panel interface sets the inverse ratio: the resolution bandwidth to the video bandwidth which is an integer, in other words, if you send 0.35, the display will show 2 not 2.857.

Parameter: <number>

Default Value: 0.33

Range: 0.00001 to 1

Related Command: [:SENSe]:BANDwidth|BWIDth:VIDeo:AUTO

Front Panel

Access: BW, RBW/VBW (note that this is the inverse ratio)

[:SENSe]:BANDwidth|BWIDth[:RESolution] <freq>
[:SENSe]:BANDwidth|BWIDth[:RESolution]?

Title: Resolution Bandwidth

Description: Sets the resolution bandwidth. Note that using this command turns OFF the automatic resolution bandwidth setting.

Parameter: <freq>

Default Value: 3 MHz

Default Unit: Hz

Range: 1 Hz to 3 MHz in a 1:3 sequence except for the MS2711E
100 Hz to 3 MHz in a 1:3 sequence for the MS2711E

Related Command: [:SENSe]:BANDwidth|BWIDth[:RESolution]:AUTO

Front Panel

Access: BW, RBW

[:SENSe]:BANDwidth|BWIDth[:RESolution]:AUTO OFF|ON|0|1
[:SENSe]:BANDwidth|BWIDth[:RESolution]:AUTO?

Title: Resolution Bandwidth Coupling

Description: Sets the state of the coupling of the resolution bandwidth to the frequency span. Setting the value to ON or 1 will result in the resolution bandwidth being coupled to the span. That is, when the span changes, the resolution bandwidth changes. Setting the value to OFF or 0 will result in the resolution bandwidth being un-coupled from the span. That is, changing the span will not change the resolution bandwidth. When this command is issued, the resolution bandwidth setting itself will not change. The default value is ON. That is, sending :SENS:BAND:RES:AUTO is equivalent to sending :SENS:BAND:RES:AUTO ON.

Parameter: OFF|ON|0|1

Parameter Type: <boolean>

Default Value: ON

Related Command: [:SENSe]:BANDwidth|BWIDth[:RESolution]:RATio

Front Panel

Access: BW, Auto RBW

[:SENSe]:BANDwidth|BWIDth[:RESolution]:RATio <number>

[:SENSe]:BANDwidth|BWIDth[:RESolution]:RATio?

Title: Resolution Bandwidth to Span Ratio

Description: Sets the ratio of the resolution bandwidth to the span for use when the resolution bandwidth to span coupling is enabled. Note that the front panel interface sets the inverse ratio: the span to the resolution bandwidth.

Parameter: <number>

Default Value: 0.01

Range: 0.00001 to 1

Related Command: [:SENSe]:BANDwidth|BWIDth[:RESolution]:AUTO

Front Panel

Access: BW, Span/RBW (note that this is the inverse ratio)

[:SENSe]:CHPower:BANDwidth|BWIDth:INTEgration <freq>

[:SENSe]:CHPower:BANDwidth|BWIDth:INTEgration?

Title: Channel Power Integration Bandwidth

Description: Sets the integration bandwidth for the channel power measurement. Integration bandwidth must be less than or equal to the frequency span.

Parameter: <freq>

Default Value: 10.35 MHz

Default Unit: Hz

Related Command: [:SENSe]:FREQuency:SPAN

Front Panel

Access: Shift-4 (Measure), Power and Bandwidth, Channel Power, Ch Pwr Width

[:SENSe]:CHPower:STATE OFF|ON|0|1

[:SENSe]:CHPower:STATE?

Title: Channel Power Measurement State

Description: Sets the state of the channel power measurement, ON or OFF. When using :CONFigure:CHPower, the state is automatically set to ON.

Parameter: OFF|ON|0|1

Parameter Type: <boolean>

Default Value: OFF

Related Command: :CONFigure:ACPower

Front Panel

Access: Shift-4 (Measure), Power and Bandwidth, Channel Power, On/Off

[:SENSE]:CORREction:IMPedance[:INPut]:OFFSet <rel ampl>
[:SENSE]:CORREction:IMPedance[:INPut]:OFFSet?

Title: Other Input Impedance Loss

Description: Sets the value that is used for amplitude correction when the value set by [:SENSE]:CORREction:IMPedance[:INPut]:MAGNitude is something other than 50 or 75. This value is not applied if the impedance is set to either 50 or 75.

Parameter: <rel ampl>

Default Value: 0

Default Unit: dB

Range: 0 dB to 100 dB

Related Command: [:SENSE]:CORREction:IMPedance[:INPut][:MAGNitude]

Front Panel

Access: Shift-8 (System), Application Options, Impedance

[:SENSE]:CORREction:IMPedance[:INPut][:MAGNitude] <integer>
[:SENSE]:CORREction:IMPedance[:INPut][:MAGNitude]?

Title: Input Impedance

Description: Sets the input impedance that is used for amplitude correction and conversion between units (dBm vs. dBV vs. Volts, etc.). If the value of <integer> is 50 no correction is performed. If the value of <integer> is 75 correction is done based on Anritsu adapter 12N50-75B.

Parameter: <integer>

Parameter Type: <integer>

Default Value: 50

Range: 50, 75 all other values are treated as described above

Related Command: [:SENSE]:BANDwidth|BWIDth:VIDeo:RATio

Front Panel

Access: Shift-8 (System), Application Options, Impedance

**[:SENSe]:DETEctor[:FUNction] POSitive|RMS|NEGative|SAMPLE
[:SENSe]:DETEctor[:FUNction]?**

Title: Detection Type

Description: Sets the detection method for calculating each display point. Each display point represents several measurements. The detection type determines how the display point is derived from its associated measurements. POSitive Peak detection displays the maximum value of the associated measurements. RMS detection displays the average power of the associated measurements. NEGative Peak detection displays the minimum value of the associated measurements. SAMPlE detection displays the “middle” point of those measurements associated with a display point. For example, if there are 3 measurement frequencies associated with a given display point, sample detection will display the value at the frequency of the second measurement point.

Parameter: POSitive|RMS|NEGative|SAMPLE

Parameter Type: <char>

Default Value: (Positive) Peak

Front Panel

Access: Amplitude, Detection

**[:SENSe]:EMF:STATe OFF|ON|0|1
[:SENSe]:EMF:STATe?**

Title: EMF State

Description: Switches EMF ON or OFF.

The query form of this command returns a 0 or 1 when EMF state is OFF or ON, respectively.

Note: EMF will turn ON only if the start and stop frequencies are within the frequency range of the spectrum analyzer and isotropic antenna used. The antenna must be connected.

Parameter: OFF|ON|0|1

Parameter Type: <boolean>

Default Value: OFF

Front Panel

Access: Shift-4 (Measure), Power and Bandwidth, EMF Measurement, On/Off

[:SENSe]:EXTRefstatus?

Title: Frequency Reference Status

Description: Returns 0 for internal or GPS reference. Returns 1 for external reference.

Front Panel

Access: None

[:SENSe]:FREQUENCY:CENTer <freq>

[:SENSe]:FREQUENCY:CENTer?

Title: Center Frequency

Description: Sets the center frequency. Note that changing the value of the center frequency will change the value of the coupled parameters Start Frequency and Stop Frequency. It may also change the value of the span.

Parameter: <freq>

Default Unit: Hz

Front Panel

Access: Freq, Center Freq

[:SENSe]:FREQUENCY:SIGStandard:CHANnel <number>

[:SENSe]:FREQUENCY:SIGStandard:CHANnel?

Title: Channel Selection

Description: Sets the channel number for the selected signal standard.

Parameter: <number>

Front Panel

Access: Freq, Channel

[:SENSe]:FREQUENCY:SIGStandard:NAME <string>

[:SENSe]:FREQUENCY:SIGStandard:NAME?

Title: Signal Standard

Description: Selects the desired signal standard from the list. The <string> argument is the name of the desired signal standard as displayed in the instrument's current signal standard list. The list can be displayed on the instrument by choosing the Signal Standard submenu button in the Freq menu. The list can also be downloaded remotely and viewed using Anritsu Master Software Tools. For example, if the desired Signal Standard is P-GSM 900 - Uplink, then the value of the <string> argument would be "P-GSM 900 - Uplink".

The query form of this command will return the name of the currently selected Signal Standard on the list.

Parameter: <string>

Front Panel

Access: Freq, Signal Standard

[:SENSe]:FREQuency:SPAN <freq>**[:SENSe]:FREQuency:SPAN?**

Title: Frequency Span

Description: Sets the frequency span. Setting the value of <freq> to 0 Hz is the equivalent of setting the span mode to zero span. Note that changing the value of the frequency span will change the value of the coupled parameters Start Frequency and Stop Frequency and may change the Center Frequency.

Parameter: <freq>

Default Unit: Hz

[:SENSe]:FREQuency:SPAN:FULL

Title: Frequency Span – Full

Description: Sets the frequency span to full span. Note that changing the value of the frequency span will change the value of the coupled parameters, Start Frequency and Stop Frequency and may change the Center Frequency.

Front Panel

Access: Span, Full Span

[:SENSe]:FREQuency:SPAN:PREVious

Title: Frequency Span – Last

Description: Sets the frequency span to the previous span value. Note that changing the value of the frequency span will change the value of the coupled parameters, Start Frequency and Stop Frequency and may change the Center Frequency.

Default Unit: Hz

Front Panel

Access: Span, Last Span

[:SENSe]:FREQuency:START <freq>**[:SENSe]:FREQuency:START?**

Title: Start Frequency

Description: Sets the start frequency. Note that in the spectrum analyzer, changing the value of the start frequency will change the value of the coupled parameters, Center Frequency and Span.

Parameter: <freq>

Default Value: 0 Hz

Default Unit: Hz

Related Command: [:SENSe]:FREQuency:STOP?

Front Panel

Access: Freq, Start Freq

[:SENSE]:FREQUENCY:STEP[:INCREMENT] <freq>
[:SENSE]:FREQUENCY:STEP[:INCREMENT]?

Title: Frequency Step

Description: Sets the frequency step to the given frequency value.

Parameter: <freq>

Default Value: 1 MHz

Default Unit: Hz

Range: 1 Hz to 20 GHz

Front Panel

Access: Freq, Step Size & Offset, Freq Step

Note

Setting the frequency step size above the maximum span of the instrument will cause the maximum value to be set for the Center Freq, Start Freq or Stop Freq submenu key when the up arrow key is pressed and the minimum value set when the down arrow key is pressed.

[:SENSE]:FREQUENCY:STOP <freq>
[:SENSE]:FREQUENCY:STOP?

Title: Stop Frequency

Description: Sets the stop frequency. Note that in the spectrum analyzer, changing the value of the stop frequency will change the value of the coupled parameters, Center Frequency and Span.

Parameter: <freq>

Default Unit: Hz

[:SENSE]:FSTRENGTH:ANTENNA <antenna>
[:SENSE]:FSTRENGTH:ANTENNA?

Title: Field Strength Antenna

Description: Selects an antenna from the antenna list to use for field strength measurement result calculations. The <antenna> argument is a 1-based index of the position of the desired antenna in the instrument's current antenna list. The list can be displayed on the instrument by choosing the "Antenna" submenu button in the "F Strength" menu. For example, if the desired antenna were the 3rd item on the antenna listing, then the value of the <antenna> argument would be 3.

The <antenna> value for EMI antenna list starts from 65.

The query form of this command will return the index of the currently selected antenna.

Note	An invalid selection will return a zero when queried.
-------------	---

Parameter: <antenna>

Default Value: 1

Related Command: :CONFigure:FSTReNgtH

Front Panel

Access: Shift-4 (Measure), Power and Bandwidth, Field Strength, Antenna

[:SENSe]:FSTReNgtH:STATe OFF|ON|0|1

[:SENSe]:FSTReNgtH:STATe?

Title: Field Strength Measurement State

Description: Sets the state of the field strength measurement, ON or OFF. When using :CONFigure:FSTReNgtH, the state is automatically set to ON.

Parameter: OFF|ON|0|1

Parameter Type: <boolean>

Default Value: OFF

Related Command: :CONFigure:CHPower

Front Panel

Access: Shift-4 (Measure), Power and Bandwidth, Field Strength, On/Off

[:SENSe]:OBWidth:METHod XDB|PERCent

[:SENSe]:OBWidth:METHod?

Title: Occupied Bandwidth Measurement Method

Description: Sets the method for calculating occupied bandwidth. XDB calculates the occupied bandwidth based on points a specified number of dB below the carrier. Issue command [:SENSe]:OBWidth:XDB to set the number of dB to be used. PERCent calculates the occupied bandwidth based on points a specified percentage of the carrier power below the carrier. Issue command [:SENSe]:OBWidth:PERCent to set the percentage to be used.

Parameter: XDB|PERCent

Parameter Type: <char>

Default Value: PERCent

Related Command: [:SENSe]:OBWidth:XDB [:SENSe]:OBWidth:PERCent

Front Panel

Access: Shift-4 (Measure), Power and Bandwidth, OCC BW

[:SENSE]:OBWidth:PERCent <percentage>

[:SENSE]:OBWidth:PERCent?

Title: Occupied Bandwidth Percent of Power

Description: This command sets the percentage of carrier power used to measure the occupied bandwidth. This value is used in the measurement if :SENSE:OBWidth:METHOD is set to PERCent.

Parameter: <percentage>

Default Value: 99

Default Unit: %

Range: 0% to 100%

Related Command: [:SENSE]:OBWidth:METHOD

Front Panel

Access: Shift-4 (Measure), Power and Bandwidth, OCC BW, %

[:SENSE]:OBWidth:STATE OFF|ON|0|1

[:SENSE]:OBWidth:STATE?

Title: Occupied Bandwidth Measurement State

Description: Sets the state of the occupied bandwidth measurement, ON or OFF. When using :CONFIGure:OBWidth, the state is automatically set to ON.

Parameter: OFF|ON|0|1

Parameter Type: <boolean>

Default Value: OFF

Related Command: :CONFIGure:OBWidth

Front Panel

Access: Shift-4 (Measure), Power and Bandwidth, OCC BW, On/Off

[:SENSE]:OBWidth:XDB <rel ampl>

[:SENSE]:OBWidth:XDB?

Title: Occupied Bandwidth dB Down

Description: This command sets the number of dB below the carrier used to measure the occupied bandwidth. This value is used in the measurement if :SENSE:OBWidth:METHOD is set to XDB.

Parameter: <rel ampl>

Default Value: 3 dBc

Default Unit: dBc

Range: 0 to 100 dBc

Related Command: [:SENSE]:OBWidth:METHOD

Front Panel

Access: Shift-4 (Measure), Power and Bandwidth, OCC BW, dBc

[:SENSe]:OPTion:IF:BWStAtE 1|2|3|4|5
:SENSe:OPTion:IF:BWStAtE?

Title: IF Bandwidth State

Description: Sets the IF Bandwidth. Setting a value of 1 is equivalent of setting the IF Bandwidth to Normal on the front panel. Setting a value of 3 is equivalent of setting the IF Bandwidth to 10 MHz BW on the front panel. Setting the value of 4 is equivalent of setting the IF Bandwidth to 16 MHz BW on the front panel. Note that option 89 must be available and in Zero span for the command to be valid. The query version of this command will return a 0 if not in zero span.

Parameter: 1|2|3|4|5

Range: 1|2|3|4|5

[:SENSe]:POWer[:RF]:ATTenuation <rel ampl>
:SENSe:POWer[:RF]:ATTenuation?

Title: Input Attenuation

Description: Sets the input attenuation. Note that issuing this command will set the automatic input attenuation OFF.

Parameter: <rel ampl>

Default Value: 30 dB

Default Unit: dB

Range: 0 dB to 65 dB

Related Command: [:SENSe]:POWer[:RF]:ATTenuation:AUTO

Front Panel

Access: Amplitude, Atten Lvl

[:SENSe]:POWer[:RF]:ATTenuation:AUTO OFF|ON|0|1

[:SENSe]:POWer[:RF]:ATTenuation:AUTO?

Title: Input Attenuation Coupling

Description: Sets the input attenuation coupling. Setting the value to ON or 1 will result in the input attenuation being coupled to the reference level. Setting the value to OFF or 0 will result in the input attenuation being un-coupled from the reference level. That is, changing the reference level will not change the input attenuation. When this command is issued, the input attenuator setting itself will not change. The default value is ON. That is, sending :SENS:POW:ATT:AUTO is equivalent to sending :SENS:POW:ATT:AUTO ON.

Parameter: OFF|ON|0|1

Parameter Type: <boolean>

Default Value: ON

Related Command: [:SENSe]:POWer[:RF]:ATTenuation

Front Panel

Access: Amplitude, Auto Atten

[:SENSe]:POWer[:RF]:GAIN[:STATe] OFF|ON|0|1
[:SENSe]:POWer[:RF]:GAIN[:STATe]?

Title: Preamp State

Description: Sets the state of the preamp. Note that this may cause a change in the reference level and/or attenuation.

Note: The MS2711E returns a value of -1 if Preamp (Option 8) is not installed.

Parameter: OFF|ON|0|1

Parameter Type: <boolean>

Default Value: OFF

Front Panel

Access: Amplitude, Pre Amp

[:SENSe]:SWEep:MODE FAST|PERFormance|NOFFt
[:SENSe]:SWEep:MODE?

Title: Sweep Mode

Description: Sets the sweep mode to Fast, Performance or No FFT. The query from of this command returns the current sweep mode short form.

Note: FAST Sweep Mode is not available for the MS2711E.

Parameter: FAST|PERFormance|NOFFt

Parameter Type: <char>

Front Panel

Access: Shift-3 (Sweep), Sweep Mode

[:SENSe]:SWEep:STATus?

Title: Sweep Status

Description: Returns 1 when the sweep is complete. Returns 0 when the sweep is in progress.

Front Panel

Access: None

[:SENSe]:SWEep:TIME[:LLIMit]
[:SENSe]:SWEep:TIME[:LLIMit]?

Title: Minimum Sweep Time

Description: Sets the value of the minimum sweep time parameter. The sweep will complete in the shortest time possible. To sweep as fast as possible, enter the minimum value allowed for the sweep time.

Default Value: 0.001

Default Unit: Seconds

Range: 10 μ s to 600000000 μ s

Front Panel

Access: Shift-3 (Sweep), Sweep Time

[:SENSe]:SWEep:TIME:ACTual?

Title: Actual Sweep Time

Description: Returns the actual sweep time as opposed to the specified sweep time.

Default Unit: Seconds

[:SENSe]:SWEep:TIME:AUTO ON|OFF|1|0
[:SENSe]:SWEep:TIME:AUTO?

Title: Auto Sweep Time

Description: Sets Auto Sweep Time on or off.

Front Panel

Access: Shift-3 (Sweep), Auto Sweep Time

[:SENSe]:SWEep:TRACe?

Title: Trace Count

Description: Returns a string with two integers representing the current trace's average count and the total number of trace averages.

Front Panel

Access: None

Chapter 6 — GSM Commands

6-1 :ABORt Subsystem

The abort subsystem includes commands that allow the user to stop current measurement activities on the instrument.

:ABORt

Title: Abort

Description: Restarts the current sweep and/or measurement. Resets the trigger system. If :INITiate:CONTinuous is OFF (i.e. the instrument is in single sweep mode), send the command :INITiate[:IMMediate] to trigger the next sweep. If :INITiate:CONTinuous is ON (i.e. the instrument is in continuous sweep mode), a new sweep will start immediately.

Parameter: NA

Related Command: :INITiate:CONTinuous
:INITiate[:IMMediate]

6-2 :CONFigure Subsystem

This set of commands prepares the instrument for the selected measurement. It disables any currently-enabled measurements and activates the specified measurement. It sets the instrument to single sweep mode, waiting for an :INITiate command. It will not initiate the taking of a measurement.

Current instrument settings may be changed to default values. These changes are identified with their respective measurement commands.

:CONFigure:SUMMARY

Title: Configure Summary Measurement

Description: This command configures the summary of all the related numerical measurement results. It disables any other active measurements. None of the instrument parameters are changed by the execution of this command. Sets the instrument to single sweep mode (:INITiate:CONTinuous OFF). Measurement settings can be modified by using the [:SENSE] commands before initiating a measurement.

Front Panel

Access: Shift-4 (Measure), GSM/EDGE Summary

:CONFigure:DEMod

Title: Configure Demodulation Measurement

Required Option: 41

Description: This command configures the Demodulator measurement. It disables any other active measurements. None of the instrument parameters are changed by the execution of this command. Sets the instrument to single sweep mode (:INITiate:CONTinuous OFF). Measurement settings can be modified by using the [:SENSE] commands before initiating a measurement.

Front Panel

Access: Shift-4 (Measure), Demodulator

:CONFigure:PFail

Title: Configure PASS/FAIL Measurement

Description: This command configures the PASS/FAIL measurement. It disables any other active measurements. None of the instrument parameters are changed by the execution of this command. Sets the instrument to single sweep mode (:INITiate:CONTinuous OFF). Measurement settings can be modified by using the [:SENSE] commands before initiating a measurement. The measurement results are equivalent to the results that are displayed by choosing Measurements, then Pass/Fail mode from the front panel.

Related Command: :FETCh:PFail?
MEASure:PFail?
READ:PFail?

Front Panel

Access: Shift-4 (Measure), Pass/Fail Mode

:CONFigure:PVTFFrame

Title: Configure Power vs. Time (Frame) Measurement

Required Option: 40

Description: This command configures the Power vs. Time (Frame) measurement. It disables any other active measurements. None of the instrument parameters are changed by the execution of this command. Sets the instrument to single sweep mode (:INITiate:CONTinuous OFF). Measurement settings can be modified by using the [:SENSE] commands before initiating a measurement.

Related Command: MEASure:PVTFFrame?
READ:PVTFFrame?
FETCh:PVTFFrame?

Front Panel

Access: Shift-4 (Measure), Power vs. Time (Frame)

:CONFigure:PVTSlot

Title: Configure Power vs. Time (Slot) Measurement

Required Option: 40

Description: This command configures the Power vs. Time (Slot) measurement. It disables any other active measurements. None of the instrument parameters are changed by the execution of this command. Sets the instrument to single sweep mode (:INITiate:CONTinuous OFF). Measurement settings can be modified by using the [:SENSe] commands before initiating a measurement.

Related Command: MEASure:PVTSlot?
READ:PVTSlot?
FETCh:PVTSlot?

Front Panel

Access: Shift-4 (Measure), Power vs. Time (Slot)

:CONFigure:SPECTrum:MULTi

Title: Configure Multi-Channel Spectrum Measurement

Required Option: 40

Description: This command configures the Multi-Channel Spectrum measurement. It disables any other active measurements. None of the instrument parameters are changed by the execution of this command. Sets the instrument to single sweep mode (:INITiate:CONTinuous OFF). Measurement settings can be modified by using the [:SENSe]:RF commands before initiating a measurement.

Front Panel

Access: Shift-4 (Measure), Spectrum, Multi-Channel Spectrum

:CONFigure:SPECTrum:SINGLE

Title: Configure Single Channel Spectrum Measurement

Required Option: 40

Description: This command configures the Single Channel Spectrum measurement. It disables any other active measurements. None of the instrument parameters are changed by the execution of this command. Sets the instrument to single sweep mode (:INITiate:CONTinuous OFF). Measurement settings can be modified by using the [:SENSe]:RF commands before initiating a measurement.

Related Command: MEASure:SPECTrum:SINGLE?
READ:SPECTrum:SINGLE?
FETCh:SPECTrum:SINGLE?

Front Panel

Access: Shift-4 (Measure), Spectrum, Channel Spectrum

:CONFigure?

Title: Configure Query

Description: :CONFigure? query returns the name of the measurement previously set up using a CONFigure command or a MEASure? query. The list below shows the possible return values and the actual names of each configuration.

Returns Value	Actual Name
SPEC, SING	Single Channel Spectrum
SPEC, MULT	Multi-Channel Spectrum
PVTF	Power vs. Time (Frame)
PVTS	Power vs. Time (Slot)
DEM	Demodulator
PF	Pass/Fail Mode
SUMM	Summary

6-3 :DISPlay Subsystem

This subsystem provides commands that modify the display of data for the user. They do not modify the way in which data are returned to the controller.

:DISPlay:WINDow:TRACe:Y[:SCALE]:OFFSet <rel ampl>

:DISPlay:WINDow:TRACe:Y[:SCALE]:OFFSet?

Title: Power Offset

Description: Sets the power offset value for the y-axis.

Parameter: <rel ampl>

Default Value: 0 dB

Default Unit: dB

Range: -100 dB to 100 dB

Front Panel

Access: Amplitude, Power Offset

6-4 :FETCh Subsystem

This set of commands returns the most recent measurement data of the active measurement. They will not switch to another measurement.

To make a new measurement, use the INITiate command. To get new measurement data, use the READ or MEASure query commands.

:FETCh:DEMod?

Title: Fetch Demodulator

Required Option: 41

Description: Returns the most recent Demodulator measurement results. The Demodulator measurement must be the active measurement. The current measurement can be queried using CONFigure?. Use the CONFigure:DEMod command to set Demodulator as the active measurement.

Data is returned as 9 comma-delimited values: Phase Error (rms), Phase Error (peak), EVM (rms) in %, EVM (peak) in %, Origin Offset in dB, C/I in dB, Magnitude Error (rms) in %, Modulation Type, and TSC. “-.” is returned for data that is not valid at that instance.

Related Command: MEASure:DEMod?
CONFigure:DEMod
READ:DEMod?

:FETCh:PFail?

Title: Fetch PASS/FAIL

Description: Returns the most recent PASS/FAIL measurement results. Measurement results are returned in a block of ASCII text in the format of <header><block>. The ASCII header specifies the number of data bytes. It looks like #AX, where A is the number of digits in X and X is the number of bytes in the <block>. The block consists of a set of records which indicate individual test results. Records are comma-separated. Each record follows the format <test ID>: <input1> <input2> <min> <max> <value1> <value2> <PASS/FAIL/OPTION NOT INSTALLED>. The <test ID> field indicates which test was performed to retrieve these results. The <input1> and <input2> fields indicate the test setup. The

<min> and <max> fields indicate the minimum and maximum values against which <value1> and <value2> were compared to arrive at the final PASS/FAIL result. If the specified test is not available in the instrument, the <PASS/FAIL> field will indicate “option not available” instead of “pass” or “fail”. All unused fields for a given test are represented by a double dash (“--”). To receive valid measurements, the Pass/Fail measurement must be the active. The current measurement can be queried using CONFigure?. Use the :CONFigure:PFail to set Pass/Fail as the active measurement.

Related Command: MEASure:PFail?
:CONFigure:PFail
READ:PFail?

:FETCh:PVTFrame?

Title: Fetch Power vs. Time (Frame)

Required Option: 40

Description: Returns the most recent Power vs. Time (Frame) measurement results. The Power vs. Time (Frame) measurement must be the active measurement. The current measurement can be queried using CONFigure?. Use the CONFigure:PVTFrame command to set Power vs. Time (Frame) as the active measurement.

Data is returned as 9 comma-delimited values: Channel Power in dBm, Burst Power in dBm, Average Burst Power in dBm, Span in MHz, Occupied Bandwidth in MHz, Frequency Error in MHz, Frequency Error in ppb, Modulation Type, and TSC. “--” is returned for each data that is not valid at that instance.

Related Command: MEASure:PVTFrame?
CONFigure:PVTFrame
READ:PVTFrame?

:FETCh:PVTSlot?

Title: Fetch Power vs. Time (Slot)

Required Option: 40

Description: Returns the most recent Power vs. Time (Slot) measurement results. The Power vs. Time (Slot) measurement must be the active measurement. The current measurement can be queried using CONFigure?. Use the CONFigure:PVTSlot command to set Power vs. Time (Slot) as the active measurement.

Data is returned as 9 comma-delimited values: Channel Power in dBm, Burst Power in dBm, Average Burst Power in dBm, Span in MHz, Occupied Bandwidth in MHz, Frequency Error in MHz, Frequency Error in ppb, Modulation Type, and TSC. “--” is returned for each data that is not valid at that instance.

:FETCh:SPECTrum:MULTi?

Title: Fetch Multi-Channel Spectrum

Required Option: 40

Description: Returns the most recent Multi-Channel Spectrum measurement results. The Multi-Channel Spectrum measurement must be the active measurement. The current measurement can be queried using CONFigure?. Use the CONFigure:SPECTrum:MULTi command to set Multi-Channel Spectrum as the active measurement.

Data is returned as 1 value: Span in MHz.

Related Command: MEASure:SPECTrum:MULTi?
:CONFigure:SPECTrum:MULTi
READ:SPECTrum:MULTi?

:FETCh:SPECTrum:SINGLE?

Title: Fetch Single Channel Spectrum

Required Option: 40

Description: Returns the most recent Single Channel Spectrum measurement results. The Single Channel Spectrum measurement must be the active measurement. The current measurement can be queried using CONFigure?. Use the CONFigure:SPECTrum:SINGLE command to set Single Channel Spectrum as the active measurement.

Data is returned as 9 comma-delimited values: Channel Power in dBm, Burst Power in dBm, Average Burst Power in dBm, Span in MHz, Occupied Bandwidth in MHz, Frequency Error in MHz, Frequency Error in ppb, Modulation Type, and TSC. "--" is returned for each data that is not valid at that instance.

Related Command: MEASure:PVTSlot?
:CONFigure:PVTSlot
READ:PVTSlot?

6-5 :FORMat Subsystem

This subsystem contains commands that determine the formatting of numeric data when it is transferred.

The format setting affects data in specific commands only. If a command is affected, it is noted in the command description.

:FORMat[:READings][:DATA] ASCii|INTeger,32|REAL,32

:FORMat[:READings][:DATA]?

Title: Numeric Data Format

Description: This command specifies the format in which data is returned in certain commands.

ASCii format returns the data in comma-separated ASCII format. The units are the current instrument units. This format requires many more bytes so it is the slowest format. INTeger,32 values are signed 32-bit integers in little-endian byte order. This format returns the data in 4-byte blocks. REAL,32 values are 32-bit floating point numbers conforming to the IEEE 754 standard in little-endian byte order. This format returns the data in 4-byte binary format. The units are the current instrument units.

Both INTeger,32 and REAL,32 formats return a definite block length. Each transfer begins with an ASCII header such as #42204. The first digit represents the number of following digits in the header (in this example, 4). The remainder of the header indicates the number of bytes that follow the header (in this example, 2204). You then divide the number of following bytes by the number of bytes in the data format you've chosen (4 for both INTeger,32 and REAL,32) to get the number of data points (in this example, 551).

Parameter: ASCii|INTeger,32|REAL,32

Parameter Type: <char>

Default Value: ASCii

Related Command: :TRACe[:DATA]

6-6 :INITiate Subsystem

This subsystem controls the triggering of measurements.

:INITiate:CONTInuous OFF|ON|0|1

:INITiate:CONTInuous?

Title: Continuous/Single Sweep

Description: Specifies whether the sweep/measurement is triggered continuously. If the value is set to ON or 1, another sweep/measurement is triggered as soon as the current one completes. If continuous is set to OFF or 0, the instrument enters the “idle” state and waits for the :INITiate[:IMMEDIATE] command or for :INITiate:CONTInuous ON. The default value is ON. That is, sending :INIT:CONT is equivalent to sending :INIT:CONT ON. The query version of the command returns a 1 if the instrument is continuously sweeping/measuring and returns a 0 if the instrument is in single sweep/measurement mode. Note that rapid toggling between ON and OFF is not allowed. The instrument must be allowed to make a full sweep before toggling can be done.

Parameter: OFF|ON|0|1

Parameter Type: <boolean>

Default Value: ON

Related Command: :INITiate[:IMMEDIATE]

Front Panel

Access: Shift-3 (Sweep), Sweep

:INITiate[:IMMEDIATE]

Title: Trigger Sweep/Measurement

Description: Initiates a sweep/measurement. If :INITiate:CONTInuous is set to ON, this command is ignored. Use this command in combination with :STATus:OPERation? to synchronize the capture of one complete set of data. When this command is sent, the “sweep complete” bit of :STATus:OPERation? is set to 0, indicating that the measurement has not completed. The data collection is then triggered. The controlling program can poll :STATus:OPERation? to determine the status. When the “sweep complete” bit is set to 1, data is ready to be retrieved.

Related Command: :INITiate:CONTInuous
:STATus:OPERation?

Front Panel

Access: Shift-3 (Sweep), Trigger Sweep

6-7 :MEASure Subsystem

These commands take the instrument from its current state, enable the specified measurement and put the instrument into single sweep mode. They correct any parameters that are invalid given the new measurement state such that a valid measurement can take place. Other settings may be changed; see the documentation of CONFigure for each measurement. They then initiate the measurement. When the measurement is complete, they return the result.

To make a measurement with settings other than the “default” measurement settings applied by CONFigure, do the following:

- Send the appropriate CONFigure command to set the desired measurement.
- Modify the settings as required.
- Send the appropriate READ command to measure and return the result.

To get the current measurement data, use the appropriate FETCh command.

:MEASure:DEMod?

Title: Measure Demodulator

Required Option: 41

Description: Sets the active measurement to Demodulator, sets the default measurement parameters, triggers a new measurement and returns the Phase Error (rms), Phase Error (peak), EVM (rms), EVM (peak), Origin Offset, C/I, Magnitude Error (rms), Modulation Type, and TSC measurement. It is a combination of the commands :CONFigure:DEMod and :READ:DEMod? To make a Demodulator measurement with settings other than the default values, send:

```
CONFigure:DEMod
Commands to set desired settings
READ:DEMod?
```

Data is returned as 9 comma-delimited values: Phase Error (rms), Phase Error (peak), EVM (rms) in %, EVM (peak) in %, Origin Offset in dB, C/I in dB, Magnitude Error (rms) in %, Modulation Type, and TSC.

“..” is returned for each data that is not valid at that instance.

Related Command: CONFigure:DEMod
READ:DEMod?
FETCh:DEMod?

Front Panel

Access: Shift-4 (Measure), Demodulator

:MEASure:PFail?

Title: Measure PASS/FAIL

Description: Sets the active measurement to PASS/FAIL, sets the default measurement parameters, triggers a new measurement and returns the PASS/FAIL results. It is a combination of the commands :CONFigure:PFail; and :READ:PFail? To make a PASS/FAIL measurement with settings other than the default values, send:

:CONFigure:PFail

Commands to set desired settings

:READ:PFail?

Related Command: :CONFigure:PFail

READ:PFail?

FETCh:PFail?

Front Panel

Access: Shift-4 (Measure), PASS/FAIL mode

:MEASure:PVTFrame?

Title: Measure Power vs. Time (Frame)

Required Option: 40

Description: Sets the active measurement to Power vs. Time (Frame), sets the default measurement parameters, triggers a new measurement and returns the Channel Power, Burst Power, Average Burst Power, Span, Occupied Bandwidth, Frequency Error, Frequency Error (ppm), Modulation Type, and TSC measurement. It is a combination of the commands :CONFigure:PVTFrame and :READ:PVTFrame? To make a Power vs. Time (Frame) measurement with settings other than the default values, send:

:CONFigure:PVTFrame

Commands to set desired settings

READ:PVTFrame?

Data is returned as 9 comma-delimited values: Channel Power in dBm, Burst Power in dBm, Average Burst Power in dBm, Span in MHz, Occupied Bandwidth in MHz, Frequency Error in MHz, Frequency Error (ppm), Modulation Type, and TSC. "--" is returned for each data that is not valid at that instance.

:MEASure:PVTSlot?

Title: Measure Power vs. Time (Slot)

Required Option: 40

Description: Sets the active measurement to Power vs. Time (Slot), sets the default measurement parameters, triggers a new measurement and returns the Channel Power, Burst Power, Average Burst Power, Span, Occupied Bandwidth, Frequency Error, Frequency Error (ppm), Modulation Type, and TSC measurement. It is a combination of the commands :CONFigure:PVTSlot and :READ:PVTSlot? To make a Power vs. Time (Slot) measurement with settings other than the default values, send:

CONFigure:PVTSlot

Commands to set desired settings

READ:PVTSlot?

Data is returned as 9 comma-delimited values: Channel Power in dBm, Burst Power in dBm, Average Burst Power in dBm, Span in MHz, Occupied Bandwidth in MHz, Frequency Error in MHz, Frequency Error (ppm), Modulation Type, and TSC. "--" is returned for each data that is not valid at that instance.

Related Command: CONFigure:PVTSlot
:READ:PVTSlot?
:FETCh:PVTSlot?

Front Panel

Access: Shift-4 (Measure), Power vs. Time (Slot)

:MEASure:SPECTrum:MULTi?

Title: Measure Multi-Channel Spectrum

Required Option: 40

Description: Sets the active measurement to Multi-Channel Spectrum, sets the default measurement parameters, triggers a new measurement and returns the Span. It is a combination of the commands :CONFigure:SPECTrum:MULTi and :READ:SPECTrum:MULTi? To make a Multi-Channel Spectrum measurement with settings other than the default values, send:

CONFigure:SPECTrum:MULTi
Commands to set desired settings
READ:SPECTrum:MULTi?

Data is returned as 1 value: Span in MHz.

Related Command: CONFigure:SPECTrum:MULTi
:READ:SPECTrum:MULTi?
FETCh:SPECTrum:MULTi?

Front Panel

Access: Shift-4 (Measure), Spectrum, Multi-Channel Spectrum

:MEASure:SPECTrum:SINGLE?

Title: Measure Single Channel Spectrum

Required Option: 40

Description: Sets the active measurement to Single Channel Spectrum, sets the default measurement parameters, triggers a new measurement and returns the Channel Power, Burst Power, Average Burst Power, Span, Occupied Bandwidth, Frequency Error, Frequency Error (ppm), Modulation Type, and TSC measurement. It is a combination of the commands :CONFigure:SPECTrum:SINGLE and :READ:SPECTrum:SINGLE? To make a Single Channel Spectrum measurement with settings other than the default values, send:

CONFigure:SPECTrum:SINGLE
Commands to set desired settings
READ:SPECTrum:SINGLE?

Data is returned as 9 comma-delimited values: Channel Power in dBm, Burst Power in dBm, Average Burst Power in dBm, Span in MHz, Occupied Bandwidth in MHz, Frequency Error in MHz, Frequency Error (ppm), Modulation Type, and TSC. "--" is returned for each data that is not valid at that instance.

Related Command: CONFigure:SPECTrum:SINGLE
:READ:SPECTrum:SINGLE?
:FETCh:SPECTrum:SINGLE?

Front Panel

Access: Shift-4 (Measure), Spectrum, Channel Spectrum

6-8 :MMEMory Subsystem

The Mass Memory subsystem contains functions that provide access to the instrument's setup and data storage.

:MMEMory:DELeTe <filename>

Title: Delete Setup/Measurement

Description: Removes a file specified by <filename> from the current mass storage device. <filename> should be enclosed in either single quotes (') or double quotes (") and it must include the file extension. Use the command MMEMory:MSIS to set the current file location.

Parameter: <filename>

Related Command: :MMEMory:STORE:STATE
:MMEMory:STORE:TRACe
:MMEMory:MSIS INTernal|USB

Front Panel

Access: Shift-7 (File), Delete, Delete Selected File

:MMEMory:LOAD:TRACe <integer>,<filename>

Title: Recall Measurement

Description: The instrument must be in the mode of the saved trace in order to recall that trace. Use :INSTRument:SELEct or :INSTRument:NSELEct to set the mode.

Recalls a previously stored measurement trace from the current save location. The saved measurement trace to be loaded is specified by <filename>. <filename> should be enclosed in either single quotes (') or double quotes (") and should contain a file extension. Note that the trace specified by <filename> should be available at the current save location. Use the command MMEMory:MSIS to set the current save location. The <integer> parameter is not currently used, but it must be sent. Send a 1.

File name extensions:

“.edg” for GSM
 “.spa” for SPA
 “.wcd” for WCDMA
 “.wmx” for WiMAX
 “.wmx” for Mobile WiMAX
 “.vna” for Cable & Antenna
 “.cdma” for CDMA
 “.tds” for TDSCDMA
 “.evdo” for EVDO
 “.ia” for Interference Analysis
 “.cs” for Channel Scanner
 “.pm” for Power Meter
 “.tm” for Transmission Measurement
 “.lte” for LTE Analyzer

Note: Extensions not available for T1 and Hi_PM.

Parameter: <integer>, <filename>

Example: To recall trace with file name “trace”:
 :MMEMory:LOAD:TRACe 1,“trace.spa”

Related Command: :MMEMory:STORe:TRACe
 :MMEMory:STORe:TRACe
 :MMEMory:MSIS INTernal|USB

Front Panel

Access: Shift-7 (File), Recall Measurement

:MMEMory:LOAD:STATe <integer>,<filename>

Title: Recall Setup

Description: Recalls a previously stored instrument setup in the current save location. The setup file to be loaded is specified by <filename>. <filename> should be enclosed in either single quotes (') or double quotes (") and should contain a file extension ".stp". Use the command MMEMory:MSIS to set the current save location. The <integer> parameter is not currently used, but it must be sent. Send a 1.

Parameter: <integer>, <filename>

Related Command: :MMEMory:STORe:STATe
:MMEMory:MSIS INTernal|USB

Front Panel

Access: Shift-7 (File), Recall

:MMEMory:STORe:STATe <integer>,<filename>

Title: Save Setup

Description: Stores the current setup into the file specified by <filename>. <filename> should be enclosed in either single quotes (') or double quotes (") and should not contain a file extension. Use the command MMEMory:MSIS to set the current save location. The <integer> parameter is not currently used, but it must be sent. Send a value of 0.

Parameter: <integer>, <filename>

Related Command: :MMEMory:LOAD:STATe
:MMEMory:MSIS INTernal|USB

Front Panel

Access: Shift-7 (File)

:MMEMory:STORe:TRACe <integer>,<filename>

Title: Save Measurement

Description: Stores the trace into the file specified by <filename>. <filename> should be enclosed in either single quotes (') or double quotes (") and should not contain a file extension. Use the command MMEMory:MSIS to set the current save location. The <integer> parameter is not currently used, but it must be sent. Send a 0. Note that existing files of the same name will not be overwritten.

Parameter: <integer>, <filename>

Example: To save the trace into the file name "trace":

```
:MMEMory:STORe:TRACe 0,"trace"
```

Related Comman: :MMEMory:LOAD:TRACe
:MMEMory:MSIS INTernal|USB

Front Panel

Access: Shift-7 (File), Save

6-9 :READ Subsystem

This set of commands combines the ABORT, INITiate and FETCh commands. It aborts any current triggering sequence and sets the trigger state to idle. It then initiates a new active measurement (i.e. begins the collection of new data). When the measurement is complete, it returns the result. These commands will not switch to another measurement.

To get the current measurement data, use the FETCh command.

:READ:DEMod?

Title: Read Demodulator

Required Option: 41

Description: Triggers a new Demodulator measurement and returns the results: Phase Error (rms), Phase Error (peak), EVM (rms), EVM (peak), Origin Offset, C/I, Magnitude Error (rms), Modulation Type, and TSC measurement. It is a combination of the commands :ABORT; :INITiate; :FETCh:DEMod? The Demodulator measurement must be the active measurement (specified by CONFigure:DEMod). The current measurement can be queried using CONFigure?

Data is returned as 9 comma-delimited values: Phase Error (rms), Phase Error (peak), EVM (rms) in %, EVM (peak) in %, Origin Offset in dB, C/I in dB, Magnitude Error (rms) in %, Modulation Type, and TSC. "--" is returned for each data that is not valid at that instance.

Related Command: MEASure:DEMod?
:CONFigure:DEMod
:FETCh:DEMod?

Front Panel

Access: Shift-4 (Measure), Demodulator

:READ:PFail?

Title: Read PASS/FAIL

Description: Triggers a new PASS/FAIL measurement and returns the results. It is a combination of the commands :ABORT; :INITiate; :FETCh:PFail? The PASS/FAIL measurement must be active. The current measurement can be queried using :CONFigure?

Related Command: MEASure:PFail?
:CONFigure:PFail
FETCh:PFail?
:CONFigure:PFail

Front Panel

Access: Shift-4 (Measure), PASS/FAIL Mode

:READ:PVTFrame?

Title: Read Power vs. Time (Frame)

Required Option: 40

Description: Triggers a new Power vs. Time (Frame) measurement and returns the results: Channel Power, Burst Power, Average Burst Power, Span, Occupied Bandwidth, Frequency Error, Frequency Error (ppm), Modulation Type, and TSC measurement. It is a combination of the commands :ABORT; :INITiate; :FETCh:PVTFrame? The Power vs. Time (Frame) measurement must be the active measurement (specified by CONFigure:PVTFrame). The current measurement can be queried using CONFigure?

Data is returned as 9 comma-delimited values: Channel Power in dBm, Burst Power in dBm, Average Burst Power in dBm, Span in MHz, Occupied Bandwidth in MHz, Frequency Error in MHz, Frequency Error (ppm), Modulation Type, and TSC. "--" is returned for each data that is not valid at that instance.

Related Command: MEASure:PVTFrame?
:CONFigure:PVTFrame
:FETCh:PVTFrame?

Front Panel

Access: Shift-4 (Measure), Power vs. Time (Frame)

:READ:PVTSlot?

Title: Read Power vs. Time (Slot)

Required Option: 40

Description: Triggers a new Power vs. Time (Slot) measurement and returns the results: Channel Power, Burst Power, Average Burst Power, Span, Occupied Bandwidth, Frequency Error, Frequency Error (ppm), Modulation Type, and TSC measurement. Result Format See FETCh:PFail? It is a combination of the commands :ABORT; :INITiate; :FETCh:PVTSlot? The Power vs. Time (Slot) measurement must be the active measurement (specified by CONFigure:PVTSlot). The current measurement can be queried using CONFigure?

Data is returned as 9 comma-delimited values: Channel Power in dBm, Burst Power in dBm, Average Burst Power in dBm, Span in MHz, Occupied Bandwidth in MHz, Frequency Error in MHz, Frequency Error (ppm), Modulation Type, and TSC. "--" is returned for each data that is not valid at that instance.

Related Command: MEASure:PVTSlot? CONFigure:PVTSlot FETCh:PVTSlot?

Front Panel

Access: Shift-4 (Measure), Power vs. Time (Slot)

:READ:SPECTrum:MULTi?

Title: Read Multi-Channel Spectrum

Required Option: 40

Description: Triggers a new Multi-Channel Spectrum measurement and returns the results: Span. It is a combination of the commands :ABORT; :INITiate; :FETCh:SPECTrum:MULTi? The Multi-Channel Spectrum measurement must be the active measurement (specified by CONFigure:SPECTrum:MULTi). The current measurement can be queried using CONFigure?

Data is returned as 1 value: Span in MHz.

Default Unit: MHz

Front Panel

Access: Shift-4 (Measure), Spectrum, Multi-Channel Spectrum

:READ:SPECTrum:SINGLE?

Title: Read Single Channel Spectrum

Required Option: 40

Description: Triggers a new Single Channel Spectrum measurement and returns the results: Channel Power, Burst Power, Average Burst Power, Span, Occupied Bandwidth, Frequency Error, Frequency Error (ppm), Modulation Type, and TSC measurement. It is a combination of the commands :ABORT; :INITiate; :FETCh:SPECTrum:SINGLE? The Single Channel Spectrum measurement must be the active measurement (specified by CONFigure:SPECTrum:SINGLE). The current measurement can be queried using :CONFigure?

Data is returned as 9 comma-delimited values: Channel Power in dBm, Burst Power in dBm, Average Burst Power in dBm, Span in MHz, Occupied Bandwidth in MHz, Frequency Error in MHz, Frequency Error (ppm), Modulation Type, and TSC. "--" is returned for each data that is not valid at that instance.

Related Command: MEASure:SPECTrum:SINGLE?
:CONFigure:SPECTrum:SINGLE FETCh:SPECTrum:SINGLE?

Front Panel

Access: Shift-4 (Measure), Spectrum, Channel Spectrum

6-10 :TRACe Subsystem

This subsystem contains commands related to the transfer of trace data to and from the instrument.

:TRACe:PREamble? <trace type>

Title: Trace Header Transfer

Description: Returns trace header information for the specified trace. The <trace type> must be one of the following:

SINGLE | MULTI | PVTFrame | PVTSlot | DEMod

Data can be transferred to and from the 5 available display trace types. Use the commands in the MMEMory subsystem to store and recall traces from the instrument memory. The response begins with an ASCII header. The header specifies the number of following bytes. It looks like #AX, where A is the number of digits in X and X is the number of bytes that follow the header. Note that the instrument must be set in the selected view. Use the CONFIGure commands to set the unit to the selected view. Parameters are returned in comma-delimited ASCII format. Each parameter is returned as "NAME=VALUE[UNITS]," Valid parameters are shown in ["GSM Parameter Names" on page 2-22](#).

Parameter: <trace type>

Related Command: :TRACe:DATA?

:TRACe[:DATA]? <trace type>

Title: Trace Data Transfer

Description: This command transfers trace data from the instrument to the controller. The <trace type> must be one of the following:

SINGLE | MULTI | PVTFrame | PVTSlot | DEMod.

The format of the block data in the query form is specified by :FORMat:DATA. The block data in the command form is always sent in ASCII format. The response begins with an ASCII header that specifies the number of data bytes. It looks like #AX, where A is the number of digits in X and X is the number of bytes that follow the header. Each data point is separated by a comma delimiter. Trace setup information can be acquired using :TRACe[:DATA]:PREamble?.

Use the commands in the MMEMory subsystem to store and recall traces from the instrument memory. Except for DEMod, there is only one value per data point. For DEMod, each data point is represented by 2 values, 4 bytes each: IData (no units), and QData (no units). For SINGLE, MULTI, PVTFrame, and PVTSlot, the unit is in dBm. Note that the instrument must be set in the selected view. Use the CONFIGure commands to set the unit to the selected view.

Parameter: <trace type>

Related Command: :FORMat[:DATA]

:TRACe[:DATA]:PREamble?

6-11 [:SENSe] Subsystem

The commands in this subsystem relate to device-specific parameters, not signal-oriented parameters.

[:SENSe]:FREQuency:BAND AUTO|GSM|EDGE

[:SENSe]:FREQuency:BAND?

Title: GSM/EDGE Measurement Selection

Description: This command toggles the type of signal that is measured. AUTO allows the instrument to search for a GSM or EDGE signal automatically. GSM sets the instrument to measure only GSM signals. EDGE sets the instrument to measure only EDGE signals.

The query form of the command returns the measurement mode that the instrument is currently in.

Parameter: AUTO|GSM|EDGE

Parameter Type: <char>

Default Value: AUTO

Front Panel

Access: Setup, GSM/EDGE Select

[:SENSe]:FREQuency:CENTer <freq>

[:SENSe]:FREQuency:CENTer?

Title: Center Frequency

Description: Sets the center frequency. Note that changing the value of the center frequency will change the value of the coupled parameters Start Frequency and Stop Frequency. It may also change the value of the span.

Parameter: <freq>

Default Value: 1 GHz

Default Unit: Hz

Range: 0 Hz to 7.1 GHz

Front Panel

Access: Freq, Center Freq

[:SENSe]:FREQuency:SIGStandard:CHANnel <number>

[:SENSe]:FREQuency:SIGStandard:CHANnel?

Title: Channel Selection

Description: Sets the channel number for the selected signal standard.

Parameter: <number>

Front Panel

Access: Freq, Channel

[:SENSE]:FREQUENCY:SIGStandard:NAME <string>

[:SENSE]:FREQUENCY:SIGStandard:NAME?

Title: Signal Standard

Description: Selects the desired signal standard from the list. The <string> argument is the name of the desired signal standard as displayed in the instrument's current signal standard list. The list can be displayed on the instrument by choosing the Signal Standard submenu button in the Freq menu. The list can also be downloaded remotely and viewed using Anritsu Master Software Tools. For example, if the desired Signal Standard is P-GSM 900 - Uplink, then the value of the <string> argument would be "P-GSM 900 - Uplink".

The query form of this command will return the name of the currently selected Signal Standard on the list.

Parameter: <string>

Front Panel

Access: Freq, Signal Standard

[:SENSE]:FREQUENCY:START?

Title: Start Frequency

Description: Queries the start frequency of the Multi-Channel Spectrum. Note that this command is valid only if the current view is set to Multi-Channel Spectrum.

Parameter: <freq>

Default Unit: Hz

Related Command: [:SENSE]:FREQUENCY:STOP?

[:SENSE]:FREQUENCY:STOP?

Title: Stop Frequency

Description: Queries the stop frequency of the Multi-Channel Spectrum. Note that this command is valid only if the current view is set to Multi-Channel Spectrum.

Parameter: <freq>

Default Unit: Hz

[:SENSe]:PFail <test set>

[:SENSe]:PFail?

Title: PASS/FAIL Test Selection

Description: Selects the active test set to be used in subsequent PASS/FAIL measurements. The <test set> value must correspond to a test set that is defined in the test set list. To view the list on the instrument, go into the "Measurement" menu, press the "Pass/Fail Mode" key, and then press the "Select Pass/Fail Test" submenu. Alternatively, the list can be retrieved remotely and viewed using the Anritsu Master Software Tools. The <test set> argument is a 1-based index of the position of the desired Pass/Fail test set in the instrument's current Pass/Fail test set list. For example, if the desired Pass/Fail test is the 3rd item on the list, then the value of the <test set> argument would be 3.

When using the query form of the command, the return value is the currently selected test set number. If there is not a valid test set selected, the return value is "-1" (negative 1).

Parameter: <test set>

Related Command: :CONFigure:PFail

Front Panel

Access: Measurements, Pass/Fail Mode, Select Pass/Fail Test

[:SENSe]:POWer[:RF]:RANGe:AUTO OFF|ON|0|1

[:SENSe]:POWer[:RF]:RANGe:AUTO?

Title: Automatic Amplitude Range

Description: Sets the automatic amplitude range. Setting the value to ON or 1 will result in the amplitude range being coupled to the detected input signal level. Setting the value to OFF or 0 will result in the input attenuation being un-coupled from the input signal level. That is, changing the input signal level will not change the amplitude range. When this command is issued, the amplitude range itself will not change. The default value is ON. That is, sending :SENS:POW:RANG:AUTO is equivalent to sending :SENS:POW:RANG:AUTO ON.

Parameter: OFF|ON|0|1

Parameter Type: <boolean>

Default Value: ON

Related Command: [:SENSe]:POWer[:RF]:RANGe

Front Panel

Access: Amplitude, Auto Range

[:SENSE]:POWER[:RF]:RANGE[:IMMEDIATE]

Title: Amplitude Range

Description: Re-calculates amplitude range. Note that issuing this command will set the automatic dynamic range OFF.

Related Command: [:SENSE]:POWER[:RF]:RANGE:AUTO

Front Panel

Access: Amplitude, Adjust Range

[:SENSE]:PVTFrame:START?

Title: Power vs. Time (Frame) Start Time

Description: Queries the Power vs. Time (Frame) start time. Only valid in the Power vs. Time (Frame) measurement.

Default Unit: seconds

Related Command: [:SENSE]:PVTFrame:STOP?

[:SENSE]:PVTFrame:STOP?

Title: Power vs. Time (Frame) Stop Time

Description: Queries the Power vs. Time (Frame) stop time. Only valid in the Power vs. Time (Frame) measurement.

Default Unit: seconds

Related Command: [:SENSE]:PVTFrame:START?

[:SENSE]:PVTSLOT:START?

Title: Power vs. Time (Slot) Start Time

Description: Queries the Power vs. Time (Slot) start time. Only valid in the Power vs. Time (Slot) measurement.

Default Unit: seconds

Related Command: [:SENSE]:PVTSLOT:STOP?

[:SENSE]:PVTSLOT:STOP?

Title: Power vs. Time (Slot) Stop Time

Description: Queries the Power vs. Time (Slot) stop time. Only valid in the Power vs. Time (Slot) measurement.

Default Unit: seconds

Related Command: [:SENSE]:PVTSLOT:START?

Chapter 7 — WCDMA Commands

7-1 :ABORt Subsystem

The abort subsystem includes commands that allow the user to stop current measurement activities on the instrument.

:ABORt

Title: Abort

Description: Restarts the current sweep and/or measurement. Resets the trigger system. If :INITiate:CONTinuous is OFF (i.e. the instrument is in single sweep mode), send the command :INITiate[:IMMediate] to trigger the next sweep. If :INITiate:CONTinuous is ON (i.e. the instrument is in continuous sweep mode), a new sweep will start immediately.

Parameter: NA

Related Command: :INITiate:CONTinuous
:INITiate[:IMMediate]

7-2 :CALCulate Subsystem

The commands in this subsystem process data that has been collected via the SENSE subsystem.

:CALCulate:MARKer:AOff

Title: Turn All Markers Off

Description: Turns off all markers.

Front Panel

Access: Marker, All Markers Off

:CALCulate:MARKer{1|2|3|4|5|6}:X <x-parameter>

:CALCulate:MARKer{1|2|3|4|5|6}:X?

Title: Marker X Value

Description: Sets the location of the marker on the x-axis at the specified location. <x-parameter> is defined in the current x-axis units. The query version of the command returns the location of the marker on the x-axis. Note that the marker is snapped to the data point closest to the specified value. If the specified marker is not on it is set to on.

Parameter: <x-parameter>

Default Unit: Current x-axis unit

Example: To set reference marker #2 to 1 GHz on the x-axis:

```
:CALCulate:MARKer2:X 1
```

```
:CALCulate:MARKer2:X 1GHz
```

To set reference marker #1 to 1.5 GHz on the x-axis:

```
:CALCulate:MARKer:X 1.5GHz
```

```
:CALCulate:MARKer1:X 1.5GHz
```

Front Panel

Access: Marker, Marker [1/2/3/4/5/6]

:CALCulate:MARKer{1|2|3|4|5|6}:Y?

Title: Marker Read Y Value

Description: Reads the current Y value for the specified marker. The units are the units of the y-axis.

Default Unit: Current y-axis unit

:CALCulate:MARKer{1|2|3|4|5|6}[:STATe] OFF|ON|0|1

:CALCulate:MARKer{1|2|3|4|5|6}[:STATe]?

Title: Marker State

Description: Sets the specified marker on/off.

Parameter: OFF|ON|0|1

Parameter Type: <boolean>

Default Value: OFF

Example: To turn off reference marker #1:

`:CALCulate:MARKer1:STATe OFF`

Front Panel

Access: Marker, On/Off

7-3 :CONFigure Subsystem

This set of commands prepares the instrument for the selected measurement. It disables any currently-enabled measurements and activates the specified measurement. It sets the instrument to single sweep mode, waiting for an :INITiate command. It will not initiate the taking of a measurement.

Current instrument settings may be changed to default values. These changes are identified with their respective measurement commands.

:CONFigure SUMMary|PFail

Title: Configure Summary Measurement

Description: This command configures the UMTS Summary or PASS/FAIL measurement. It disables any other active measurements. None of the instrument parameters are changed by the execution of this command. Sets the instrument to single sweep mode (:INITiate:CONTInuous OFF). Measurement settings can be modified by using the [:SENSE] commands before initiating a measurement. In SUMMARY mode, the measurement results are equivalent to the results that are displayed by choosing Measurements, then WCDMA Summary from the front panel. In PFail mode, the results are equivalent to those that are displayed by choosing Measurements, then Pass Fail Mode from the front panel. This set of commands returns the most recent measurement data of the active measurement. They will not switch to another measurement. To get new measurement data, use the READ command.

Parameter: SUMMARY | PFail

Parameter Type: <char>

:CONFigure:DEMod <char>

Title: Configure Demodulation Measurement

Required Option: 65

Description: Valid <char> parameter options:
SUMMary | CDPower | CODogram | HSDPa

The HSDPA measurement is only available if option 65 is installed. This command configures the selected demodulation measurement. It disables any other active measurements. None of the instrument parameters are changed by the execution of this command. Sets the instrument to single sweep mode (:INITiate:CONTInuous OFF). Measurement settings can be modified by using the [:SENSE]:DEMod commands before initiating a measurement.

When the SUMMARY option is selected, the measurement results are equivalent to the results that are displayed by choosing Measurements, then Demod, then Summary from the front panel. When the CDP option is selected, the measurement results are equivalent to the results that are displayed by choosing Measurements, then Demod, then CDP from the front panel. When the CODOGRAM option is selected, the measurement results are equivalent to the results that are displayed by choosing Measurements, then Demod, then Codogram from the front panel. When the HSDPa option is selected, the measurement results are equivalent to the results that are displayed by choosing Measurements, then Demod, then HSDPA from the front panel.

Parameter: <char>

Related Command: [:SENSE]:DEMod:SCODE
[:SENSE]:DEMod:SFACTOR
[:SENSE]:DEMod:THRShold
[:SENSE]:DEMod:PICH:CODE
[:SENSE]:DEMod:SCCPch:CODE

Front Panel

Access: Measurements, Demodulator

:CONFigure:OTA

Title: Configure Over-The-Air Measurement

Description: This command configures the over-the-air measurement. It disables any other active measurements. None of the instrument parameters are changed by the execution of this command. Sets the instrument to single sweep mode (:INITiate:CONTinuous OFF). Measurement settings can be modified by using the [:SENSE]:OTA commands before initiating a measurement. The measurement results are equivalent to the results that are displayed by choosing Measurements, then OTA from the front panel.

Related Command: [:SENSE]:OTA:RESet
[:SENSE]:OTA:SCODE
[:SENSE]:OTA:SORT

:CONFigure:RF <char>

Title: Configure RF Measurement

Description: Valid parameter options:
SUMMary | SPECTrum | ACLR | EMISSion | BANDSpectrum

This command configures the selected RF measurement. It disables any other active measurements. None of the instrument parameters are changed by the execution of this command. Sets the instrument to single sweep mode (:INITiate:CONTinuous OFF). Measurement settings can be modified by using the [:SENSE]:RF commands before initiating a measurement.

When the SUMMary option is selected, the measurement results are equivalent to the results that are displayed by choosing Measurements, then RF, then Summary from the front panel. When the SPECTrum option is selected, the measurement results are equivalent to the results that are displayed by choosing Measurements, then RF, then Channel Spectrum from the front panel. When the ACLR option is selected, the measurement results are equivalent to the results that are displayed by choosing Measurements, then RF, then ACLR from the front panel. When the EMISsion option is selected, the measurement results are equivalent to the results that are displayed by choosing Measurements, then RF, then Spectral Emission Mask from the front panel. When the BANDspectrum option is selected, the measurement results are equivalent to the results that are displayed by choosing Measurements, then RF Measurements, then Band Spectrum from the front panel.

Parameter: <char>

Related Command: [:SENSe]:FREQuency
[:SENSe]:RF:ACLR:MAINchannelcount
[:SENSe]:RF:ACLR:ADJCchannelcount

7-4 :DISPlay Subsystem

This subsystem provides commands that modify the display of data for the user. They do not modify the way in which data are returned to the controller.

:DISPlay:WINDow:TRACe:Y[:SCALE]:OFFSet <rel ampl>

:DISPlay:WINDow:TRACe:Y[:SCALE]:OFFSet?

Title: Power Offset

Description: Sets the power offset value for the y-axis.

Parameter: <rel ampl>

Default Value: 0 dB

Default Unit: dB

Range: 0 dB to 100 dB

Front Panel

Access: Amplitude, Power Offset

:DISPlay:WINDow:TRACe:Y[:SCALE]:PDIVision <rel ampl>

:DISPlay:WINDow:TRACe:Y[:SCALE]:PDIVision?

Title: Scale

Description: Sets the scale (dB/division) for the y-axis.

Parameter: <rel ampl>

Default Value: 10 dB/div

Default Unit: dB

Range: 1 dB to 15 dB

Front Panel

Access: Amplitude, Scale

7-5 :FETCh Subsystem

This set of commands returns the most recent measurement data of the active measurement. They will not switch to another measurement.

To make a new measurement, use the INITiate command. To get new measurement data, use the READ or MEASure query commands.

:FETCh:ACLR?

Title: Fetch Adjacent Channel Leakage Ratio

Description: Returns the most recent adjacent channel leakage ratio measurement results. If the instrument is sweeping, it will not return until the sweep is complete. If the instrument is not sweeping and the current data is not valid it will return error -230. This could occur if there was a *RST immediately before the :FETCh? or if a measurement parameter was changed without an :INITiate.

Data is returned as 12 comma-separated values: -20 MHz channel power, -15 MHz channel power, -10 MHz channel power, -5 MHz channel power, Main channel power 1, Main channel power 2, Main channel power 3, Main channel power 4, +5 MHz channel power, +10 MHz channel power, +15 MHz channel power, +20 MHz channel power.

Default Unit: dBm

:FETCh:CHPower?

Title: Fetch Channel Power/Density

Description: Returns the most recent channel power measurement results. If the instrument is sweeping, it will not return until the sweep is complete. If the instrument is not sweeping and the current data is not valid it will return error -230. This could occur if there was a *RST immediately before the :FETCh? or if a measurement parameter was changed without an :INITiate.

Default Unit: dBm

Related Command: :FETCh:CHPower:CHPower?
:FETCh:CHPower:DENSity?

:FETCh:DEMod:ACTChannels?

Title: Fetch Active Channel Count

Description: Returns the active channel count from the most recent measurement results. If the instrument is sweeping, it will not return until the sweep is complete. If the instrument is not sweeping and the current data is not valid it will return error -230. This could occur if there was a *RST immediately before the :FETCh? or if a measurement parameter was changed without an :INITiate.

Data is returned as a single value representing the total number of active channels.

Default Unit: No Units

:FETCh:DEMod:CDPower?

Title: Fetch Demodulated Channel Power

Description: Returns the most recent absolute power measurement results for the requested logical channel. If the instrument is sweeping, it will not return until the sweep is complete. If the instrument is not sweeping and the current data is not valid it will return error -230. This could occur if there was a *RST immediately before the :FETCh? or if a measurement parameter was changed without an :INITiate.

Data is returned as 4 comma-delimited values: CPICH power, PCCPCH power, PICH power, SCCPCH power.

Default Unit: dBm

Related Command: :CONFigure:DEMod CDPower
:MEASure:DEMod:CDPower?
:READ:DEMod:CDPower?

Front Panel

Access: Measurements, Demodulator, CDP

:FETCh:DEMod:CFTHrough?

Title: Fetch Carrier Feed Through

Description: Returns the most recent carrier feed through measurement results. If the instrument is sweeping, it will not return until the sweep is complete. If the instrument is not sweeping and the current data is not valid it will return error -230. This could occur if there was a *RST immediately before the :FETCh? or if a measurement parameter was changed without an :INITiate.

Data is returned as a single value representing the carrier feed through.

Default Unit: dB

:FETCh:DEMod:EVM?

Title: Fetch Error Vector Magnitude (EVM)

Description: Returns the most recent EVM measurement result. If the instrument is sweeping, it will not return until the sweep is complete. If the instrument is not sweeping and the current data is not valid it will return error -230. This could occur if there was a *RST immediately before the :FETCh? or if a measurement parameter was changed without an :INITiate.

Data is returned as a single value representing the RMS error vector magnitude

Default Unit: %

:FETCh:DEMod:FERRor:PPM?

Title: Fetch Frequency Error PPM

Description: Returns the most recent frequency error PPM measurement result. If the instrument is sweeping, it will not return until the sweep is complete. If the instrument is not sweeping and the current data is not valid it will return error -230. This could occur if there was a *RST immediately before the :FETCh? or if a measurement parameter was changed without an :INITiate.

Data is returned as a single value representing the frequency error PPM.

Default Unit: No units

Related Command: MEASure:DEMod:FERRor:PPM?
READ:DEMod:FERRor:PPM?

:FETCh:DEMod:FERRor:PRECise?

Title: Fetch Frequency Error

Description: Returns the most recent frequency error measurement result. If the instrument is sweeping, it will not return until the sweep is complete. If the instrument is not sweeping and the current data is not valid it will return error -230. This could occur if there was a *RST immediately before the :FETCh? or if a measurement parameter was changed without an :INITiate.

Data is returned as a single value representing the frequency error. Note that this command is the same as :FETCh:DEMod:FERRor?, but returns the result with a precision of one-tenth Hertz.

Default Unit: Hertz

:FETCh:DEMod:FERRor?

Title: Fetch Frequency Error

Description: Returns the most recent frequency error measurement result. If the instrument is sweeping, it will not return until the sweep is complete. If the instrument is not sweeping and the current data is not valid it will return error -230. This could occur if there was a *RST immediately before the :FETCh? or if a measurement parameter was changed without an :INITiate.

Data is returned as a single value representing the frequency error.

Default Unit: Hertz

: FETCh : DEMod : HSDPa : FERRor : PPM?

Title: Fetch HSDPA Frequency Error PPM

Description: Returns the most recent HSDPA frequency error PPM measurement result. If the instrument is sweeping, it will not return until the sweep is complete. If the instrument is not sweeping and the current data is not valid it will return error -230. This could occur if there was a *RST immediately before the :FETCh? or if a measurement parameter was changed without an :INITiate.

Data is returned as a single value representing the HSDPA frequency error PPM.

Default Unit: No units

Related Command: MEASure : DEMod : HSDPa : FERRor : PPM?
READ : DEMod : HSDPa : FERRor : PPM?

: FETCh : DEMod : HSDPa : FERRor?

Title: Fetch HSDPA Frequency Error

Description: Returns the most recent HSDPA frequency error measurement result. If the instrument is sweeping, it will not return until the sweep is complete. If the instrument is not sweeping and the current data is not valid it will return error -230. This could occur if there was a *RST immediately before the :FETCh? or if a measurement parameter was changed without an :INITiate.

Data is returned as a single value representing the HSDPA frequency error.

Default Unit: Hertz

: FETCh : DEMod : HSDPa : TXFRequency?

Title: Fetch HSDPA Transmitter Frequency

Description: Returns the most recent HSDPA transmitter frequency measurement results. If the instrument is sweeping, it will not return until the sweep is complete. If the instrument is not sweeping and the current data is not valid it will return error -230. This could occur if there was a *RST immediately before the :FETCh? or if a measurement parameter was changed without an :INITiate.

Data is returned as a single value representing the HSDPA carrier frequency.

Default Unit: Hertz

Related Command: :MEASure : DEMod : HSDPa : TXFRequency?
:READ : DEMod : HSDPa : TXFRequency?

:FETCh:DEMod:NFLoor?

Title: Fetch Code Domain Noise Floor

Description: Returns the most recent code domain noise floor measurement result. If the instrument is sweeping, it will not return until the sweep is complete. If the instrument is not sweeping and the current data is not valid it will return error -230. This could occur if there was a *RST immediately before the :FETCh? or if a measurement parameter was changed without an :INITiate.

Data is returned as a single value representing the noise floor power level.

Default Unit: dB

:FETCh:DEMod:NUMChannels?

Title: Fetch Total Channel Count

Description: Returns the total channel count from the most recent measurement results. If the instrument is sweeping, it will not return until the sweep is complete. If the instrument is not sweeping and the current data is not valid it will return error -230. This could occur if there was a *RST immediately before the :FETCh? or if a measurement parameter was changed without an :INITiate.

Data is returned as a single value representing the total number of channels.

Default Unit: No units

:FETCh:DEMod:SPOWER?

Title: Fetch Synch Channel Power

Description: Returns the most recent absolute power measurement results for the requested synch channel. If the instrument is sweeping, it will not return until the sweep is complete. If the instrument is not sweeping and the current data is not valid it will return error -230. This could occur if there was a *RST immediately before the :FETCh? or if a measurement parameter was changed without an :INITiate.

Data is returned as 3 comma-delimited values: SCH power, PSCH power, SSCH power.

Default Unit: dBm

:FETCh:DEMod:TXFrequency:PRECise?

Title: Fetch Transmitter Frequency

Description: Returns the most recent transmitter frequency measurement results. If the instrument is sweeping, it will not return until the sweep is complete. If the instrument is not sweeping and the current data is not valid it will return error -230. This could occur if there was a *RST immediately before the :FETCh? or if a measurement parameter was changed without an :INITiate.

Data is returned as a single value representing the carrier frequency. Note that this command is the same as :FETCh:DEMod:TXFrequency?, but returns the result with a precision of one-tenth Hertz.

Default Unit: Hertz

:FETCh:DEMod:TXFrequency?

Title: Fetch Transmitter Frequency

Description: Returns the most recent transmitter frequency measurement results. If the instrument is sweeping, it will not return until the sweep is complete. If the instrument is not sweeping and the current data is not valid it will return error -230. This could occur if there was a *RST immediately before the :FETCh? or if a measurement parameter was changed without an :INITiate.

Data is returned as a single value representing the carrier frequency.

Default Unit: Hertz

:FETCh:EMISsion:FAIL?

Title: Fetch Spectral Emission Mask Pass/Fail

Description: Returns the most recent spectral emission mask pass/fail measurement result. Any violation of the spectral emission mask template will cause a FAIL result. If the instrument is sweeping, it will not return until the sweep is complete. If the instrument is not sweeping and the current data is not valid it will return error -230. This could occur if there was a *RST immediately before the :FETCh? or if a measurement parameter was changed without an :INITiate.

Data is returned as a single value indicating the PASS/FAIL status of the spectral emission mask measurement (PASS = 0, FAIL = 1).

Default Unit: No units

:FETCh:EMISsion:TEMPlate:DATA?

Title: Fetch Spectral Emission Mask Template Data

Description: Returns the spectral emission mask template power level, frequency, and PASS/FAIL data for all ten frequency ranges shown in the Spectral Emission Summary. If the instrument is sweeping, it will not return until the sweep is complete. If the instrument is not sweeping and the current data is not valid it will return error -230. This could occur if there was a *RST immediately before the :FETCh? or if a measurement parameter was changed without an :INITiate. Any violation of the spectral emission mask template will cause a FAIL result.

For each frequency range, the data is returned as 3 comma delimited values: Power Level in dBm, Frequency in Hz, and PASS/FAIL. The order in which the data is returned is shown below (from top to bottom).

Range: -12.5 MHz to -8 MHz
 -8 MHz to -4 MHz
 -4 MHz to -3.515 MHz
 -3.515 MHz to -2.715 MHz
 -2.715 MHz to -2.515 MHz
 2.515 MHz to 2.715 MHz
 2.715 MHz to 3.515 MHz
 3.515 MHz to 4 MHz
 4 MHz to 8 MHz
 8 MHz to 12.5 MHz

Related Command: MEASure:EMISsion:TEMPlate:DATA?
 READ:EMISsion:TEMPlate:DATA?

:FETCh:EMISsion:TEMPlate?

Title: Fetch Spectral Emission Mask Template

Description: Returns the spectral emission mask template used for the most recent spectral emission mask measurement. Any violation of the spectral emission mask template will cause a FAIL result. If the instrument is sweeping, it will not return until the sweep is complete. If the instrument is not sweeping and the current data is not valid it will return error -230. This could occur if there was a *RST immediately before the :FETCh? or if a measurement parameter was changed without an :INITiate.

Data is returned as a single value representing the template used for the current spectral emission mask measurement results.

Templates:

Template 0: Power \geq 43 dBm
 Template 1: 43 dBm > Power \geq 39 dBm
 Template 2: 39 dBm > Power \geq 31 dBm
 Template 3: Power < 31 dBm

Default Unit: No units

:FETCh:EMISsion?

Title: Fetch Spectral Emission Mask Results

Description: Returns the most recent spectral emission mask pass/fail and template measurement results. Any violation of the spectral emission mask template will cause a FAIL result. If the instrument is sweeping, it will not return until the sweep is complete. If the instrument is not sweeping and the current data is not valid it will return error -230. This could occur if there was a *RST immediately before the :FETCh? or if a measurement parameter was changed without an :INITiate.

Data is returned as 2 comma-delimited values: PASS/FAIL status (PASS = 0, FAIL = 1), template number. See :FETCh:EMISsion:TEMPlate command for valid template numbers.

Default Unit: No units

Related Command: :FETCh:EMISsion:FAIL?
:FETCh:EMISsion:TEMPlate?

:FETCh:OBWidth?

Title: Fetch Occupied Bandwidth

Description: Returns the most recent occupied bandwidth measurement results. If the instrument is sweeping, it will not return until the sweep is complete. If the instrument is not sweeping and the current data is not valid it will return error -230. This could occur if there was a *RST immediately before the :FETCh? or if a measurement parameter was changed without an :INITiate.

Default Unit: Hz

:FETCh:OTA{1|2|3|4|5|6}?

Title: Fetch Over The Air

Description: Returns the most recent over-the-air measurement results. If the instrument is sweeping, it will not return until the sweep is complete. If the instrument is not sweeping and the current data is not valid it will return error -230. This could occur if there was a *RST immediately before the :FETCh? or if a measurement parameter was changed without an :INITiate.

The measurement results are returned as 5 comma delimited values: scrambling code, CPICH power, chip energy, Ec/I0 ratio, pilot dominance. If valid results are not available in the requested position (1-6), the returned string will contain a series of 3 dashes "---" instead of the numeric results.

Default Unit: Scrambling Code: No units
CPICH power: dBm
EC/I0: dB
Chip Energy: dBm
Pilot dominance: No units

:FETCh:PFail?

Title: Fetch PASS/FAIL

Description: Returns the most recent PASS/FAIL measurement results. If the instrument is actively measuring, it will not return until the measurement is complete. If the instrument is not actively measuring and the current data is not valid it will return error -230. This could occur if there was a *RST immediately before the :FETCh? or if a measurement parameter was changed without an :INITiate. Measurement results are returned in a block of ASCII text in the format of <header><block>. The ASCII header specifies the number of data bytes. It looks like #AX, where A is the number of digits in X and X is the number of bytes in the <block>. The block consists of a set of records which indicate individual test results. Records are comma-separated. Each record follows the format <test ID>: <input1> <input2> <min> <max> <value1> <value2> <PASS/FAIL/OPTION NOT INSTALLED>. The <test ID> field indicates which test was performed to retrieve these results. The <input1> and <input2> fields indicate the test setup. The <min> and <max> fields indicate the minimum and maximum values against which <value1> and <value2> were compared to arrive at the final PASS/FAIL result. If the specified test is not available in the instrument, the <PASS/FAIL> field will indicate “option not available” instead of “pass” or “fail”. All unused fields for a given test are represented by a double dash (“--”).

Related Command: MEASure:PFail?
:CONFigure PFail
READ:PFail?

:FETCh:PTAPower?

Title: Fetch Peak to Average Power Ratio

Description: Returns the most recent peak to average power ratio measurement result. If the instrument is sweeping, it will not return until the sweep is complete. If the instrument is not sweeping and the current data is not valid it will return error -230. This could occur if there was a *RST immediately before the :FETCh? or if a measurement parameter was changed without an :INITiate.

Default Unit: dB

7-6 :FORMat Subsystem

This subsystem contains commands that determine the formatting of numeric data when it is transferred.

The format setting affects data in specific commands only. If a command is affected, it is noted in the command description.

:FORMat[:READings][:DATA] ASCii|INTeger,32|REAL,32

:FORMat[:READings][:DATA]?

Title: Numeric Data Format

Description: This command specifies the format in which data is returned in certain commands.

ASCii format returns the data in comma-separated ASCII format. The units are the current instrument units. This format requires many more bytes so it is the slowest format. INTeger 32 values are signed 32-bit integers in little-endian byte order. This format returns the data in 4-byte blocks.

The units are always mdBm. For example, if the measured result was -12.345 dBm, that value would be sent as -12345.) REAL,32 values are 32-bit floating point numbers conforming to the IEEE 754 standard in little-endian byte order. This format returns the data in 4-byte binary format. The units are the current instrument units.

Both INTeger,32 and REAL,32 formats return a definite block length. Each transfer begins with an ASCII header such as #42204. The first digit represents the number of following digits in the header (in this example, 4). The remainder of the header indicates the number of bytes that follow the header (in this example, 2204). You then divide the number of following bytes by the number of bytes in the data format you've chosen (4 for both INTeger,32 and REAL,32) to get the number of data points (in this example, 551).

Parameter: ASCii|INTeger,32|REAL,32

Parameter Type: <char>

Default Value: ASCii

Related Command: :TRACe[:DATA]

7-7 :INITiate Subsystem

This subsystem controls the triggering of measurements.

:INITiate:CONTInuous OFF|ON|0|1

:INITiate:CONTInuous?

Title: Continuous/Single Sweep

Description: Specifies whether the sweep/measurement is triggered continuously. If the value is set to ON or 1, another sweep/measurement is triggered as soon as the current one completes. If continuous is set to OFF or 0, the instrument enters the “idle” state and waits for the :INITiate[:IMMEDIATE] command or for :INITiate:CONTInuous ON. The default value is ON. That is, sending :INIT:CONT is equivalent to sending :INIT:CONT ON. The query version of the command returns a 1 if the instrument is continuously sweeping/measuring and returns a 0 if the instrument is in single sweep/measurement mode. Note that rapid toggling between ON and OFF is not allowed. The instrument must be allowed to make a full sweep before toggling can be done.

Parameter: OFF|ON|0|1

Parameter Type: <boolean>

Default Value: ON

Related Command: :INITiate[:IMMEDIATE]

Front Panel

Access: Shift-3 (Sweep), Sweep

:INITiate[:IMMEDIATE]

Title: Trigger Sweep/Measurement

Description: Initiates a sweep/measurement. If :INITiate:CONTInuous is set to ON, this command is ignored. Use this command in combination with :STATus:OPERation? to synchronize the capture of one complete set of data. When this command is sent, the “sweep complete” bit of :STATus:OPERation? is set to 0, indicating that the measurement has not completed. The data collection is then triggered. The controlling program can poll :STATus:OPERation? to determine the status. When the “sweep complete” bit is set to 1, data is ready to be retrieved.

Related Command: :INITiate:CONTInuous
:STATus:OPERation?

Front Panel

Access: Shift-3 (Sweep), Trigger Sweep

7-8 :MEASure Subsystem

These commands take the instrument from its current state, enable the specified measurement and put the instrument into single sweep mode. They correct any parameters that are invalid given the new measurement state such that a valid measurement can take place. Other settings may be changed; see the documentation of CONFigure for each measurement. They then initiate the measurement. When the measurement is complete, they return the result.

To make a measurement with settings other than the “default” measurement settings applied by CONFigure, do the following:

- Send the appropriate CONFigure command to set the desired measurement.
- Modify the settings as required.
- Send the appropriate READ command to measure and return the result.

To get the current measurement data, use the appropriate FETCh command.

:MEASure:ACLR?

Title: Measure Adjacent Channel Leakage Ratio

Description: Sets the active measurement to adjacent channel power ratio, sets the default measurement parameters, triggers a new measurement and returns the main channel(s) power, and adjacent channel(s) power. It is a combination of the commands :CONFigure:RF ACLR and :READ:ACLR? For a description of the default adjacent channel power ratio measurement parameters, see :CONFigure:RF ACLR. To make an adjacent channel power ratio measurement with settings other than the default values, send:

```
:CONFigure:RF ACLR
Commands to set desired settings
:READ:ACLR?
```

Data is returned as 12 comma-separated values: -20 MHz channel power, -15 MHz channel power, -10 MHz channel power, -5 MHz channel power, Main channel power 1, Main channel power 2, Main channel power 3, Main channel power 4, +5 MHz channel power, +10 MHz channel power, +15 MHz channel power, +20 MHz channel power.

Default Unit: dBm

:MEASure:CHPower?

Title: Measure Channel Power

Description: Sets the active measurement to Code Domain Power (CDP), sets the default measurement parameters, triggers a new measurement and returns the channel power results. It is a combination of the commands :CONFigure:DEMod CDPower and :READ:CHPower? For a description of the default channel power measurement parameters, see :CONFigure:DEMod CDPower. To make a channel power measurement with settings other than the default values, send:

:CONFigure:DEMOd CDPower
 Commands to set desired settings
 :READ:CHPower?

Default Unit: dBm

Related Command: :CONFigure:DEMod CDPower

:MEASure:DEMod:ACTChannels?

Title: Measure Active Code Domain Channels

Description: Sets the active measurement to code domain power, sets the default measurement parameters, triggers a new measurement and returns the number of active traffic channels. It is a combination of the commands :CONFigure:DEMod CDP and :READ:DEMod:ACTChannels? For a description of the default code domain power measurement parameters, see :CONFigure:DEMod CDP.

Related Command: :CONFigure:RF ACLR
 :CONFigure:DEMod:CDP

:MEASure:DEMod:CDPower?

Title: Measure Code Domain Power

Description: Sets the active measurement to code domain power, sets the default measurement parameters, triggers a new measurement and returns the channel power results. It is a combination of the commands :CONFigure:DEMod CDPower and :READ:DEMod:CDPower? For a description of the default channel power measurement parameters, see :CONFigure:DEMod CDPower. To make a code domain power measurement with settings other than the default values, send:

:CONFigure:DEMod CDP
 Commands to set desired settings
 :READ:DEMod:CDPower?

Results are returned as 4 comma-delimited values: CPICH power, PCCPCH power, PICH power, SCCPCH power.

Default Unit: dBm

Related Command: :CONFigure:DEMod CDPower
 :READ:DEMod:CDPower?
 FETCh:DEMod:CDPower?

:MEASure:DEMod:CFThrougH?

Title: Measure Carrier Feed Through

Description: Sets the active measurement to code domain power, sets the default measurement parameters, triggers a new measurement and returns the carrier feed through results. It is a combination of the commands :CONFigure:DEMod CDP and :READ:DEMod:CFThrougH?. For a description of the default code domain power measurement parameters, see :CONFigure:DEMod CDP. To make a carrier feed through measurement with settings other than the default values, send:

:CONFigure:DEMod CDP
Commands to set desired settings
:READ:DEMod:CFThrougH?

Default Unit: dB

Related Command: :CONFigure:DEMod CDP

:MEASure:DEMod:EVM?

Title: Measure Error Vector Magnitude

Description: Sets the active measurement to code domain power, sets the default measurement parameters, triggers a new measurement and returns the EVM results. It is a combination of the commands :CONFigure:DEMod CDP and :READ:DEMod:EVM?. For a description of the default code domain power measurement parameters, see :CONFigure:DEMod CDP. To make a carrier feed through measurement with settings other than the default values, send:

:CONFigure:DEMod CDP
Commands to set desired settings
:READ:DEMod:EVM?

Default Unit: %

Related Command: :CONFigure:DEMod CDP

:MEASure:DEMod:FERRor:PPM?

Title: Measure Frequency Error PPM

Description: Sets the active measurement to code domain power, sets the default measurement parameters, triggers a new measurement and returns the frequency error PPM results. It is a combination of the commands :CONFigure:DEMod CDP and :READ:DEMod:FERRor:PPM?. For a description of the default code domain power measurement parameters, see :CONFigure:DEMod CDP. To make a frequency error measurement with settings other than the default values, send:

:CONFigure:DEMod CDP
 Commands to set desired settings
 :READ:DEMod:FERRor:PPM?

Related Command: :READ:DEMod:FERRor:PPM?
 :FETCh:DEMod:FERRor:PPM?
 :CONFigure:DEMod:CDP

:MEASure:DEMod:FERRor:PRECise?

Title: Measure Frequency Error

Description: Sets the active measurement to code domain power, sets the default measurement parameters, triggers a new measurement and returns the frequency error results. It is a combination of the commands :CONFigure:DEMod CDP and :READ:DEMod:FERRor:PRECise? For a description of the default code domain power measurement parameters, see :CONFigure:DEMod CDP. To make a frequency error measurement with settings other than the default values, send:

:CONFigure:DEMod CDP
 Commands to set desired settings
 :READ:DEMod:FERRor:PRECise?

Note that this command is the same as :MEASure:DEMod:FERRor?, but returns the result with a precision of one-tenth Hertz.

Default Unit: Hz

Related Command: :CONFigure:DEMod CDP
 :MEASure:DEMod:FERRor?

:MEASure:DEMod:FERRor?

Title: Measure Frequency Error

Description: Sets the active measurement to code domain power, sets the default measurement parameters, triggers a new measurement and returns the frequency error results. It is a combination of the commands :CONFigure:DEMod CDP and :READ:DEMod:FERRor? For a description of the default code domain power measurement parameters, see :CONFigure:DEMod CDP. To make a frequency error measurement with settings other than the default values, send:

:CONFigure:DEMod CDP
 Commands to set desired settings
 :READ:DEMod:FERRor?

Default Unit: Hz

Related Command: :CONFigure:DEMod CDP

:MEASure:DEMod:HSDPa:FERRor:PPM?

Title: Measure HSDPA Frequency Error PPM

Description: Sets the active measurement to HSDPA sets the default measurement parameters, triggers a new measurement and returns the HSDPA frequency error PPM results. It is a combination of the commands :CONFigure:DEMod HSDPa and :READ:DEMod:HSDPa:FERRor:PPM? For a description of the default HSDPA measurement parameters, see :CONFigure:DEMod HSDPa. To make a frequency error measurement with settings other than the default values, send:

```
:CONFigure:DEMod HSDPa
Commands to set desired settings
:READ:DEMod:HSDPa:FERRor:PPM?
```

Related Command: :READ:DEMod:HSDPa:FERRor:PPM?
:FETCh:DEMod:HSDPa:FERRor:PPM?
:CONFigure:DEMod HSDPa

:MEASure:DEMod:HSDPa:FERRor?

Title: Measure HSDPA Frequency Error

Description: Sets the active measurement to HSDPA, sets the default measurement parameters, triggers a new measurement and returns the HSDPA frequency error results. It is a combination of the commands :CONFigure:DEMod HSDPa and :READ:DEMod:HSDPa:FERRor? For a description of the default HSDPA measurement parameters, see :CONFigure:DEMod HSDPa. To make a frequency error measurement with settings other than the default values, send:

```
:CONFigure:DEMod HSDPa
Commands to set desired settings
:READ:DEMod:HSDPa:FERRor?
```

Default Unit: Hz

Related Command: :READ:DEMod:HSDPa:FERRor?
:FETCh:DEMod:HSDPa:FERRor?
:CONFigure:DEMod HSDPa

:MEASure:DEMod:HSDPa:TXFRequency?

Title: Measure HSDPA Transmitter Frequency

Description: Sets the active measurement to HSDPA, sets the default measurement parameters, triggers a new measurement and returns the HSDPA transmitter frequency results. It is a combination of the commands :CONFigure:DEMod HSDPa and :READ:DEMod:HSDPa:TXFRequency? For a description of the default HSDPA measurement parameters, see :CONFigure:DEMod HSDPa. To make a transmitter frequency measurement with settings other than the default values, send:

:CONFigure:DEMod HSDPa
 Commands to set desired settings
 :READ:DEMod:HSDPa:TXFRequency?

Default Unit: Hz

Related Command: :READ:DEMod:HSDPa:TXFRequency?
 :FETCh:DEMod:HSDPa:TXFRequency?
 :CONFigure:DEMod:HSDPa

:MEASure:DEMod:NFLoor?

Title: Measure Code Domain Noise Floor

Description: Sets the active measurement to code domain power, sets the default measurement parameters, triggers a new measurement and returns the noise floor results. It is a combination of the commands :CONFigure:DEMod CDP and :READ:DEMod:NFLoor? For a description of the default code domain power measurement parameters, see :CONFigure:DEMod CDP. To make a noise floor measurement with settings other than the default values, send:

:CONFigure:DEMod HSDPa
 Commands to set desired settings
 :READ:DEMod:NFLoor?

Default Unit: dB

Related Command: :CONFigure:DEMod CDP

:MEASure:DEMod:NUMChannels?

Title: Measure Code Domain Channel Count

Description: Sets the active measurement to code domain power, sets the default measurement parameters, triggers a new measurement and returns the number of channels. It is a combination of the commands :CONFigure:DEMod CDP and :READ:DEMod:NUMChannels? For a description of the default code domain power measurement parameters, see :CONFigure:DEMod CDP. To make a channel count measurement with settings other than the default values, send:

:CONFigure:DEMod HSDPa
 Commands to set desired settings
 :READ:DEMod:NUMChannels?

Default Unit: dB

Related Command: :CONFigure:DEMod CDP

:MEASure:DEMod:SPOWer?

Title: Measure Synch Channel Power

Description: Sets the active measurement to code domain power, sets the default measurement parameters, triggers a new measurement and returns the synch channel power results. It is a combination of the commands :CONFigure:DEMod CDP and :READ:DEMod:SPOWer?. For a description of the default code domain power measurement parameters, see :CONFigure:DEMod CDP. To make a synch channel power measurement with settings other than the default values, send:

:CONFigure:DEMod CDP

Commands to set desired settings

:READ:DEMod:SPOWer?

Results are returned as 3 comma-delimited values: SCH power, PSCH power, SSCH power.

Default Unit: dBm

Related Command: :CONFigure:DEMod CDP

:MEASure:DEMod:TXFRrequency:PRECise?

Title: Measure Transmitter Frequency

Description: Sets the active measurement to code domain power, sets the default measurement parameters, triggers a new measurement and returns the transmitter frequency results. It is a combination of the commands :CONFigure:DEMod CDP and :READ:DEMod:TXFRrequency:PRECise?. For a description of the default code domain power measurement parameters, see :CONFigure:DEMod CDP. To make a transmitter frequency measurement with settings other than the default values, send:

:CONFigure:DEMod CDP

Commands to set desired settings

:READ:DEMod:TXFRrequency:PRECise?

Note that this command is the same as :MEASure:DEMod:TXFRrequency?, but returns the result with a precision of one-tenth Hertz.

Default Unit: Hertz

Related Command: :CONFigure:DEMod CDP
:MEASure:DEMod:TXFRrequency?

:MEASure:DEMod:TXFRequency?

Title: Measure Transmitter Frequency

Description: Sets the active measurement to code domain power, sets the default measurement parameters, triggers a new measurement and returns the transmitter frequency results. It is a combination of the commands :CONFigure:DEMod CDP and :READ:DEMod:TXFRequency? For a description of the default code domain power measurement parameters, see :CONFigure:DEMod CDP. To make a transmitter frequency measurement with settings other than the default values, send:

:CONFigure:DEMod CDP

Commands to set desired settings

:READ:DEMod:TXFRequency?

Default Unit: Hertz

Related Command: :CONFigure:DEMod CDP

:MEASure:EMISsion:FAIL?

Title: Measure Spectral Emission Mask Pass/Fail status

Description: Sets the active measurement to spectral emission mask, sets the default measurement parameters, triggers a new measurement and returns the spectral emission mask pass/fail results. It is a combination of the commands :CONFigure:RF EMISsion and :READ:EMISsion:FAIL? For a description of the default spectral emission mask measurement parameters, see :CONFigure:RF EMISsion. To make a spectral emission mask pass/fail status measurement with settings other than the default values, send:

:CONFigure:RF EMISsion

Commands to set desired settings

:READ:EMISsion:FAIL?

Related Command: :MEASure:EMISsion

:MEASure:EMISsion:TEMPlate?

:CONFigure:RF EMISsion

:MEASure:EMISsion:TEMPlate:DATA?

Title: Measure Spectral Emission Mask Template Data

Description: Sets the active measurement to spectral emission mask, sets the default measurement parameters, triggers a new measurement and returns the spectral emission mask template power level, frequency, and PASS/FAIL data for all ten frequency ranges shown in the Spectral Emission Summary. It is a combination of the commands :CONFigure:RF EMISsion and :READ:EMISsion:TEMPlate:DATA? For a description of the default spectral emission mask measurement parameters, see :CONFigure:RF EMISsion. To make a spectral emission mask template measurement with settings other than the default values, send:

:CONFigure:RF EMISsion
 Commands to set desired settings
 :READ:EMISsion:TEMPlate:DATA?

For each frequency range, the data is returned as 3 comma delimited values: Power Level in dBm, Frequency in Hz, and PASS/FAIL.

Related Command: :READ:EMISsion:TEMPlate:DATA?
 :FETCh:EMISsion:TEMPlate:DATA?
 :CONFigure:RF EMISsion

:MEASure:EMISsion:TEMPlate?

Title: Measure Spectral Emission Mask Template

Description: Sets the active measurement to spectral emission mask, sets the default measurement parameters, triggers a new measurement and returns the spectral emission mask template results. It is a combination of the commands :CONFigure:RF EMISsion and :READ:EMISsion:TEMPlate? For a description of the default spectral emission mask measurement parameters, see :CONFigure:RF EMISsion. To make a spectral emission mask template measurement with settings other than the default values, send:

:CONFigure:RF EMISsion
 Commands to set desired settings
 :READ:EMISsion:TEMPlate?

Related Command: :MEASure:EMISsion?
 :MEASure:EMISsion:FAIL?
 :CONFigure:RF EMISsion

:MEASure:EMISsion?

Title: Measure Spectral Emission Mask

Description: Sets the active measurement to spectral emission mask, sets the default measurement parameters, triggers a new measurement and returns the spectral emission mask measurement results. It is a combination of the commands :CONFigure:RF EMISsion and :READ:EMISsion? For a description of the default spectral emission mask measurement parameters, see :CONFigure:RF EMISsion. To make a spectral emission mask measurement with settings other than the default values, send:

:CONFigure:RF EMISsion
 Commands to set desired settings
 :READ:EMISsion?

Results are returned as 2 comma-delimited values: pass/fail status, and template number.

Related Command: :MEASure:EMISsion:FAIL?
 :MEASure:EMISsion:TEMPlate?

:MEASure:OBWidth?

Title: Measure Occupied Bandwidth

Description: Sets the active measurement to RF spectrum, sets the default measurement parameters, triggers a new measurement and returns the occupied bandwidth results. It is a combination of the commands :CONFigure:RF SPECTrum and :READ:OBWidth?. For a description of the default occupied bandwidth measurement parameters, see :CONFigure:RF SPECTrum. To make an occupied bandwidth measurement with settings other than the default values, send:

:CONFigure:RF SPECTrum

Commands to set desired settings

:READ:OBWidth?

Default Unit: Hz

Related Command: :CONFigure:OBWidth
:CONFigure:RF SPECTrum

:MEASure:OTA{1|2|3|4|5|6}?

Title: Measure Over The Air

Description: Sets the active measurement to over-the-air, sets the default measurement parameters, triggers a new measurement and returns the OTA measurement results. It is a combination of the commands :CONFigure:OTA and :READ:OBWidth? For a description of the default occupied bandwidth measurement parameters, see :CONFigure:RF SPECTRUM. To make an OTA measurement with settings other than the default values, send:

```
:CONFigure:OTA
Commands to set desired settings
:READ:OTA?
```

The measurement results are returned as 5 comma delimited values: scrambling code, CPICH power, chip energy, Ec/I0 ratio, pilot dominance.

Default Unit: Scrambling Code: No units
 CPICH power: dBm
 Chip Energy: dBm
 EC/I0: dB
 Pilot dominance: No units

Related Command: :CONFigure:OTA

:MEASure:PFail?

Title: Measure PASS/FAIL

Description: Sets the active measurement to PASS/FAIL, sets the default measurement parameters, triggers a new measurement and returns the PASS/FAIL results. It is a combination of the commands :CONFigure PFail and :READ:PFail? To make a PASS/FAIL measurement with settings other than the default values, send:

```
:CONFigure PFail
Commands to set desired settings
:READ:PFail?
```

Related Command: :CONFigure PFail
 READ:PFail?
 FETCh:PFail?

Front Panel

Access: Measurements, Pass/Fail Mode

:MEASure:PTAPower?

Title: Measure Peak to Average Power

Description: Sets the active measurement to RF spectrum, sets the default measurement parameters, triggers a new measurement and returns the PTAP measurement results. It is a combination of the commands :CONFigure:RF SPECTrum and :READ:PTAPower?. For a description of the default occupied bandwidth measurement parameters, see :CONFigure:RF SPECTrum. To make a peak to average power measurement with settings other than the default values, send:
:CONFigure:RF SPECTrum
Commands to set desired settings
:READ:PTAPower?

Default Unit: dB

Related Command: :CONFigure:RF SPECTrum

7-9 :MMEMory Subsystem

The Mass Memory subsystem contains functions that provide access to the instrument's setup and data storage.

:MMEMory:DELeTe <filename>

Title: Delete Setup/Measurement

Description: Removes a file specified by <filename> from the current mass storage device. <filename> should be enclosed in either single quotes (') or double quotes (" ") and it must include the file extension. Use the command MMEMory:MSIS to set the current file location.

Parameter: <filename>

Related Command: :MMEMory:STORe:STATe
:MMEMory:STORe:TRACe
:MMEMory:MSIS INTernal|USB

Front Panel

Access: Shift-7 (File), Delete, Delete Selected File

:MMEMory:LOAD:STATe <integer>,<filename>

Title: Recall Setup

Description: Recalls a previously stored instrument setup in the current save location. The setup file to be loaded is specified by <filename>. <filename> should be enclosed in either single quotes (') or double quotes (" ") and should contain a file extension ".stp". Use the command MMEMory:MSIS to set the current save location. The <integer> parameter is not currently used, but it must be sent. Send a 1.

Parameter: <integer>, <filename>

Related Command: :MMEMory:STORe:STATe
:MMEMory:MSIS INTernal|USB

Front Panel

Access: Shift-7 (File), Recall

:MMEMory:LOAD:TRACe <integer>,<filename>

Title: Recall Measurement

Description: The instrument must be in the mode of the saved trace in order to recall that trace. Use :INSTrument:SELeCt or :INSTrument:NSELeCt to set the mode. Recalls a previously stored measurement trace from the current save location. The saved measurement trace to be loaded is specified by <filename>. <filename> should be enclosed in either single quotes (') or double quotes (" ") and should contain a file extension. Note that the trace specified by <filename> should be available at the current save location. Use the command MMEMory:MSIS to set the current save location. The <integer> parameter is not currently used, but it must be sent. Send a 1.

File name extensions:

“.edg” for GSM
 “.spa” for SPA
 “.wcd” for WCDMA
 “.wmxd” for WiMAX
 “.wmxé” for Mobile WiMAX
 “.vna” for Cable & Antenna
 “.cdma” for CDMA
 “.tds” for TDSCDMA
 “.evdo” for EVDO
 “.ia” for Interference Analysis
 “.cs” for Channel Scanner
 “.pm” for Power Meter
 “.tm” for Transmission Measurement
 “.lte” for LTE Analyzer

Note: Extensions not available for T1 and Hi_PM.

Parameter: <integer>, <filename>

Example: To recall trace with file name “trace”:

```
:MMEMory:LOAD:TRACe 1, "trace.spa"
```

Related Command: :MMEMory:STORe:TRACe
 :MMEMory:STORe:TRACe
 :MMEMory:MSIS INTernal|USB

Front Panel

Access: Shift-7 (File), Recall Measurement

:MMEMory:STORe:PFail <header><block>

Title: Store PASS/FAIL Test Definitions

Description: Stores a new PASS/FAIL test definition file in the internal file space for future use. The ASCII header specifies the number of data bytes. It looks like #AX, where A is the number of digits in X and X is the number of bytes in the <block>. The format of the block data is always ASCII text. The contents of the block data is the contents of a Pass/Fail test definition file. These files can be generated using the Pass/Fail Test Editor that is included with the Anritsu Master Software Tools Measurement Editor. For the latest Master Software Tools, visit the Anritsu website at <http://www.us.anritsu.com>.

Parameter: <header><block>

Related Command: :CONFigure PFail
 :FETCh:PFail?
 :MEASure:PFail?
 :READ:PFail?

:MMEMory:STORe:STATe <integer>,<filename>

Title: Save Setup

Description: Stores the current setup into the file specified by <filename>. <filename> should be enclosed in either single quotes (') or double quotes (" ") and should not contain a file extension. Use the command MMEMory:MSIS to set the current save location. The <integer> parameter is not currently used, but it must be sent. Send a value of 0.

Parameter: <integer>, <filename>

Related Command: :MMEMory:LOAD:STATe
:MMEMory:MSIS INTernal|USB

Front Panel

Access: Shift-7 (File)

:MMEMory:STORe:TRACe <integer>,<filename>

Title: Save Measurement

Description: Stores the trace into the file specified by <filename>. <filename> should be enclosed in either single quotes (') or double quotes (" ") and should not contain a file extension. Use the command MMEMory:MSIS to set the current save location. The <integer> parameter is not currently used, but it must be sent. Send a 0. Note that existing files of the same name will not be overwritten.

Parameter: <integer>, <filename>

Example: To save the trace into the file name "trace":

```
:MMEMory:STORe:TRACe 0,"trace"
```

Related Command: :MMEMory:LOAD:TRACe
:MMEMory:MSIS INTernal|USB

Front Panel

Access: Shift-7 (File), Save

7-10 :READ Subsystem

This set of commands combines the ABORT, INITiate and FETCh commands. It aborts any current triggering sequence and sets the trigger state to idle. It then initiates a new active measurement (i.e. begins the collection of new data). When the measurement is complete, it returns the result. These commands will not switch to another measurement.

To get the current measurement data, use the FETCh command.

:READ:ACLR?

Title: Read Adjacent Channel Leakage Ratio (ACLR)

Description: Triggers a new adjacent channel power ratio measurement and returns the results: main channel power, lower adjacent and upper adjacent channel power, and lower alternate and upper alternate channel power. It is a combination of the commands :ABORT; :INITiate; :FETCh:ACLR? The ACLR measurement must be the active measurement (specified by :CONFigure:RF ACLR). The current measurement can be queried using :CONFigure?

Data is returned as 12 comma-separated values: -20 MHz channel power, -15 MHz channel power, -10 MHz channel power, -5 MHz channel power, Main channel power 1, Main channel power 2, Main channel power 3, Main channel power 4, +5 MHz channel power, +10 MHz channel power, +15 MHz channel power, +20 MHz channel power.

Related Command: :CONFigure:RF ACLR

:READ:CHPower?

Title: Read Channel Power

Description: Triggers a new channel power measurement and returns the channel power result. It is a combination of the commands :ABORT; :INITiate; :FETCh:CHPower:CHPower? It returns only the channel power, not the channel power density. The channel power measurement must be the active measurement (specified by :CONFigure:CHPower). The current measurement can be queried using the :CONFigure? command.

Default Unit: Current amplitude units

Related Command: :READ:CHPower?
:READ:CHPower:DENSity?
:CONFigure

:READ:DEMod:ACTChannels?

Title: Read Active Code Domain Channel Count

Description: Triggers a new measurement and returns the active channel count. It is a combination of the commands :ABORT; :INITiate; :FETCh:DEMod:ACTChannels? A demodulation measurement must be active. The current measurement can be queried using :CONFigure?

Default Unit: dB

Related Command: :CONFigure:DEMod

:READ:DEMod:CDPower?

Title: Read Code Domain Power

Description: Triggers a new measurement and returns the Pilot Power, Channel Power, Noise Floor, Rho, Carrier Feed Through, Tau, RMS Phase Error, Frequency Error, Frequency Error PPM, Page, Sync, and Q Page measurement results. It is a combination of the following commands :ABORT; :INITiate; :FETCh:DEMod:CDPower? In order for the data to be accurate, the Code Domain Power measurement must be the active measurement (specified by :CONFigure:DEMod CDPower). The current measurement can be queried using :CONFigure?

Data is returned as 12 comma-delimited values: Pilot Power in the current user set unit (dBm/W/mW), Channel Power in the current user set unit (dBm/W/mW), Noise Floor in dB, Rho, Carrier Feed Through in dB, Tau in ps, RMS Phase Error in deg, Frequency Error in Hz, Frequency Error PPM, Page in dBm, Sync in dBm, and Q Page. All invalid values are replaced with "--".

Default Unit: dBm

Related Command: CONFigure:DEMod CDPower
:MEASure:DEMod:CDPower?
:FETCh:DEMod:CDPower?

Front Panel

Access: Measurements, Demodulator, CDP

:READ:DEMod:CFTHrough?

Title: Read Carrier Feed Through

Description: Triggers a new measurement and returns the carrier feed through results. It is a combination of the commands :ABORT; :INITiate; :FETCh:DEMod:CFTHrough? The carrier feed through measurement must be active. The current measurement can be queried using :CONFigure?

Default Unit: dB

:READ:DEMod:EVM?

Title: Read Error Vector Magnitude (EVM)

Description: Triggers a new measurement and returns the EVM results. It is a combination of the commands :ABORT; :INITiate; :FETCh:DEMod:EVM? The EVM measurement must be active. The current measurement can be queried using :CONFigure?

Default Unit: %

Related Command: :CONFigure:DEMod

:READ:DEMod:FERRor:PPM?

Title: Read Frequency Error PPM

Description: See Also: :CONFigure:DEMod Triggers a new measurement and returns the frequency error results. It is a combination of the commands :ABORT; :INITiate; :FETCh:DEMod:FERRor:PPM? The frequency error PPM measurement must be active. The current measurement can be queried using :CONFigure?

Related Command: :MEASure:DEMod:FERRor:PPM?
:FETCh:DEMod:FERRor:PPM?
:CONFigure:DEMod CDP

:READ:DEMod:FERRor:PRECise?

Title: Read Frequency Error

Description: Triggers a new measurement and returns the frequency error results. It is a combination of the commands :ABORT; :INITiate; :FETCh:DEMod:FERRor:PRECise? The frequency error measurement must be active. The current measurement can be queried using :CONFigure? Note that this command is the same as :READ:DEMod:FERRor?, but returns the result with a precision of one-tenth Hertz.

Default Unit: Hertz

Related Command: :CONFigure:DEMod
:READ:DEMod:FERRor?

:READ:DEMod:FERRor?

Title: Read Frequency Error

Description: Triggers a new measurement and returns the frequency error results. It is a combination of the commands :ABORT; :INITiate; :FETCh:DEMod:FERRor? The frequency error measurement must be active. The current measurement can be queried using :CONFigure?

Default Unit: Hertz

Related Command: :CONFigure:DEMod

:READ:DEMod:HSDPa:FERRor:PPM?

Title: Read HSDPA Frequency Error PPM

Description: Triggers a new measurement and returns the frequency error results. It is a combination of the commands :ABORT; :INITiate; :FETCh:DEMod:HSDPa:FERRor:PPM? The HSDPA frequency error PPM measurement must be active. The current measurement can be queried using :CONFigure?

Related Command: :MEASure:DEMod:HSDPa:FERRor:PPM?
:FETCh:DEMod:HSDPa:FERRor:PPM?
:CONFigure:DEMod HSDPa

:READ:DEMod:HSDPa:FERRor?

Title: Read HSDPA Frequency Error

Description: Triggers a new measurement and returns the frequency error results. It is a combination of the commands :ABORT; :INITiate; :FETCh:DEMod:HSDPa:FERRor? The HSDPA frequency error measurement must be active. The current measurement can be queried using :CONFigure?

Default Unit: Hertz

Related Command: :MEASure:DEMod:HSDPa:FERRor?
:FETCh:DEMod:HSDPa:FERRor?
:CONFigure:DEMod HSDPa

:READ:DEMod:HSDPa:TXFREquency?

Title: Read HSDPA Transmitter Frequency

Description: Triggers a new measurement and returns the HSDPA transmitter frequency results. It is a combination of the commands :ABORT; :INITiate; :FETCh:DEMod:HSDPa:TXFREquency? The HSDPA transmitter frequency measurement must be active. The current measurement can be queried using :CONFigure?

Default Unit: Hz

Related Command: :MEASure:DEMod:HSDPa:TXFREquency?
:FETCh:DEMod:HSDPa:TXFREquency?
:CONFigure:DEMod HSDPa

:READ:DEMod:NFLoor?

Title: Read Noise Floor

Description: Triggers a new measurement and returns the noise floor results. It is a combination of the commands :ABORT; :INITiate; :FETCh:DEMod:NFLoor? The noise floor measurement must be active. The current measurement can be queried using :CONFigure?

Default Unit: dB

Related Command: :CONFigure:DEMod

:READ:DEMod:NUMChannels?

Title: Read Code Domain Channel Count

Description: Triggers a new measurement and returns the channel count. It is a combination of the commands :ABORT; :INITiate; :FETCh:DEMod:NUMChannels? A demodulation measurement must be active. The current measurement can be queried using :CONFigure?

Default Unit: dB

Related Command: :CONFigure:DEMod

:READ:DEMod:SPOWer?

Title: Read Synch Channel Power

Description: Triggers a new measurement and returns the synch channel power results. It is a combination of the commands :ABORT; :INITiate; :FETCh:DEMod:SPOWer? The synch channel power measurement must be active. The current measurement can be queried using :CONFigure?

Results are returned as 3 comma-delimited values: SCH power, PSCH power, SSCH power.

Default Unit: dBm

Related Command: :CONFigure:DEMod

:READ:DEMod:TXFRequency:PRECise?

Title: Read Transmitter Frequency

Description: Triggers a new measurement and returns transmitter frequency results. It is a combination of the commands :ABORT; :INITiate; :FETCh:DEMod:TXFRequency:PRECise? The carrier frequency measurement must be active. The current measurement can be queried using :CONFigure? Note that this command is the same as :READ:DEMod:TXFRequency?, but returns the result with a precision of one-tenth Hertz.

Default Unit: Hz

Related Command: :CONFigure:DEMod
:READ:DEMod:TXFRequency?

:READ:DEMod:TXFrequency?

Title: Read Transmitter Frequency

Description: Triggers a new measurement and returns transmitter frequency results. It is a combination of the commands :ABORT; :INITiate; :FETCh:DEMod:TXFrequency? The carrier frequency measurement must be active. The current measurement can be queried using :CONFigure?

Default Unit: Hz

Related Command: :CONFigure:DEMod

:READ:EMISsion:FAIL?

Title: Read Spectral Emission Mask Pass/Fail Status

Description: Triggers a new spectral emission mask measurement and returns the pass/fail results. It is a combination of the commands :ABORT; :INITiate; :FETCh:EMISsion:FAIL? The spectral emission mask measurement must be active. The current measurement can be queried using :CONFigure?

Related Command: :CONFigure:RF EMISsion

:READ:EMISsion:TEMPlate:DATA?

Title: Read Spectral Emission Mask Template Data

Description: Triggers a new spectral emission mask measurement and returns the spectral emission mask template power level, frequency, and PASS/FAIL data for all ten frequency ranges shown in the Spectral Emission Summary. It is a combination of the commands :ABORT; :INITiate; :FETCh:EMISsion:TEMPlate:DATA? The spectral emission mask measurement must be active. The current measurement can be queried using :CONFigure?

For each frequency range, the data is returned as 3 comma delimited values: Power Level in dBm, Frequency in Hz, and PASS/FAIL.

Related Command: :MEASure:EMISsion:TEMPlate:DATA?
:FETCh:EMISsion:TEMPlate:DATA?
:CONFigure:RF EMISsion

:READ:EMISsion:TEMPlate?

Title: Read Spectral Emission Mask Template

Description: Triggers a new spectral emission mask measurement and returns the template number result. It is a combination of the commands :ABORT; :INITiate; :FETCh:EMISsion:TEMPlate? The spectral emission mask measurement must be active. The current measurement can be queried using :CONFigure?

Related Command: :CONFigure:RF EMISsion

:READ:EMISsion?

Title: Read Spectral Emission Mask

Description: Triggers a new spectral emission mask measurement and returns the results: pass/fail status and template number. It is a combination of the commands :ABORT; :INITiate; :FETCh:EMISsion? The spectral emission mask measurement must be active. The current measurement can be queried using :CONFigure?

Results are returned as 2 comma-delimited values: pass/fail status, and template number.

Related Command: :CONFigure:RF EMISsion

:READ:OBWidth?

Title: Read Occupied Bandwidth

Description: Triggers a new occupied bandwidth measurement and returns the results: occupied bandwidth, percent of power and dB down. It is a combination of the commands :ABORT; :INITiate; :FETCh:OBWidth? The occupied bandwidth measurement must be the active measurement (specified by :CONFigure:OBWidth). The current measurement can be queried using the :CONFigure?

Default Unit: Hz

Related Command: :CONFigure

:READ:OTA{1|2|3|4|5|6}?

Title: Read Over The Air

Description: Triggers a new over-the-air measurement and returns the result. It is a combination of the commands :ABORT; :INITiate; :FETCh:OTA? The over-the-air measurement must be active. The current measurement can be queried using :CONFigure?

The measurement results are returned as 5 comma delimited values: scrambling code, CPICH power, chip energy, Ec/I0 ratio, pilot dominance.

Default Unit: Scrambling Code: No units
CPICH power: dBm
Chip Energy: dBm
EC/I0: dB
Pilot dominance: No units

Related Command: :CONFigure:OTA

:READ:PFail?

Title: Read PASS/FAIL

Description: Triggers a new PASS/FAIL measurement and returns the results. It is a combination of the commands :ABORT; :INITiate; :FETCh:PFail? The PASS/FAIL measurement must be active. The current measurement can be queried using :CONFigure?

Related Command: :FETCh:PFail?
:CONFigure PFail
:MEASure:PFail?

Front Panel

Access: Measurements, Pass/Fail Mode

:READ:PTAPower?

Title: Read Peak to Average Power Ratio

Description: Triggers a new measurement and returns the peak to average power ratio result. It is a combination of the commands :ABORT; :INITiate; :FETCh:PTAPower? The peak to average power measurement must be active. The current measurement can be queried using :CONFigure?

Default Unit: dB

Related Command: :CONFigure:RF

7-11 :TRACe Subsystem

This subsystem contains commands related to the transfer of trace data to and from the instrument.

:TRACe:PREamble? <trace type>

Title: Trace Header Transfer

Description: The <trace type> must be one of the following: ACLR|SPECTrum|EMISsion|DEMod. Returns trace header information for the specified trace. Data can be transferred to and from the 4 available display trace types.

Use the commands in the MMEMory subsystem to store and recall traces from the instrument memory. The response begins with an ASCII header. The header specifies the number of following bytes. It looks like #AX, where A is the number of digits in X and X is the number of bytes that follow the header. Parameters are returned in comma-delimited ASCII format. Each parameter is returned as "NAME=VALUE[UNITS]," Valid parameter names are shown in ["WCDMA Parameter Names" on page 2-25](#).

Parameter: <trace type>

Related Command: :TRACe:DATA?

:TRACe[:DATA]

ACLR|SPECTrum|EMISsion|DEMod, (<header><block>)

:TRACe[:DATA]? ACLR|SPECTrum|EMISsion|DEMod

Title: Trace Data Transfer

Description: This command transfers data from the controlling program to the instrument. The query form transfers trace data from the instrument to the controller. Before executing this command the instrument must be set to the desired measurement.

The ASCII header specifies the number of data bytes. It looks like #AX, where A is the number of digits in X and X is the number of bytes in the <block>. The number of bytes in the block is calculated by multiplying the number of data points by the number of bytes used to transfer each data point. Also note that the second argument must be enclosed in parentheses.

The format of the block data in the query form is specified by :FORMat:DATA. The block data in the command form is always sent in ASCII format. Trace setup information can be acquired using :TRACe[:DATA]:PREamble?. Data can be transferred to and from the 4 available display types. Use the commands in the MMEMory subsystem to store and recall traces from the instrument memory. This command does not support setting all trace points to a single value. To do this, send the same value to each point. For RF traces (ACLR, Spectrum and EMISsion), there is only one value per data point.

For example, to transfer a 501 point trace from the controlling program to the ACLR trace in the instrument the command :TRACe:DATA ACLR,(#42004<block>) would be sent. <block> data could be in either INTEger,32 or REAL,32 format. In both cases, there would be 4 bytes per data point. So, 4 bytes per point * 501 data points gives 2004 bytes in <block> data. For the demodulated code domain power trace, each data point is represented by 6 values of 4 bytes each: code number (no units), absolute power (dBm), relative power (dB), spreading factor (no units), symbol EVM (%), code state(0 = Inactive, 1 = Active). If Option 65 is installed code state will indicate the modulation type (0 = Noise, 1 = QPSK, 2 = 16_QAM).

Note that the instrument must be set in the selected view. Use the CONFIgure command to set the unit to the selected view.

Parameter: ACLR | SPEctrum | EMISsion | DEMod,(<header><block>)

Parameter Type: <char>

Related Command: :FORMat:DATA
:TRACe[:DATA]:PREamble?

7-12 [:SENSE] Subsystem

The commands in this subsystem relate to device-specific parameters, not signal-oriented parameters.

[:SENSE] :AVERAge:FERRor OFF|ON|0|1

[:SENSE] :AVERAge:FERRor?

Title: Frequency Error Averaging State

Description: Turns averaging for Frequency Error ON or OFF. Setting the value to ON or 1 will result in turning frequency error averaging ON.

The Query form of this command returns either "1" or "0". "1" corresponds to frequency error averaging being ON and "0" corresponds to frequency error averaging being OFF.

Parameter: OFF|ON|0|1

Parameter Type: <boolean>

Default Value: OFF

Related Command: [:SENSE] :AVERAge:FERRor:COUNT
[:SENSE] :AVERAge:FERRor:COUNT?
:MMEMory:LOAD:TRACe

Front Panel

Access: Setup, More, Freq Err Avg

[:SENSE] :AVERAge:FERRor:COUNT <integer>

[:SENSE] :AVERAge:FERRor:COUNT?

Title: Average Frequency Error Count

Description: Sets the number that is used for averaging the frequency error.

Parameter: <integer>

Parameter Type: <integer>

Default Value: 2

Range: 2 to 15

Related Command: [:SENSE] :AVERAge:FERRor
[:SENSE] :AVERAge:FERRor?

Front Panel

Access: Setup, More, Freq Err Avg Cnt

[:SENSe]:DEMod:CODogram:TIME <seconds>

[:SENSe]:DEMod:CODogram:TIME?

Title: Codogram Measurement Time

Description: This command refers to the minimum elapsed time between successive codogram measurements.

Parameter: <seconds>

Default Value: 5 seconds

Range: 5 seconds to 6000 seconds

[:SENSe]:DEMod:CPICH:ABSolute?

Title: Absolute Common Pilot Channel (CPICH) Level

Description: Queries the absolute Common Pilot Channel level.

Default Unit: dB

Related Command: MEASure:DEMod:CDPower?
READ:DEMod:CDPower?
FETCh:DEMod:CDPower?

[:SENSe]:DEMod:CPICH:RELative?

Title: Relative Common Pilot Channel (CPICH) Level

Description: Queries the relative Common Pilot Channel level.

Default Unit: dB

Related Command: MEASure:DEMod:CDPower?
:READ:DEMod:CDPower?
:FETCh:DEMod:CDPower?

[:SENSe]:DEMod:CTRLchannels:UNIT RELative|ABSolute|DELTA

[:SENSe]:DEMod:CTRLchannels:UNIT?

Title: Control Channels Display Units

Description: This command refers to the display units for the control channels in the HSDPA and CDP view. Setting the value to RELative will result in displaying P-CCPCH, S-CCPCH, PICH, P-SCH and S-SCH in relative powers. Setting the value to ABSolute will result in displaying P-CCPCH, S-CCPCH, PICH, P-SCH and S-SCH in absolute powers.

Parameter: RELative|ABSolute|DELTA

Parameter Type: <char>

Default Value: RELative

Range: RELative|ABSolute|DELTA

Front Panel

Access: Measurements, Demodulator, HSDPA, Control Channels,
Measurements, Demodulator, CDP, Control Channels

[:SENSE] :DEMod:HSDPa:IQPersistence <integer>

[:SENSE] :DEMod:HSDPa:IQPersistence?

Title: HSDPA IQ Persistence

Required Option: 65

Description: Sets the number of samples before displaying the screen.

Parameter: <integer>

Parameter Type: <integer>

Default Value: 1

Range: 1 to 48

Front Panel

Access: Measurements, Demodulator, HSDPA, IQ Persistence

[:SENSE] :DEMod:HSDPa:TIME <seconds>

[:SENSE] :DEMod:HSDPa:TIME?

Title: HSDPA Measurement Time

Required Option: 65

Description: This command sets the single sweep time.

Parameter: <seconds>

Default Value: 5 seconds

Range: 5 to 6000 seconds

Front Panel

Access: Measurements, Demodulator, HSDPA, Single Sweep Time

[:SENSE] :DEMod:PCCPch:RELative?

Title: Relative Primary Common Control Physical Channel (P-CCPCH) Level

Description: Queries the relative Primary Common Control Physical Channel level.

Default Unit: dB

Related Command: MEASure:DEMod:CDPower?
:READ:DEMod:CDPower?
:FETCh:DEMod:CDPower?

[:SENSE] :DEMod:PCDerror?

Title: Peak Code Domain Error

Description: Queries the Peak Code Domain Error.

Default Unit: dB

[:SENSe] :DEMod:PICH:CODE <code number>

[:SENSe] :DEMod:PICH:CODE?

Title: PICH Code Number

Description: This command refers to the channelization code number of the PICH channel for W-CDMA code domain demodulation measurements.

Parameter: <code number>

Default Value: 16

Range: 0 to 255

Front Panel

Access: Setup, PICH Code

[:SENSe] :DEMod:SCCPch:CODE <code number>

[:SENSe] :DEMod:SCCPch:CODE?

Title: S-CCPCH Code Number

Description: This command refers to the channelization code number of the S-CCPCH channel for W-CDMA code domain demodulation measurements.

Parameter: <code number>

Default Value: 3

[:SENSe] :DEMod:SCCPch:SFACTOR 4|8|16|32|64|128|256

[:SENSe] :DEMod:SCCPch:SFACTOR?

Title: S-CCPCH Spreading Factor

Description: This command refers to the spreading factor of the S-CCPCH channel for W-CDMA code domain demodulation measurements.

Parameter: 4|8|16|32|64|128|256

Default Value: 256

Front Panel

Access: Setup, S-CCPCH Spread

[:SENSE] :DEMod:SCODE <scrambling code>

[:SENSE] :DEMod:SCODE?

Title: Scrambling Code

Description: This command refers to the primary scrambling code used for W-CDMA code domain demodulation measurements. When the auto scrambling code feature is turned on, this setting will be overwritten by the automatically detected value.

Parameter: <scrambling code>

Default Value: 0

Range: 0 to 255

Front Panel

Access: Setup, Scrambling Code Setup, S-CCPCH Code

[:SENSE] :DEMod:SCODE:AUTO OFF|ON|0|1

[:SENSE] :DEMod:SCODE:AUTO?

Title: Automatic Scrambling Code Detection

Description: Sets the state of the automatic scrambling code detection feature. Setting the value to ON or 1 will result in the scrambling code being set to the code of the strongest detected signal. That is, the instrument will detect the strongest signal present and use the scrambling code of that signal for demodulation. Setting the value to OFF or 0 will force the instrument to base all demodulation on the user-selected scrambling code value. The default value is ON. That is, sending :SENS:DEM:SCOD:AUTO is equivalent to sending :SENS:DEM:SCOD:AUTO ON.

Parameter: OFF|ON|0|1

Parameter Type: <boolean>

Default Value: ON

Related Command: [:SENSE] :DEMod:SCODE

Front Panel

Access: Setup, Scrambling Code

[:SENSE] :DEMod:SFACTOR 256|512

[:SENSE] :DEMod:SFACTOR?

Title: Maximum Spreading Factor

Description: This command refers to the maximum spreading factor used when demodulating a UMTS/W-CDMA signal.

Parameter: 256|512

Default Value: 512

Front Panel

Access: Setup, Max Spreading

[:SENSe]:DEMod:THRShold <rel ampl>

[:SENSe]:DEMod:THRShold?

Title: Active Code Threshold

Description: This command refers to the threshold used for detecting active vs. inactive traffic channels in W-CDMA code domain demodulation measurements. If the automatic threshold feature is used, this setting will be overwritten by the automatically detected threshold.

Parameter: <rel ampl>

Default Value: -30 dB

Range: -50 dB to -10 dB

[:SENSe]:DEMod:THRShold:AUTO OFF|ON|0|1

[:SENSe]:DEMod:THRShold:AUTO?

Title: Automatic Threshold

Description: Sets the state of the automatic threshold feature. Setting the value to ON or 1 will enable the automatic threshold feature. Setting the value to OFF or 0 will disable the automatic threshold feature. The default value is ON. That is, sending :SENS:DEM:THRS:AUTO is equivalent to sending :SENS:DEM:THRS:AUTO ON.

Parameter: OFF|ON|0|1

Parameter Type: <boolean>

Default Value: ON

Related Command: [:SENSe]:DEMod:THRShold

Front Panel

Access: Setup, More, Threshold

[:SENSe]:FREQuency:CENTer <freq>

[:SENSe]:FREQuency:CENTer?

Title: Center Frequency

Description: Sets the center frequency. Note that changing the value of the center frequency will change the value of the coupled parameters Start Frequency and Stop Frequency. It may also change the value of the span.

Parameter: <freq>

Default Value: 1 GHz

Default Unit: Hz

Range: 824 MHz to 2.7 GHz

Front Panel

Access: Freq, Center Freq

[:SENSE]:FREQUENCY:SIGStandard:CHANNEL <number>

[:SENSE]:FREQUENCY:SIGStandard:CHANNEL?

Title: Channel Selection

Description: Sets the channel number for the selected signal standard.

Parameter: <number>

Front Panel

Access: Freq, Channel

[:SENSE]:FREQUENCY:SIGStandard:NAME <string>

[:SENSE]:FREQUENCY:SIGStandard:NAME?

Title: Signal Standard

Description: Selects the desired signal standard from the list. The <string> argument is the name of the desired signal standard as displayed in the instrument's current signal standard list. The list can be displayed on the instrument by choosing the Signal Standard submenu button in the Freq menu. The list can also be downloaded remotely and viewed using Anritsu Master Software Tools. For example, if the desired Signal Standard is P-GSM 900 - Uplink, then the value of the <string> argument would be "P-GSM 900 - Uplink". The query form of this command will return the name of the currently selected Signal Standard on the list.

Parameter: <string>

Front Panel

Access: Freq, Signal Standard

[:SENSE]:FREQUENCY:START?

Title: Start Frequency

Description: Queries the start frequency of the RF Band Spectrum. Note that this command is valid only if the current view is set to RF Band Spectrum.

Parameter: <freq>

Default Unit: Hz

Related Command: [:SENSE]:FREQUENCY:STOP?

Front Panel

Access: Freq, Start Freq

[:SENSE]:FREQUENCY:STOP?

Title: Stop Frequency

Description: Queries the stop frequency of the RF Band Spectrum. Note that this command is valid only if the current view is set to RF Band Spectrum.

Parameter: <freq>

Default Unit: Hz

[:SENSe]:OTA:RESet

Title: OTA Reset

Description: This command forces the instrument to reset the over-the-air measurement and start fresh without any history. When the auto scrambling code feature is ON the RESet command will clear the list of scrambling codes and attempt to detect new codes. When the auto scrambling code feature is OFF the RESet command will force the instrument to take new measurements for all of the user-selected scrambling codes.

Front Panel

Access: Measurements, OTA, Scrambling Code, Reset

[:SENSe]:OTA:SCODE:AUTO OFF|ON|0|1**[:SENSe]:OTA:SCODE:AUTO?**

Title: Automatic OTA Scrambling Code Detection

Description: Sets the state of the automatic scrambling code detection feature. Setting the value to ON or 1 will result in the scrambling codes being set to the codes of the strongest detected signals. That is, the instrument will detect the strongest signals present. Setting the value to OFF or 0 will force the instrument to base all over-the-air measurements on the user-selected scrambling code values. The default value is ON. That is, sending :SENS:DEM:OTA:SCOD:AUTO is equivalent to sending :SENS:DEM:OTA:SCOD:AUTO ON.

Parameter: OFF|ON|0|1

Parameter Type: <boolean>

Default Value: ON

Related Command: [:SENSE]:DEMod:OTA:SCODE

Front Panel

Access: Measurements, OTA, Scrambling Code, Scrambling Code (Auto)

[:SENSE] :OTA:SCODE:LOCK OFF|ON|0|1

[:SENSE] :OTA:SCODE:LOCK?

Title: OTA Scrambling Code Lock

Description: This command refers to the primary scrambling codes used for W-CDMA over-the-air measurements. When scrambling code lock is ON, the instrument will not search for any new scrambling codes and will only measure the codes that have already been detected. When scrambling code lock is OFF, the instrument will dynamically update the list of scrambling codes that are to be included in the current measurements. This feature has no effect when scrambling code auto detection is OFF for over-the-air measurements. The default value for this command is ON. That is, sending SENS:DEM:OTA:LOCK is equivalent to SENS:DEM:OTA:LOCK ON.

Parameter: OFF|ON|0|1

Parameter Type: <boolean>

Default Value: OFF

Front Panel

Access: Measurements, OTA, Scrambling Code, Code Lock

[:SENSE] :OTA:SCODE{1|2|3|4|5|6}<scrambling code>

[:SENSE] :OTA:SCODE{1|2|3|4|5|6}?

Title: OTA Scrambling Code

Description: This command refers to the primary scrambling codes used for W-CDMA over-the-air measurements. To disable the specified code use a scrambling code value of '-1'. When the auto scrambling code feature is turned on, setting this value has no direct effect on measurement results.

Parameter: <scrambling code>

Default Value: -1

Range: -1 to 511

Front Panel

Access: Measurements, OTA, Scrambling Code, Manual Code

[:SENSe]:OTA:SORT CODE|POWer

[:SENSe]:OTA:SORT?

Title: OTA Sort Parameter

Description: This command refers to the parameter that is used to sort the over-the-air measurement results.

Parameter: CODE|POWer

Parameter Type: <char>

Default Value: CODE

Front Panel

Access: Measurements, OTA, Scrambling Code, Sort By

[:SENSe]:PFail <test set>

[:SENSe]:PFail?

Title: PASS/FAIL Test Selection

Description: Selects the active test set to be used in subsequent PASS/FAIL measurements. The <test set> value must correspond to a test set that is defined in the test set list. For more information on loading test sets to the instrument, see the :MMEMory:STORe:PFail command. NOTE: The first test set in the list would be test set 0, the next test set would be 1, etc.

When using the query form of the command, the return value is the currently selected test set number. If there is not a valid test set selected, the return value is "-1" (negative 1).

Parameter: <test set>

Related Command: :CONFigure PFail

Front Panel

Access: Measurements, Pass/Fail Mode, Select Pass/Fail Test

[:SENSe]:POWer[:RF]:RANGe:AUTO OFF|ON|0|1

[:SENSe]:POWer[:RF]:RANGe:AUTO?

Title: Automatic Amplitude Range

Description: Sets the automatic amplitude range. Setting the value to ON or 1 will result in the amplitude range being coupled to the detected input signal level. Setting the value to OFF or 0 will result in the input attenuation being un-coupled from the input signal level. That is, changing the input signal level will not change the amplitude range. When this command is issued, the amplitude range itself will not change. The default value is ON. That is, sending :SENS:POW:RANG:AUTO is equivalent to sending :SENS:POW:RANG:AUTO ON.

Parameter: OFF|ON|0|1

Parameter Type: <boolean>

Default Value: ON

Related Command: [:SENSe]:POWer[:RF]:RANGe

Front Panel

Access: Amplitude, Auto Range

[:SENSe]:POWer[:RF]:RANGe[:IMMediate]

Title: Amplitude Range

Description: Re-calculates amplitude range. Note that issuing this command will set the automatic dynamic range OFF.

Related Command: [:SENSe]:POWer[:RF]:RANGe:AUTO

Front Panel

Access: Amplitude, Adjust Range

[:SENSe]:RF:ACLR:ADJCchannelcount <num of channels>

[:SENSe]:RF:ACLR:ADJCchannelcount?

Title: ACLR ADJC Channel Count

Description: This command refers to the number of Adjacent channels in the ACLR view.

Parameter: <num of channels>

Default Value: 2

Range: 1 to 4

Front Panel

Access: Measurements, RF Measurements, ACLR, Select # of Adjacent Channels

[:SENSE]:RF:ACLR:MAINchannelcount <num of main channels>

[:SENSE]:RF:ACLR:MAINchannelcount?

Title: ACLR MAIN Channel Count

Description: This command refers to the number of main channels in the ACLR view.

Parameter: <num of main channels>

Default Value: 1 Main Channel

Range: 1 to 4

Front Panel

Access: Measurements, RF Measurements, ACLR, Select # of Main Channels

Chapter 8 — TDSCDMA Commands

8-1 :ABORt Subsystem

The abort subsystem includes commands that allow the user to stop current measurement activities on the instrument.

:ABORt

Title: Abort

Description: Restarts the current sweep and/or measurement. Resets the trigger system. If :INITiate:CONTinuous is OFF (i.e. the instrument is in single sweep mode), send the command :INITiate[:IMMediate] to trigger the next sweep. If :INITiate:CONTinuous is ON (i.e. the instrument is in continuous sweep mode), a new sweep will start immediately.

Parameter: NA

Related Command: :INITiate:CONTinuous
:INITiate[:IMMediate]

8-2 :CONFigure Subsystem

This set of commands prepares the instrument for the selected measurement. It disables any currently-enabled measurements and activates the specified measurement. It sets the instrument to single sweep mode, waiting for an :INITiate command. It will not initiate the taking of a measurement.

Current instrument settings may be changed to default values. These changes are identified with their respective measurement commands.

:CONFigure SUMMary|PFail

Title: Configure Summary and Pass/Fail Measurements

Description: This command configures the summary and PASS/FAIL measurements. It disables any other active measurements. None of the instrument parameters are changed by the execution of this command. Sets the instrument to single sweep mode (:INITiate:CONTinuous OFF). Measurement settings can be modified by using the [:SENSE] commands before initiating a measurement.

Parameter: SUMMary|PFail

Parameter Type: <char>

Front Panel

Access: Shift-4 (Measure), TD-SCDMA Summary or Pass/Fail Mode

:CONFigure:DEMod <char>

Title: Configure Demodulation Measurement

Required Option: 43

Description: Valid <char> parameter options: SUMMary|CDPData

This command configures the selected demodulation measurement. It disables any other active measurements. Sets the instrument to single sweep mode (:INITiate:CONTinuous OFF). Measurement settings can be modified by using the [:SENSE]:DEMod commands before initiating a measurement. When the SUMMARY option is selected, the measurement results are equivalent to the results that are displayed by choosing Measurements, then Demodulator, then Modulation Summary from the front panel. When the CDPData option is selected, the measurement results are equivalent to the results that are displayed by choosing Measurements, then Demodulator, then CDP from the front panel.

Parameter: <char>

Front Panel

Access: Measurements, Demodulator

:CONFigure:OTA

Title: Configure Over-The-Air Measurement

Required Option: 33

Description: Valid parameter options: CSCan|TSCan

This command configures the selected Over The Air measurement. It disables any other active measurements. Sets the instrument to single sweep mode (:INITiate:CONTinuous OFF). Measurement settings can be modified before initiating a measurement. When the CSCan option is selected, the measurement results are equivalent to the results that are displayed by choosing Measurements, then OTA, then Code Scan from the front panel. When the TSCan option is selected, the measurement results are equivalent to the results that are displayed by choosing Measurements, then OTA, then Tau Scan from the front panel.

:CONFigure:RF <char>

Title: Configure RF Measurement

Required Option: 42

Description: Valid parameter options: SUMMary|SPECtrum|PVTSlot|EMISSion

This command configures the selected RF measurement. It disables any other active measurements. Sets the instrument to single sweep mode (:INITiate:CONTinuous OFF). Measurement settings can be modified by using the [:SENSe]:RF commands before initiating a measurement.

When the SUMMary option is selected, the measurement results are equivalent to the results that are displayed by choosing Measurements, then RF Measurements, then RF Summary from the front panel. When the SPECtrum option is selected, the measurement results are equivalent to the results that are displayed by choosing Measurements, then RF Measurements, then Channel Spectrum from the front panel. When the PVTSlot option is selected, the measurement results are equivalent to the results that are displayed by choosing Measurements, then RF, then Power vs. Time from the front panel. When the EMISSion option is selected, the measurement results are equivalent to the results that are displayed by choosing Measurements, then RF Measurements, then Spectrum Emission from the front panel.

Parameter: <char>

Related Command: [:SENSe]:FREQuency

8-3 :DISPlay Subsystem

This subsystem provides commands that modify the display of data for the user. They do not modify the way in which data are returned to the controller.

:DISPlay:WINDow:TRACe:Y[:SCALE]:OFFSet <rel ampl>

:DISPlay:WINDow:TRACe:Y[:SCALE]:OFFSet?

Title: Power Offset

Description: Sets the power offset value for the y-axis.

Parameter: <rel ampl>

Default Value: 0 dB

Default Unit: dB

Range: -100 dB to 100 dB

Front Panel

Access: Amplitude, Power Offset

:DISPlay:WINDow:TRACe:Y[:SCALE]:PDIVision <rel ampl>

:DISPlay:WINDow:TRACe:Y[:SCALE]:PDIVision?

Title: Scale

Description: Sets the scale (dB/division) for the y-axis.

Parameter: <rel ampl>

Default Value: 10 dB/div

Default Unit: dB

Range: 1 dB to 15 dB

Front Panel

Access: Amplitude, Scale/div

8-4 :FETCh Subsystem

This set of commands returns the most recent measurement data of the active measurement. They will not switch to another measurement.

To make a new measurement, use the INITiate command. To get new measurement data, use the READ or MEASure query commands.

:FETCh:DEMod:CDPData?

Title: Fetch Demodulator Code Domain Power Data

Required Option: 43

Description: Returns the most recent Code Domain Data measurement results.

Data is returned as 24 comma-delimited values: Slot Power in dBm, DwPTS Power in dBm, Channel Power RRC in dBm, Freq Error in Hz, Freq Error in PPM, EVM RMS percentage, EVM Peak in percentage, RMS Phase Error in percentage, Carrier Feed Through in dB, DwPTS EVM in percentage, DwPTS PCDE in dB, CDP Noise Floor in dB, CDP Threshold hold in dB, Tau in nanoseconds, Sync DL Code in unitless number, Scrambling Code in unitless number, Max User in unitless number, Spread Factor in dB, Data Modulation Type (0 = Noise, 1 = QPSK, 2 = 8PSK, 3 = 16QAM), Scrambling Code 1 in dB, Scrambling Code 2 in dB, Scrambling Code 3 in dB, and Scrambling Code 4 in dB.

Related Command: :CONFigure:DEMod CDPData
:MEASure:DEMod:CDPData?
:READ:DEMod:CDPData?

Front Panel

Access: Measurements, Demodulator, CDP Data

:FETCh:OTA?

Title: Fetch OTA Pilot Scan

Required Option: 34

Description: Returns the most recent Pilot Scan measurement results.

Data is returned as 2 comma-delimited values: DwPTS Power in dBm, and Pilot Dominance in dBm. All invalid values are replaced with "--".

Related Command: :CONFigure:OTA
:MEASure:OTA?
:READ:OTA?

Front Panel

Access: Measurements, OTA, Pilot Scan

:FETCh:RF:EMISsion?

Title: Fetch RF Spectrum Emission

Required Option: 62

Description: Returns the most recent Spectrum Emission measurement result. Data is returned as 3 comma-delimited values for Left Power, Center Power, and Right Power in dBm. They are followed by 8 comma-delimited values for each marker/boundary: Marker number, Marker Start Frequency in MHz, Marker Stop Frequency in MHz, Marker Peak Power Frequency in MHz, Marker Peak Power in dBm, Marker Power Margin in dB, RBW in MHz, and Pass/Fail.

Related Command: :CONFigure:RF EMISsion
:MEASure:RF:EMISsion?
:READ:RF:EMISsion?

Front Panel

Access: Measurements, RF Measurements, Spectrum Emission

:FETCh:RF:SPECTrum?

Title: Fetch RF Spectrum

Required Option: 42

Description: Returns the most recent RF Channel Spectrum measurement results. Data is returned as 6 comma-delimited values: Channel Power in dBm, Occupied Bandwidth in Hz, Left Channel Power in dBm, Left Channel Occupied Bandwidth in Hz, Right Channel Power in dBm and Right Channel Occupied Bandwidth in Hz.

Related Command: :CONFigure:RF SPECTrum
:MEASure:RF:SPECTrum?
:READ:RF:SPECTrum?

Front Panel

Access: Measurements, RF Measurements, Channel Spectrum

8-5 :FORMat Subsystem

This subsystem contains commands that determine the formatting of numeric data when it is transferred.

The format setting affects data in specific commands only. If a command is affected, it is noted in the command description.

:FORMat[:READings][:DATA] ASCii|INTEger,32|REAL,32

:FORMat[:READings][:DATA]?

Title: Numeric Data Format

Description: This command specifies the format in which data is returned in certain commands.

ASCii format returns the data in comma-separated ASCII format. The units are the current instrument units. This format requires many more bytes so it is the slowest format. INTEger,32 values are signed 32-bit integers in little-endian byte order. This format returns the data in 4-byte blocks. REAL,32 values are 32-bit floating point numbers conforming to the IEEE 754 standard in little-endian byte order. This format returns the data in 4-byte binary format. The units are the current instrument units.

Both INTEger,32 and REAL,32 formats return a definite block length. Each transfer begins with an ASCII header such as #42204. The first digit represents the number of following digits in the header (in this example, 4). The remainder of the header indicates the number of bytes that follow the header (in this example, 2204). You then divide the number of following bytes by the number of bytes in the data format you've chosen (4 for both INTEger,32 and REAL,32) to get the number of data points (in this example, 551).

Parameter: ASCii|INTEger,32|REAL,32

Parameter Type: <char>

Default Value: ASCii

Related Command: :TRACe[:DATA]

8-6 :INITiate Subsystem

This subsystem controls the triggering of measurements.

:INITiate:CONTInuous OFF|ON|0|1

:INITiate:CONTInuous?

Title: Continuous/Single Sweep

Description: Specifies whether the sweep/measurement is triggered continuously. If the value is set to ON or 1, another sweep/measurement is triggered as soon as the current one completes. If continuous is set to OFF or 0, the instrument enters the “idle” state and waits for the :INITiate[:IMMediate] command or for :INITiate:CONTInuous ON. The default value is ON. That is, sending :INIT:CONT is equivalent to sending :INIT:CONT ON. The query version of the command returns a 1 if the instrument is continuously sweeping/measuring and returns a 0 if the instrument is in single sweep/measurement mode. Note that rapid toggling between ON and OFF is not allowed. The instrument must be allowed to make a full sweep before toggling can be done.

Parameter: OFF|ON|0|1

Parameter Type: <boolean>

Default Value: ON

Related Command: :INITiate[:IMMediate]
:INITiate:HOLD

Front Panel

Access: Shift-3 (Sweep), Sweep

:INITiate[:IMMediate]

Title: Trigger Sweep/Measurement

Description: Initiates a sweep/measurement. If :INITiate:CONTInuous is set to ON, this command is ignored. Use this command in combination with :STATus:OPERation? to synchronize the capture of one complete set of data. When this command is sent, the “sweep complete” bit of :STATus:OPERation? is set to 0, indicating that the measurement has not completed. The data collection is then triggered. The controlling program can poll :STATus:OPERation? to determine the status. When the “sweep complete” bit is set to 1, data is ready to be retrieved.

Related Command: :INITiate:CONTInuous
:STATus:OPERation?

Front Panel

Access: Shift-3 (Sweep), Trigger Sweep

8-7 :MEASure Subsystem

These commands take the instrument from its current state, enable the specified measurement and put the instrument into single sweep mode. They correct any parameters that are invalid given the new measurement state such that a valid measurement can take place. Other settings may be changed; see the documentation of CONFigure for each measurement. They then initiate the measurement. When the measurement is complete, they return the result.

To make a measurement with settings other than the “default” measurement settings applied by CONFigure, do the following:

- Send the appropriate CONFigure command to set the desired measurement.
- Modify the settings as required.
- Send the appropriate READ command to measure and return the result.

To get the current measurement data, use the appropriate FETCh command.

:MEASure:DEMod:CDPData?

Title: Measure Demodulator Code Domain Power Data

Required Option: 43

Description: Sets the active measurement to Code Domain Data, sets the default measurement parameters, triggers a new measurement and returns the Slot Power, DwPTS Power, Channel Power RRC, Frequency Error in Hz, Frequency Error in PPM, EVM RMS, EVM Peak, RMS Phase Error, Carrier Feed Through, DwPTS EVM, DwPTS PCDE, CDP Noise Floor, CDP Threshold, Tau, Selected Slot, Sync DL Code, Scrambling Code, Max Users, Spread Factor, Data Modulation Type, Scrambling Code 1, Scrambling Code 2, Scrambling Code 3, and Scrambling Code 4 measurement results. It is a combination of the commands :CONFigure:DEMod CDPower and :READ:DEMod:CDPData? To make a CDP Data measurement with settings other than the default values, send:

```
:CONFigure:DEMod CDPData
Commands to set desired settings
:READ:DEMod:CDPData?
```

Data is returned as 24 comma-delimited values: Slot Power in dBm, DwPTS Power in dBm, Channel Power RRC in dBm, Freq Error in Hz, Freq Error in PPM, EVM RMS percentage, EVM Peak in percentage, RMS Phase Error in percentage, Carrier Feed Through in dB, DwPTS EVM in percentage, DwPTS PCDE in dB, CDP Noise Floor in dB, CDP Threshold hold in dB, Tau in nanoseconds, Sync DL Code in unitless number, Scrambling Code in unitless number, Max User in unitless number, Spread Factor in dB, Data Modulation Type (0 = Noise, 1 = QPSK, 2 = 8PSK, 3 = 16QAM), Scrambling Code 1 in dB, Scrambling Code 2 in dB, Scrambling Code 3 in dB, and Scrambling Code 4 in dB. All invalid values are replaced with "--".

Related Command: :CONFigure:DEMod CDPData
:READ:DEMod:CDPData?
:FETCh:DEMod:CDPData?

Front Panel

Access: Measurements, Demodulator, CDP Data

:MEASure:OTA?

Title: Measure OTA Pilot Scan

Required Option: 33

Description: Sets the active measurement to Pilot Scan, sets the default measurement parameters, triggers a new measurement and returns DwPTS Power and Pilot Dominance. It is a combination of the commands :CONFigure:OTA PSCAn and :READ:OTA? To make an OTA Pilot Scan measurement with settings other than the default values, send:

```
:CONFigure:OTA
Commands to set desired settings
:READ:OTA?
```

Data is returned as 2 comma-delimited values: DwPTS Power in dBm, and Pilot Dominance in dBm. All invalid values are replaced with "--".

Related Command: :CONFigure:OTA
:READ:OTA?
:FETCh:OTA?

Front Panel

Access: Measurements, OTA, Pilot Scan

:MEASure:RF:EMISsion?

Title: Measure RF Spectrum Emission

Required Option: 62

Description: Sets the active measurement to Spectrum Emission, sets the default measurement parameters, triggers a new measurement and returns the Left Power, Center Power, Right Power, followed by Marker Number, Marker Start Frequency, Marker Stop Frequency, Marker Peak Power Frequency, Marker Peak Power, Marker Power Margin, Marker RBW, Marker's Pass/Fail Status for all markers/boundaries. It is a combination of the commands :CONFIgure:RF EMISsion and :READ:RF:EMISsion? To make an RF Spectrum Emission measurement with settings other than the default values, send:

:CONFIgure:RF EMISsion

Commands to set desired settings

:READ:RF:EMISsion?

Data is returned as 3 comma-delimited values for Left Power, Center Power, and Right Power in dBm. They are followed by 8 comma-delimited values for each marker/boundary: Marker number, Marker Start Frequency in MHz, Marker Stop Frequency in MHz, Marker Peak Power Frequency in MHz, Marker Peak Power in dBm, Marker Power Margin in dB, RBW in MHz, and Pass/Fail.

Related Command: :CONFIgure:RF EMISsion
:READ:RF:EMISsion?
:FETCh:RF:EMISsion?

Front Panel

Access: Measurements, RF Measurements, Spectrum Emission

:MEASure:RF:SPECTrum?

Title: Measure RF Spectrum

Required Option: 42

Description: Sets the active measurement to Channel Spectrum, sets the default measurement parameters, triggers a new measurement and returns the Channel Power, Occupied Bandwidth, Left Channel Power, Left Channel Occupied Bandwidth, Right Channel Power and Right Channel Occupied Bandwidth measurement results. It is a combination of the commands :CONFigure:RF SPECTrum and :READ:RF:SPECTrum?

To make an RF Spectrum measurement with settings other than the default values, send:

:CONFigure:RF SPECTrum
Commands to set desired settings
:READ:RF:SPECTrum?

Data is returned as 5 comma-delimited values: Channel Power in dBm, Occupied bandwidth in Hz, Left Channel Power, Left Channel Occupied Bandwidth, Right Channel Power, and Right Channel Occupied Bandwidth.

Related Command: :CONFigure:RF SPECTrum
:READ:RF:SPECTrum?
:FETCh:RF:SPECTrum?

Front Panel

Access: Measurements, RF Measurements, Channel Spectrum

8-8 :MMEMory Subsystem

The Mass Memory subsystem contains functions that provide access to the instrument's setup and data storage.

:MMEMory:DELeTe <filename>

Title: Delete Setup/Measurement

Description: Removes a file specified by <filename> from the current mass storage device. <filename> should be enclosed in either single quotes (') or double quotes (") and it must include the file extension. Use the command MMEMory:MSIS to set the current file location.

Parameter: <filename>

Related Command: :MMEMory:STORE:STATE
:MMEMory:STORE:TRACe
:MMEMory:MSIS INTernal|USB

Front Panel

Access: Shift-7 (File), Delete, Delete Selected File

:MMEMory:LOAD:STATE <integer>,<filename>

Title: Recall Setup

Description: Recalls a previously stored instrument setup in the current save location. The setup file to be loaded is specified by <filename>. <filename> should be enclosed in either single quotes (') or double quotes (") and should contain a file extension ".stp". Use the command MMEMory:MSIS to set the current save location. The <integer> parameter is not currently used, but it must be sent. Send a 1.

Parameter: <integer>, <filename>

Related Command: :MMEMory:STORE:STATE
:MMEMory:MSIS INTernal|USB

Front Panel

Access: Shift-7 (File), Recall

:MMEMory:LOAD:TRACe <integer>,<filename>

Title: Recall Measurement

Description: The instrument must be in the mode of the saved trace in order to recall that trace. Use :INSTrument:SELeCt or :INSTrument:NSELeCt to set the mode. Recalls a previously stored measurement trace from the current save location. The saved measurement trace to be loaded is specified by <filename>. <filename> should be enclosed in either single quotes (') or double quotes (") and should contain a file extension. Note that the trace specified by <filename> should be available at the current save location. Use the command MMEMory:MSIS to set the current save location. The <integer> parameter is not currently used, but it must be sent. Send a 1.

File name extensions:

“.edg” for GSM
 “.spa” for SPA
 “.wcd” for WCDMA
 “.wmxd” for WiMAX
 “.wmxe” for Mobile WiMAX
 “.vna” for Cable & Antenna
 “.cdma” for CDMA
 “.tds” for TDSCDMA
 “.evdo” for EVDO
 “.ia” for Interference Analysis
 “.cs” for Channel Scanner
 “.pm” for Power Meter
 “.tm” for Transmission Measurement
 “.lte” for LTE Analyzer

Note: Extensions not available for T1 and Hi_PM.

Parameter: <integer>, <filename>

Example: To recall trace with file name “trace”:

```
:MMEMory:LOAD:TRACe 1, "trace.spa"
```

Related Command: :MMEMory:STORe:TRACe
 :MMEMory:STORe:TRACe
 :MMEMory:MSIS INTernal|USB

Front Panel

Access: Shift-7 (File), Recall Measurement

:MMEMory:STORe:STATe <integer>, <filename>

Title: Save Setup

Description: Stores the current setup into the file specified by <filename>. <filename> should be enclosed in either single quotes (') or double quotes (") and should not contain a file extension. Use the command MMEMory:MSIS to set the current save location. The <integer> parameter is not currently used, but it must be sent. Send a value of 0.

Parameter: <integer>, <filename>

Related Command: :MMEMory:LOAD:STATe
 :MMEMory:MSIS INTernal|USB

Front Panel

Access: Shift-7 (File)

:MMEMory:STORe:TRACe <integer>,<filename>

Title: Save Measurement

Description: Stores the trace into the file specified by <filename>. <filename> should be enclosed in either single quotes (') or double quotes (" ") and should not contain a file extension. Use the command MMEMory:MSIS to set the current save location. The <integer> parameter is not currently used, but it must be sent. Send a 0. Note that existing files of the same name will not be overwritten.

Parameter: <integer>, <filename>

Example: To save the trace into the file name "trace":

```
:MMEMory:STORe:TRACe 0,"trace"
```

Related Command: :MMEMory:LOAD:TRACe
:MMEMory:MSIS INTernal|USB

Front Panel

Access: Shift-7 (File), Save

8-9 :READ Subsystem

This set of commands combines the ABORt, INITiate and FETCh commands. It aborts any current triggering sequence and sets the trigger state to idle. It then initiates a new active measurement (i.e. begins the collection of new data). When the measurement is complete, it returns the result. These commands will not switch to another measurement.

To get the current measurement data, use the FETCh command.

:READ:DEMod:CDPData?

Title: Read Demodulator Code Domain Data

Required Option: 43

Description: Triggers a new measurement and returns the Slot Power, DwPTS Power, Channel Power RRC, Frequency Error in Hz, Frequency Error in PPM, EVM RMS, EVM Peak, RMS Phase Error, Carrier Feed Through, DwPTS EVM, DwPTS PCDE, CDP Noise Floor, CDP Threshold, Tau, Selected Slot, Sync DL Code, Scrambling Code, Max Users, Spread Factor, Data Modulation Type, Scrambling Code 1, Scrambling Code 2, Scrambling Code 3, and Scrambling Code 4 measurement results. It is a combination of the following commands :ABORt; :INITiate; :FETCh:DEMod:CDPData?

In order for the data to be accurate, the Code Domain Power measurement must be the active measurement (specified by :CONFigure:DEMod CDPData). The current measurement can be queried using :CONFigure?

Data is returned as 24 comma-delimited values: Slot Power in dBm, DwPTS Power in dBm, Channel Power RRC in dBm, Freq Error in Hz, Freq Error in PPM, EVM RMS percentage, EVM Peak in percentage, RMS Phase Error in percentage, Carrier Feed Through in dB, DwPTS EVM in percentage, DwPTS PCDE in dB, CDP Noise Floor in dB, CDP Threshold hold in dB, Tau in nanoseconds, Sync DL Code in unitless number, Scrambling Code in unitless number, Max User in unitless number, Spread Factor in dB, Data Modulation Type (0 = Noise, 1 = QPSK, 2 = 8PSK, 3 = 16QAM), Scrambling Code 1 in dB, Scrambling Code 2 in dB, Scrambling Code 3 in dB, and Scrambling Code 4 in dB. All invalid values are replaced with "--".

Related Command: :CONFigure:DEMod CDPData
:MEASure:DEMod:CDPData?
:FETCh:DEMod:CDPData?

Front Panel

Access: Measurements, Demodulator, CDP Data

:READ:OTA?

Title: Read OTA Pilot Scan

Required Option: 33

Description: Sets the active measurement to Pilot Scan, sets the default measurement parameters, triggers a new measurement and returns DwPTS Power and Pilot Dominance. It is a combination of the commands :ABORT; :INITiate; :FETCh:OTA? In order for the data to be accurate, the Pilot Scan must be the active measurement (specified by :CONFigure:OTA). The current measurement can be queried using :CONFigure?

Data is returned as 2 comma-delimited values: DwPTS Power in dBm, and Pilot Dominance in dBm. All invalid values are replaced with "--".

Related Command: :CONFigure:OTA
:MEASure:OTA?
:FETCh:OTA?

Front Panel

Access: Measurements, OTA, Pilot Scan

:READ:RF:EMISSion?

Title: Read RF Spectrum Emission

Required Option: 62

Description: Triggers a new measurement and returns the Left Power, Center Power, Right Power, followed by Marker Number, Marker Start Frequency, Marker Stop Frequency, Marker Peak Power Frequency, Marker Peak Power, Marker Power Margin, Marker RBW, Marker's Pass/Fail Status for all markers/boundaries markers/boundaries. It is a combination of the commands :ABORT; :INITiate; :FETCh:RF:EMISSion? In order for the data to be accurate, the Spectrum Emission measurement must be the active measurement (specified by :CONFigure:RF EMISSion). The current measurement can be queried using :CONFigure?

Data is returned as 3 comma-delimited values for Left Power, Center Power, and Right Power in dBm. They are followed by 8 comma-delimited values for each marker/boundary: Marker number, Marker Start Frequency in MHz, Marker Stop Frequency in MHz, Marker Peak Power Frequency in MHz, Marker Peak Power in dBm, Marker Power Margin in dB, RBW in MHz, and Pass/Fail.

Related Command: :CONFigure:RF EMISSion
:MEASure:RF:EMISSion?
:FETCh:RF:EMISSion?

Front Panel

Access: Measurements, RF Measurements, Spectrum Emission

:READ:RF:PVTSlot?

Title: Read Power vs. Time

Description: Triggers a new measurement and returns the Channel Power RRC, Sync Download Power, Sync Upload Power, On Off Ratio, Peak Average Ratio, Dw Up Delta, Slot 1 Power, Slot 2 Power, Slot 3 Power, Slot 4 Power, Slot 5 Power, Slot 6 Power, and Slot 7 Power. It is a combination of the commands :CONFigure:RF PVTSlot and :READ:RF:PVTSlot?. To make an RF ACPR measurement with settings other than the default values, send:

:CONFigure:RF PVTSlot

Commands to set desired settings

:READ:RF:PVTSlot?

Data is returned as 13 comma-delimited values: The Channel Power RRC in dBm, Sync Download Power in dBm, Sync Upload Power in dBm, On Off Ratio in dB, Peak Average Ratio in dB, Dw Up Delta in dB, Slot 1 to 7 Power in dBm.

Related Command: :CONFigure:RF PVTSlot
:MEASure:RF:PVTSlot?
:FETCh:RF:PVTSlot?

:READ:RF:SPECTrum?

Title: Read RF Spectrum

Description: Triggers a new measurement and returns the Channel Power, Occupied Bandwidth, Left Channel Power, Left Channel Occupied Bandwidth, Right Channel Power and Right Channel Occupied Bandwidth measurement results. It is a combination of the following commands :ABORt; :INITiate; :FETCh:RF:SPECTrum? In order for the data to be accurate, the Channel Spectrum measurement must be the active measurement (specified by :CONFigure:RF SPECTrum). The current measurement can be queried using :CONFigure?

Data is returned as 6 comma-delimited values: Channel Power in dBm, Occupied bandwidth in Hz, Left Channel Power, Left Channel Occupied Bandwidth, Right Channel Power, and Right Channel Occupied Bandwidth.

Related Command: :FETCh:RF:SPECTrum?
:CONFigure:RF SPECTrum
:MEASure:RF:SPECTrum?

Front Panel

Access: Measurements, RF Measurements, Channel Spectrum

8-10 :TRACe Subsystem

This subsystem contains commands related to the transfer of trace data to and from the instrument.

:TRACe:PREamble? <trace type>

Title: Trace Header Transfer

Description: Returns trace header information for the specified trace. The <trace type> must be one of the following:
SPECTrum | EMISsion | DEMod | OTA | PVTSlot.

Data can be transferred to and from the 5 available display trace types. Use the commands in the MMEMOry subsystem to store and recall traces from the instrument memory. The response begins with an ASCII header. The header specifies the number of following bytes. It looks like #AX, where A is the number of digits in X and X is the number of bytes that follow the header. Parameters are returned in comma-delimited ASCII format. Each parameter is returned as "NAME=VALUE[UNITS]." Valid parameter names are shown in ["TDSCDMA Parameter Names" on page 2-31](#).

Parameter: <trace type>

Related Command: :TRACe:DATA?

:TRACe[:DATA]? <trace type>

Title: Trace Data Transfer

Description: This command transfers trace data from the instrument to the controller. The trace type must be one of the following:
SPECTrum | EMISsion | DEMod | OTA | PVTSlot.

The format of the block data in the query form is specified by :FORMat:DATA. The block data in the command form is always sent in ASCII format. The response begins with an ASCII header that specifies the number of data bytes. It looks like #AX, where A is the number of digits in X and X is the number of bytes that follow the header. Each data point is separated by a comma delimiter. Trace setup information can be acquired using :TRACe[:DATA]:PREamble?. Use the commands in the MMEMory subsystem to store and recall traces from the instrument memory.

The RF measurements Power vs. Time and Channel Spectrum both only have one value per data point that is returned in dBm. Each value is 4 bytes.

For the RF Spectrum Emission measurement, each data point will have two values. The first value is the wave data, while the second value is the mask data. Both values are four bytes and returned in dBm. Note that the second value, which is the mask, may contain default value 300 dBm. This is to signify the mask for the frequency point isn't valid and out of range.

The Demodulator Code Domain Power measurement has six values per data point. The first value is the point number, which has no unit. The second value is the relative power returned in dB of I data. The third value is the absolute power returned in dBm of I data. The fourth value is the relative power returned in dB of Q data. The fifth value is the absolute power returned in dBm of Q data. The sixth value is the type, which is defined in the following table.

Return Value	Signal Type & Color
0	Inactive (appears as gray on the screen)
1	QPSK (appears as orange on the screen)
2	8PSK (appears as purple on the screen)
3	16QAM (appears as brown on the screen)

All values are four bytes each.

Over the Air (OTA) measurements will have three values per data point. The first value is the type, which can be 0 (Noise, Grey), 1 (Primary, Blue), and 2 (Secondary, Red), or. The second value is the Ec/Io returned in dB. The third value is Tau returned in s. All three values are the same and are 4 bytes each.

Note that the instrument must be set in the selected view. Use the CONFIGure command to set the unit to the selected view.

Parameter: <trace type>

Related Command: :FORMat [:DATA]
:TRACe [:DATA]:PREamble?

8-11 :UNIT Subsystem

The unit subsystem is used to modify the default units used for related parameters. These changes affect parameters in both commands and responses.

:UNIT:POWer DBM|W

:UNIT:POWer?

Title: Measurement Units

Description: Sets the default amplitude units for input, output and display.

Parameter: DBM|W

Parameter Type: <char>

Default Value: dBm

Front Panel

Access: Amplitude, Units

8-12 [[:SENSe] Subsystem

The commands in this subsystem relate to device-specific parameters, not signal-oriented parameters.

[[:SENSe]:DEMod:CDPData:UNITs RELative|ABSolute

[[:SENSe]:DEMod:CDPData:UNITs?

Title: Code Domain Data Unit Type

Description: Sets the Code Domain Power unit type. The query form returns either a “REL” for relative units, or an “ABS” for absolute units in Ascii (without the double quotes).

Default Value: RELative

Range: RELative, ABSolute

Front Panel

Access: Measurements, Demodulator, CDP Data, CDP Units

[[:SENSe]:DEMod:MODType Auto|QPSK|8PSK|16QAM

[[:SENSe]:DEMod:MODType?

Title: Modulation Type

Description: This command sets the Data Slot Modulation Type. Options are: auto-detection, assumed QPSK, assumed 8PSK, assumed 16QAM. The query version of this command returns the current setting.

Default Value: Auto

Range: Auto|QPSK|8PSK|16QAM

Front Panel

Access: Setup, More, Modulation Type

[[:SENSe]:DEMod:MUSer Auto|2-16 (even)

[[:SENSe]:DEMod:MUSer?

Title: Max Users

Description: Sets the Walsh codes.

Default Value: Auto

Range: Auto|2 to 16 (even numbers only)

Front Panel

Access: Setup, Max Users

[:SENSE] :DEMod:SCRamblingcode Auto|0-127

[:SENSE] :DEMod:SCRamblingcode?

Title: Scrambling Code

Description: This command sets the Scrambling/Midamble Code of downlink data slot to be demodulated.

Default Value: Auto

Range: Auto|0 to 127

Front Panel

Access: Setup, Scrambling Midamble Code

[:SENSE] :DEMod:SPRFactor Auto|16|1

[:SENSE] :DEMod:SPRFactor?

Title: Spread Factor

Description: This command sets the spreading factor of the downlink data slot to be demodulated.

Default Value: Auto

Range: Auto|16|1

Front Panel

Access: Setup, More, Spreading Factor

[:SENSE] :DWPTs Auto|On|Off

[:SENSE] :DWPTs?

Title: DwPTS

Description: This command sets the Downlink Pilot Time Slot. Options are: auto-detection, assumed ON or assumed OFF.

The query form of this command will returns the current setting.

Default Value: Auto

Range: Auto|On|Off

Front Panel

Access: Setup, More, DwPTS

[:SENSe]:FREQuency:CENTer <freq>

[:SENSe]:FREQuency:CENTer?

Title: Center Frequency

Description: Sets the center frequency. Note that changing the value of the center frequency will change the value of the coupled parameters Start Frequency and Stop Frequency. It may also change the value of the span.

Parameter: <freq>

Default Value: 2.01 GHz

Default Unit: Hz

Range: 1 MHz to 2.7 GHz

Front Panel

Access: Freq, Center Freq

[:SENSe]:FREQuency:SIGStandard:CHANnel <number>

[:SENSe]:FREQuency:SIGStandard:CHANnel?

Title: Channel Selection

Description: Sets the channel number for the selected signal standard.

Parameter: <number>

Front Panel

Access: Freq, Channel

[:SENSe]:FREQuency:SIGStandard:NAME <string>

[:SENSe]:FREQuency:SIGStandard:NAME?

Title: Signal Standard

Description: Selects the desired signal standard from the list. The <string> argument is the name of the desired signal standard as displayed in the instrument's current signal standard list. The list can be displayed on the instrument by choosing the Signal Standard submenu button in the Freq menu. The list can also be downloaded remotely and viewed using Anritsu Master Software Tools. For example, if the desired Signal Standard is P-GSM 900 - Uplink, then the value of the <string> argument would be "P-GSM 900 - Uplink".

The query form of this command will return the name of the currently selected Signal Standard on the list.

Parameter: <string>

Front Panel

Access: Freq, Signal Standard

[:SENSe]:NUMCarriers 1|3

[:SENSe]:NUMCarriers?

Title: Number of Carriers

Description: This command sets the number of main/center TD-SCDMA carriers, for multicarrier configuration. The query version returns the current setting.

Default Value: 1

Range: 1|3

Front Panel

Access: Setup, More, Number of Carriers

[:SENSe]:PFail <test set>

[:SENSe]:PFail?

Title: PASS/FAIL Test Selection

Description: Selects the active test set to be used in subsequent PASS/FAIL measurements. The <test set> value must correspond to a test set that is defined in the test set list. To view the list on the instrument, go into the "Measurement" menu, press the "Pass/Fail Mode" key, and then press the "Select Pass/Fail Test" submenu. Alternatively, the list can be retrieved remotely and viewed using the Anritsu Master Software Tools. The <test set> argument is a 1-based index of the position of the desired Pass/Fail test set in the instrument's current Pass/Fail test set list. For example, if the desired Pass/Fail test is the 3rd item on the list, then the value of the <test set> argument would be 3.

When using the query form of the command, the return value is the currently selected test set number. If there is not a valid test set selected, the return value is "-1" (negative 1).

Parameter: <test set>

Related Command: :CONFigure PFail

Front Panel

Access: Measurements, Pass Fail/Mode, Select Pass/Fail Test

[:SENSe]:POWer[:RF]:RANGe:AUTO OFF|ON|0|1

[:SENSe]:POWer[:RF]:RANGe:AUTO?

Title: Automatic Amplitude Range

Description: Sets the automatic amplitude range. Setting the value to ON or 1 will result in the amplitude range being coupled to the detected input signal level. Setting the value to OFF or 0 will result in the input attenuation being un-coupled from the input signal level. That is, changing the input signal level will not change the amplitude range. When this command is issued, the amplitude range itself will not change. The default value is ON. That is, sending :SENS:POW:RANG:AUTO is equivalent to sending :SENS:POW:RANG:AUTO ON.

Parameter: OFF|ON|0|1

Parameter Type: <boolean>

Default Value: ON

Related Command: [:SENSe]:POWer[:RF]:RANGe

Front Panel

Access: Amplitude, Auto Range

[:SENSe]:POWer[:RF]:RANGe[:IMMediate]

Title: Amplitude Range

Description: Re-calculates amplitude range. Note that issuing this command will set the automatic dynamic range OFF.

Related Command: [:SENSe]:POWer[:RF]:RANGe:AUTO

Front Panel

Access: Amplitude, Adjust Range

[:SENSe]:SLOTselection Auto|0-6

[:SENSe]:SLOTselection?

Title: Slot Selection

Description: Sets the Walsh codes.

Default Value: Auto (7)

Range: Auto, 0 to 6

Front Panel

Access: Setup, Slot Selection

[:SENSE]:SWEep:SPEed FAST|NORM|SLOW

[:SENSE]:SWEep:SPEed?

Title: Measurement Speed

Description: Sets the measurement speed. The query form returns either "FAST", "NORM", or "SLOW" in Ascii (without the double quotes).

Parameter: FAST|NORM|SLOW

Parameter Type: <char>

Default Value: Norm

Range: FAST, NORM, SLOW

Front Panel

Access: Setup, Meas Speed

[:SENSE]:SYDLcode Auto|0-31

[:SENSE]:SYDLcode?

Title: Sync-DL Code

Description: This command sets the Sync-DL code of the Downlink Pilot Time Slot used in subframe sync.

Default Value: Auto (32)

Range: Auto, 0 to 31

Front Panel

Access: Setup, SYNC-DL Code

[:SENSE]:TAU:OFFSet <integer>

[:SENSE]:TAU:OFFSet?

Title: Tau Offset

Description: Sets the Tau offset in microsecond.

Default Value: 0

Range: -5000000 to 5000000

Front Panel

Access: Setup, Trigger, Tau Offset

[:SENSe]:TRIGger NOTRig|GPS|EXT

[:SENSe]:TRIGger?

Title: External Trigger

Description: Sets the external trigger. The query form returns either "NOTRIG", "GPS", or "EXT" in Ascii (without the double quotes).

Default Value: No Trig

Range: NOTRig, GPS, EXT

Front Panel

Access: Setup, Trigger, Trigger Type

[:SENSe]:ULSWitchpoint 0-6

[:SENSe]:ULSWitchpoint?

Title: Uplink Switch Point

Description: Index of the the last downlink slot in the subframe.

Default Value: 3

Range: 0 to 6

Front Panel

Access: Setup, Uplink Switch Point

Chapter 9 — CDMA Commands

9-1 :ABORt Subsystem

The abort subsystem includes commands that allow the user to stop current measurement activities on the instrument.

:ABORt

Title: Abort

Description: Restarts the current sweep and/or measurement. Resets the trigger system. If :INITiate:CONTinuous is OFF (i.e. the instrument is in single sweep mode), send the command :INITiate[:IMMediate] to trigger the next sweep. If :INITiate:CONTinuous is ON (i.e. the instrument is in continuous sweep mode), a new sweep will start immediately.

Parameter: NA

Related Command: :INITiate:CONTinuous
:INITiate[:IMMediate]

9-2 :CALCulate Subsystem

The commands in this subsystem process data that has been collected via the CALCulate subsystem. Valid measurements with the use of markers are RF Measurement - Channel Spectrum and the Demodulator Measurement - CDP.

:CALCulate:MARKer:AOff

Title: Turn All Markers Off

Description: Turns off all markers.

Front Panel

Access: Marker, All Markers Off

:CALCulate:MARKer{1|2|3|4|5|6}:Y?

Title: Marker Read Y Value

Description: Reads the current Y value for the specified marker. The units are the units of the y-axis.

Default Unit: Current y-axis unit

:CALCulate:MARKer{1|2|3|4|5|6}[:STATe] OFF|ON|0|1

:CALCulate:MARKer{1|2|3|4|5|6}[:STATe]?

Title: Marker State

Description: Sets the specified marker on/off.

Parameter: OFF|ON|0|1

Parameter Type: <boolean>

Default Value: OFF

Example: To turn off reference marker #1:

```
:CALCulate:MARKer1:STATe OFF
```

Front Panel

Access: Marker, On/Off

9-3 :CONFigure Subsystem

This set of commands prepares the instrument for the selected measurement. It disables any currently-enabled measurements and activates the specified measurement. It sets the instrument to single sweep mode, waiting for an :INITiate command. It will not initiate the taking of a measurement.

Current instrument settings may be changed to default values. These changes are identified with their respective measurement commands.

:CONFigure SUMMary|PFail

Title: Configure Summary and Pass/Fail Measurements

Description: This command configures the summary and PASS/FAIL measurements. It disables any other active measurements. None of the instrument parameters are changed by the execution of this command. Sets the instrument to single sweep mode (:INITiate:CONTInuous OFF). Measurement settings can be modified by using the [:SENSE] commands before initiating a measurement.

Parameter: SUMMary|PFail

Parameter Type: <char>

Front Panel

Access: Measurements, CDMA Summary or Pass/Fail Mode

:CONFigure:DEMod <char>

Title: Configure Demodulation Measurement

Required Option: 43

Description: Valid <char> parameter options: SUMMary|CDPower|CDPTable

This command configures the selected demodulation measurement. It disables any other active measurements. Sets the instrument to single sweep mode (:INITiate:CONTInuous OFF). Measurement settings can be modified by using the [:SENSE]:DEMod commands before initiating a measurement.

When the SUMMARY option is selected, the measurement results are equivalent to the results that are displayed by choosing Measurements, then Demodulator, then Modulation Summary from the front panel.

When the CDPower option is selected, the measurement results are equivalent to the results that are displayed by choosing Measurements, then Demodulator, then CDP from the front panel. When the CDPTable option is selected, the measurement results are equivalent to the results that are displayed by choosing Measurements, then Demodulator, then CDP Table from the front panel.

Parameter: <char>

Front Panel

Access: Measurements, Demodulator

:CONFigure:OTA <char>

Title: Configure Over-The-Air Measurement

Required Option: 33

Description: Valid parameter options: PSCAn | MPATh. This command configures the selected Over The Air measurement. It disables any other active measurements. Sets the instrument to single sweep mode (:INITiate:CONTInuous OFF). Measurement settings can be modified before initiating a measurement. When the PSCAn option is selected, the measurement results are equivalent to the results that are displayed by choosing Measurements, then OTA, then Pilot Scan from the front panel. When the MPATh option is selected, the measurement results are equivalent to the results that are displayed by choosing Measurements, then OTA, then Multipath from the front panel.

Parameter: <char>

:CONFigure:RF <char>

Title: Configure RF Measurement

Required Option: 42

Description: Valid parameter options: SUMMary | SPECTrum | ACPR | EMISsion
This command configures the selected RF measurement. It disables any other active measurements. Sets the instrument to single sweep mode (:INITiate:CONTInuous OFF). Measurement settings can be modified by using the [:SENSe]:RF commands before initiating a measurement.
When the SUMMary option is selected, the measurement results are equivalent to the results that are displayed by choosing Measurements, then RF, then RF Summary from the front panel. When the SPECTrum option is selected, the measurement results are equivalent to the results that are displayed by choosing Measurements, then RF, then Channel Spectrum from the front panel. When the ACPR option is selected, the measurement results are equivalent to the results that are displayed by choosing Measurements, then RF, then ACPR from the front panel. When the EMISsion option is selected, the measurement results are equivalent to the results that are displayed by choosing Measurements, then RF Measurements, then Spurious Emission from the front panel.

Parameter: <char>

Related Command: [:SENSe]:FREQuency

9-4 :DISPlay Subsystem

This subsystem provides commands that modify the display of data for the user. They do not modify the way in which data are returned to the controller.

:DISPlay:WINDow:TRACe:Y[:SCALE]:OFFSet <rel ampl>

:DISPlay:WINDow:TRACe:Y[:SCALE]:OFFSet?

Title: Power Offset

Description: Sets the power offset value for the y-axis.

Parameter: <rel ampl>

Default Value: 0 dB

Default Unit: dB

Range: -100 dB to 100 dB

Front Panel

Access: Amplitude, Power Offset

:DISPlay:WINDow:TRACe:Y[:SCALE]:PDIVision <rel ampl>

:DISPlay:WINDow:TRACe:Y[:SCALE]:PDIVision?

Title: Scale

Description: Sets the scale (dB/division) for the y-axis.

Parameter: <rel ampl>

Default Value: 10 dB/div

Default Unit: dB

Range: 1 dB to 15 dB

Front Panel

Access: Amplitude, Scale/div

9-5 :FETCh Subsystem

This set of commands returns the most recent measurement data of the active measurement. They will not switch to another measurement.

To make a new measurement, use the INITiate command. To get new measurement data, use the READ or MEASure query commands.

:FETCh:DEMod:CDPower?

Title: Fetch Demodulated Channel Power

Required Option: 43

Description: Returns the most recent Code Domain Power measurement results.

Data is returned as 12 comma-delimited values: Pilot Power in the current user set unit (dBm/W/mW), Channel Power in the current user set unit (dBm/W/mW), Noise Floor in dB, Rho, Carrier Feed Through in dB, Tau in ps, RMS Phase Error in deg, Frequency Error in Hz, Frequency Error PPM, Page in dBm, Sync in dBm, and Q Page. All invalid values are replaced with "--".

Default Unit: dBm

Related Command: :CONFigure:DEMod CDPower
:MEASure:DEMod:CDPower?
:READ:DEMod:CDPower?

Front Panel

Access: Measurements, Demodulator, CDP

:FETCh:OTA:MPATH?

Title: Fetch OTA Multipath

Required Option: 33

Description: Returns the most recent Multipath measurement results.

Data is returned as 14 comma-delimited values: six Ec/Io Values in dB, six Tau values in ps, Channel Power in the current user set unit (dBm/W/mW), and Multipath Power in dB. All invalid values are replaced with "--".

Related Command: :CONFigure:OTA MPATH
:MEASure:OTA:MPATH?
:READ:OTA:MPATH?

Front Panel

Access: Measurements, OTA, Multipath

:FETCh:PFail?

Title: Fetch PASS/FAIL

Description: Returns the most recent PASS/FAIL measurement results. Measurement results are returned in a block of ASCII text in the format of <header><block>. The ASCII header specifies the number of data bytes. It looks like #AX, where A is the number of digits in X and X is the number of bytes in the <block>. The block consists of a set of records which indicate individual test results. Records are comma-separated. Each record follows the format <test ID>: <input1> <input2> <min> <max> <value1> <value2> <PASS/FAIL/OPTION NOT INSTALLED>. The <test ID> field indicates which test was performed to retrieve these results. The <input1> and <input2> fields indicate the test setup. The <min> and <max> fields indicate the minimum and maximum values against which <value1> and <value2> were compared to arrive at the final PASS/FAIL result. If the specified test is not available in the instrument, the <PASS/FAIL> field will indicate "option not available" instead of "pass" or "fail". All unused fields for a given test are represented by a double dash ("--"). To receive valid measurements, the Pass/Fail measurement must be the active. The current measurement can be queried using CONFigure?. Use the :CONFigure PFail command to set Pass/Fail as the active measurement.

Related Command: MEASure:PFail?
:CONFigure PFail
READ:PFail?

:FETCh:RF:ACPR?

Title: Fetch Adjacent Channel Power Ratio

Required Option: 42

Description: Returns the most recent Adjacent Channel Power Ratio measurement results.

Data is returned as 9 comma-delimited values: The Absolute Adjacent Channel 1 Power, Absolute Adjacent Channel 2 Power, Absolute Main Channel 1 Power, Absolute Main Channel 2 Power, Absolute Main Channel 3 Power, Absolute Main Channel 4 Power, Absolute Main Channel 5 Power, Absolute Adjacent Channel 3 Power, Absolute Adjacent Channel 4 Power. All values are returned in dBm. Note that the values for all five main channel carriers are shown even if the number of carriers set on the instrument is below five.

Related Command: :CONFigure:RF ACPR
:MEASure:RF:ACPR?
:READ:RF:ACPR?

Front Panel

Access: Measurements, RF Measurements, ACPR

:FETCh:RF:EMISsion?

Title: Fetch RF Spurious Emission

Required Option: 42

Description: Returns the most recent Spurious Emission measurement result. Data is returned as 5 comma-delimited values for each marker/boundary (40 values total): Marker Amplitude in dB, Marker Frequency in Hz, RBW in Hz, Pass/Fail, and Mask Boundary Frequency in Hz. Markers that are not on will return "--" for Marker Amplitude, Marker Frequency, RBW, and Pass/Fail. All Mask Boundary Frequencies will show normally.

Related Command: :CONFIgure:RF EMISsion
:MEASure:RF:EMISsion?
:READ:RF:EMISsion?

Front Panel

Access: Measurements, RF Measurements, Spurious Emission

:FETCh:RF:SPECTrum?

Title: Fetch RF Spectrum

Required Option: 42

Description: Returns the most recent RF Channel Spectrum measurement results. Data is returned as 4 comma-delimited values: Channel Power in the current user set unit (dBm/W/mW), Occupied bandwidth in Hz, Channel Power in fW, and Peak to Average Power in dB.

Related Command: :CONFIgure:RF SPECTrum
:MEASure:RF:SPECTrum?
:READ:RF:SPECTrum?

Front Panel

Access: Measurements, RF Measurements, Channel Spectrum

9-6 :FORMat Subsystem

This subsystem contains commands that determine the formatting of numeric data when it is transferred.

The format setting affects data in specific commands only. If a command is affected, it is noted in the command description.

:FORMat[:READings][:DATA] ASCii|INTEger,32|REAL,32

:FORMat[:READings][:DATA]?

Title: Numeric Data Format

Description: This command specifies the format in which data is returned in certain commands.

ASCii format returns the data in comma-separated ASCII format. The units are the current instrument units. This format requires many more bytes so it is the slowest format. INTEger 32 values are signed 32-bit integers in little-endian byte order. This format returns the data in 4-byte blocks.

Both INTEger,32 and REAL,32 formats return a definite block length. Each transfer begins with an ASCII header such as #42204. The first digit represents the number of following digits in the header (in this example, 4). The remainder of the header indicates the number of bytes that follow the header (in this example, 2204). You then divide the number of following bytes by the number of bytes in the data format you've chosen (4 for both INTEger,32 and REAL,32) to get the number of data points (in this example, 551).

Parameter: ASCii|INTEger,32|REAL,32

Parameter Type: <char>

Default Value: ASCii

Related Command: :TRACe[:DATA]

9-7 :INITiate Subsystem

This subsystem controls the triggering of measurements.

:INITiate:CONTInuous OFF|ON|0|1

:INITiate:CONTInuous?

Title: Continuous/Single Sweep

Description: Specifies whether the sweep/measurement is triggered continuously. If the value is set to ON or 1, another sweep/measurement is triggered as soon as the current one completes. If continuous is set to OFF or 0, the instrument enters the “idle” state and waits for the :INITiate[:IMMEDIATE] command or for :INITiate:CONTInuous ON. The default value is ON. That is, sending :INIT:CONT is equivalent to sending :INIT:CONT ON. The query version of the command returns a 1 if the instrument is continuously sweeping/measuring and returns a 0 if the instrument is in single sweep/measurement mode. Note that rapid toggling between ON and OFF is not allowed. The instrument must be allowed to make a full sweep before toggling can be done.

Note: Issue the command :INITiate[:IMMEDIATE] after changing from single sweep mode to continuous sweep mode in order to begin sweeping.

Parameter: OFF|ON|0|1

Parameter Type: <boolean>

Default Value: ON

Related Command: :INITiate[:IMMEDIATE]
:INITiate:HOLD

Front Panel

Access: Shift-3 (Sweep), Sweep

:INITiate[:IMMEDIATE]

Title: Trigger Sweep/Measurement

Description: Use this command in combination with :STATus:OPERation? to synchronize the capture of one complete set of data. When this command is sent, the “sweep complete” bit of :STATus:OPERation? is set to 0, indicating that the measurement has not completed. The data collection is then triggered. The controlling program can poll :STATus:OPERation? to determine the status. When the “sweep complete” bit is set to 1, data is ready to be retrieved.

Related Command: :INITiate:CONTInuous
:STATus:OPERation?

Front Panel

Access: Shift-3 (Sweep), Trigger Sweep

9-8 :MEASure Subsystem

These commands take the instrument from its current state, enable the specified measurement and put the instrument into single sweep mode. They correct any parameters that are invalid given the new measurement state such that a valid measurement can take place. Other settings may be changed; see the documentation of CONFigure for each measurement. They then initiate the measurement. When the measurement is complete, they return the result.

To make a measurement with settings other than the “default” measurement settings applied by CONFigure, do the following:

- Send the appropriate CONFigure command to set the desired measurement.
- Modify the settings as required.
- Send the appropriate READ command to measure and return the result.

To get the current measurement data, use the appropriate FETCh command.

:MEASure:DEMod:CDPower?

Title: Measure Code Domain Power

Required Option: 43

Description: Sets the active measurement to Code Domain Power, sets the default measurement parameters, triggers a new measurement and returns the Pilot Power, Channel Power, Noise Floor, Rho, Carrier Feed Through, Tau, RMS Phase Error, Frequency Error, Frequency Error PPM, Page, Sync, and Q Page measurement results. It is a combination of the commands :CONFigure:DEMod CDPower and :READ:DEMod:CDPower? To make a CDP measurement with settings other than the default values, send:

```
:CONFigure:DEMod CDPower
Commands to set desired settings
:READ:DEMod:CDPower?
```

Data is returned as 12 comma-delimited values: Pilot Power in the current user set unit (dBm/W/mW), Channel Power in the current user set unit (dBm/W/mW), Noise Floor in dB, Rho, Carrier Feed Through in dB, Tau in ps, RMS Phase Error in deg, Frequency Error in Hz, Frequency Error PPM, Page in dBm, Sync in dBm, and Q Page. All invalid values are replaced with “-”.

Default Unit: dBm

Related Command: :CONFigure:DEMod CDPower
:READ:DEMod:CDPower?
FETCh:DEMod:CDPower?

:MEASure:OTA:MPATH?

Title: Measure OTA Multipath

Required Option: 33

Description: Sets the active measurement to Multipath, sets the default measurement parameters, triggers a new measurement and returns six Ec/Io values, six Tau values, Channel Power, and Multipath Power. It is a combination of the commands :CONFigure:OTA MPATH and :READ:OTA:MPATH?. To make an OTA Multipath measurement with settings other than the default values, send:

```
:CONFigure:OTA MPATH
Commands to set desired settings
:READ:OTA:MPATH?
```

Data is returned as 14 comma-delimited values: six Ec/Io Values in dB, six Tau values in ps, Channel Power in the current user set unit (dBm/W/mW), and Multipath Power in dB. All invalid values are replaced with "--".

Related Command: :CONFigure:OTA MPATH
:READ:OTA:MPATH?
:FETCh:OTA:MPATH?

Front Panel

Access: Measurements, OTA, Multipath

:MEASure:PFail?

Title: Measure PASS/FAIL

Description: Sets the active measurement to PASS/FAIL, sets the default measurement parameters, triggers a new measurement and returns the PASS/FAIL results. It is a combination of the commands :CONFigure PFail and :READ:PFail?. To make a PASS/FAIL measurement with settings other than the default values, send:

```
:CONFigure PFail
Commands to set desired settings
:READ:PFail?
```

Related Command: :CONFigure PFail
READ:PFail?
FETCh:PFail?

Front Panel

Access: Measurements, Pass/Fail Mode

:MEASure:RF:ACPR?

Title: Measure Adjacent Channel Power Ratio

Required Option: 42

Description: Sets the active measurement to ACPR, sets the default measurement parameters, triggers a new measurement, and returns the power levels for each of the adjacent and main channels (9 total). It is a combination of the commands :CONFigure:RF ACPR and :READ:RF:ACPR? To make an RF ACPR measurement with settings other than the default values, send:

:CONFigure:RF ACPR

Commands to set desired settings

:READ:RF:ACPR?

Data is returned as 9 comma-delimited values: The Absolute Adjacent Channel 1 Power, Absolute Adjacent Channel 2 Power, Absolute Main Channel 1 Power, Absolute Main Channel 2 Power, Absolute Main Channel 3 Power, Absolute Main Channel 4 Power, Absolute Main Channel 5 Power, Absolute Adjacent Channel 3 Power, Absolute Adjacent Channel 4 Power. All values are returned in dBm.

Note that the values for all five main channel carriers are shown even if the number of carriers set on the instrument is below five.

Related Command: :READ:RF:ACPR?
:CONFigure:RF ACPR
:FETCh:RF:ACPR?

Front Panel

Access: Measurements, RF Measurements, ACPR

:MEASure:RF:EMISsion?

Title: Measure RF Spurious Emission

Required Option: 42

Description: Sets the active measurement to Spurious Emission, sets the default measurement parameters, triggers a new measurement and returns the Marker Amplitude, Marker Frequency, RBW, a Pass/Fail assessment, and the Mask Boundary Frequency for all markers/boundaries. It is a combination of the commands :CONFigure:RF EMISsion and :READ:RF:EMISsion? To make an RF Spurious Emission measurement with settings other than the default values, send:

:CONFigure:RF EMISsion

Commands to set desired settings

:READ:RF:EMISsion?

Data is returned as 5 comma-delimited values for each marker/boundary: Marker Amplitude in dB, Marker Frequency in Hz, RBW in Hz, Pass/Fail, and Mask Boundary Frequency in Hz.

Markers that are not on will return "--" for Marker Amplitude, Marker Frequency, RBW, and Pass/Fail. Mask Boundary Frequency will show normally despite the corresponding marker being off.

Related Command: :CONFIgure:RF EMISsion
:READ:RF:EMISsion?
:FETCh:RF:EMISsion?

Front Panel

Access: Measurements, RF Measurements, Spurious Emission

:MEASure:RF:SPECTrum?

Title: Measure RF Spectrum

Required Option: 42

Description: Sets the active measurement to Channel Spectrum, sets the default measurement parameters, triggers a new measurement and returns the Channel Power (Current User Set Unit), Occupied Bandwidth, Channel Power (Watts) and Peak to Average Power measurement results. It is a combination of the commands :CONFigure:RF SPECTrum and :READ:RF:SPECTrum? To make an RF Spectrum measurement with settings other than the default values, send:

:CONFigure:RF SPECTrum

Commands to set desired settings

:READ:RF:SPECTrum?

Data is returned as 4 comma-delimited values: Channel Power in the current user set unit (dBm/W/mW), Occupied bandwidth in Hz, Channel Power in fW, and Peak to Average Power in dB.

Related Command: :CONFigure:RF SPECTrum
:READ:RF:SPECTrum?
:FETCh:RF:SPECTrum?

Front Panel

Access: Measurements, RF Measurements, Channel Spectrum

9-9 :MMEMory Subsystem

The Mass Memory subsystem contains functions that provide access to the instrument's setup and data storage.

:MMEMory:DELeTe <filename>

Title: Delete Setup/Measurement

Description: Removes a file specified by <filename> from the current mass storage device. <filename> should be enclosed in either single quotes (') or double quotes (" ") and it must include the file extension. Use the command MMEMory:MSIS to set the current file location.

Parameter: <filename>

Related Command: :MMEMory:STORe:STATe
:MMEMory:STORe:TRACe
:MMEMory:MSIS INTernal|USB

Front Panel

Access: Shift-7 (File), Delete, Delete Selected File

:MMEMory:LOAD:STATe <integer>,<filename>

Title: Recall Setup

Description: Recalls a previously stored instrument setup in the current save location. The setup file to be loaded is specified by <filename>. <filename> should be enclosed in either single quotes (') or double quotes (" ") and should contain a file extension ".stp". Use the command MMEMory:MSIS to set the current save location. The <integer> parameter is not currently used, but it must be sent. Send a 1.

Parameter: <integer>, <filename>

Related Command: :MMEMory:STORe:STATe
:MMEMory:MSIS INTernal|USB

Front Panel

Access: Shift-7 (File), Recall

:MMEMory:LOAD:TRACe <integer>,<filename>

Title: Recall Measurement

Description: The instrument must be in the mode of the saved trace in order to recall that trace. Use :INSTRument:SELeCt or :INSTRument:NSELeCt to set the mode. Recalls a previously stored measurement trace from the current save location. The saved measurement trace to be loaded is specified by <filename>. <filename> should be enclosed in either single quotes (') or double quotes (" ") and should contain a file extension. Note that the trace specified by <filename> should be available at the current save location. Use the command MMEMory:MSIS to set the current save location. The <integer> parameter is not currently used, but it must be sent. Send a 1.

File name extensions:

“.edg” for GSM
 “.spa” for SPA
 “.wcd” for WCDMA
 “.wmx” for WiMAX
 “.wmx” for Mobile WiMAX
 “.vna” for Cable & Antenna
 “.cdma” for CDMA
 “.tds” for TDSCDMA
 “.evdo” for EVDO
 “.ia” for Interference Analysis
 “.cs” for Channel Scanner
 “.pm” for Power Meter
 “.tm” for Transmission Measurement
 “.lte” for LTE Analyzer

Note: Extensions not available for T1 and Hi_PM.

Parameter: <integer>, <filename>

Example: To recall trace with file name “trace”:

```
:MMEMory:LOAD:TRACe 1,"trace.spa"
```

Related Command: :MMEMory:STORe:TRACe
 :MMEMory:STORe:TRACe
 :MMEMory:MSIS INTernal|USB

Front Panel

Access: Shift-7 (File), Recall Measurement

:MMEMory:STORe:STATe <integer>,<filename>

Title: Save Setup

Description: Stores the current setup into the file specified by <filename>. <filename> should be enclosed in either single quotes (') or double quotes (") and should not contain a file extension. Use the command MMEMory:MSIS to set the current save location. The <integer> parameter is not currently used, but it must be sent. Send a value of 0.

Parameter: <integer>, <filename>

Related Command: :MMEMory:LOAD:STATe
 :MMEMory:MSIS INTernal|USB

Front Panel

Access: Shift-7 (File)

:MMEMory:STORe:TRACe <integer>,<filename>

Title: Save Measurement

Description: Stores the trace into the file specified by <filename>. <filename> should be enclosed in either single quotes (' ') or double quotes (" ") and should not contain a file extension. Use the command MMEMory:MSIS to set the current save location. The <integer> parameter is not currently used, but it must be sent. Send a 0. Note that existing files of the same name will not be overwritten.

Parameter: <integer>, <filename>

Example: To save the trace into the file name "trace":

```
:MMEMory:STORe:TRACe 0,"trace"
```

Related Command: :MMEMory:LOAD:TRACe
:MMEMory:MSIS INTernal|USB

Front Panel

Access: Shift-7 (File), Save

9-10 :READ Subsystem

This set of commands combines the ABORt, INITiate and FETCh commands. It aborts any current triggering sequence and sets the trigger state to idle. It then initiates a new active measurement (i.e. begins the collection of new data). When the measurement is complete, it returns the result. These commands will not switch to another measurement.

To get the current measurement data, use the FETCh command.

:READ:DEMod:CDPower?

Title: Read Code Domain Power

Required Option: 43

Description: Triggers a new measurement and returns the Pilot Power, Channel Power, Noise Floor, Rho, Carrier Feed Through, Tau, RMS Phase Error, Frequency Error, Frequency Error PPM, Page, Sync, and Q Page measurement results. It is a combination of the following commands :ABORt; :INITiate; :FETCh:DEMod:CDPower? In order for the data to be accurate, the Code Domain Power measurement must be the active measurement (specified by :CONFigure:DEMod CDPower). The current measurement can be queried using :CONFigure?

Data is returned as 12 comma-delimited values: Pilot Power in the current user set unit (dBm/W/mW), Channel Power in the current user set unit (dBm/W/mW), Noise Floor in dB, Rho, Carrier Feed Through in dB, Tau in ps, RMS Phase Error in deg, Frequency Error in Hz, Frequency Error PPM, Page in dBm, Sync in dBm, and Q Page. All invalid values are replaced with "--".

Default Unit: dBm

Related Command: CONFigure:DEMod CDPower
:MEASure:DEMod:CDPower?
:FETCh:DEMod:CDPower?

Front Panel

Access: Measurements, Demodulator, CDP

:READ:OTA:MPATH?

Title: Read OTA Multipath

Required Option: 33

Description: Triggers a new measurement and returns six Ec/Io values, six Tau values, Channel Power, and Multipath Power. It is a combination of the following commands :ABORt; :INITiate; :FETCh:OTA:MPATH? In order for the data to be accurate, the Multipath measurement must be the active measurement (specified by :CONFigure:OTA MPATH). The current measurement can be queried using :CONFigure?

Data is returned as 14 comma-delimited values: six Ec/Io Values in dB, six Tau values in ps, Channel Power in the current user set unit (dBm/W/mW), and Multipath Power in dB. All invalid values are replaced with "--".

Related Command: :CONFigure:OTA MPATH
:MEASure:OTA:MPATH?
:FETCh:OTA:MPATH?

Front Panel

Access: Measurements, OTA, Multipath

:READ:PFail?

Title: Read PASS/FAIL

Description: Triggers a new PASS/FAIL measurement and returns the results. It is a combination of the commands :ABORT; :INITiate; :FETCh:PFail? The PASS/FAIL measurement must be active. The current measurement can be queried using :CONFigure?

Related Command: :FETCh:PFail?
:CONFigure PFail
:MEASure:PFail?

Front Panel

Access: Measurements, Pass/Fail Mode

:READ:RF:ACPR?

Title: Read Adjacent Channel Power Ratio

Required Option: 42

Description: Triggers a new measurement, and returns the power levels for each of the adjacent and main channels (9 total). It is a combination of the commands :ABORT; :INITiate; :FETCh:RF:ACPR? In order for the data to be accurate, the ACPR measurement must be the active measurement (specified by :CONFigure:RF ACPR). The current measurement can be queried using :CONFigure?

Data is returned as 9 comma-delimited values: The Absolute Adjacent Channel 1 Power, Absolute Adjacent Channel 2 Power, Absolute Main Channel 1 Power, Absolute Main Channel 2 Power, Absolute Main Channel 3 Power, Absolute Main Channel 4 Power, Absolute Main Channel 5 Power, Absolute Adjacent Channel 3 Power, Absolute Adjacent Channel 4 Power. All values are returned in dBm. Note that the values for all five main channel carriers are shown even if the number of carriers set on the instrument is below five.

Related Command: :FETCh:RF:ACPR?
:CONFigure:RF ACPR
:MEASure:RF:ACPR?

Front Panel

Access: Measurements, RF Measurements, ACPR

:READ:RF:EMISsion?

Title: Read RF Spurious Emission

Required Option: 42

Description: Triggers a new measurement and returns the Marker Amplitude, Marker Frequency, RBW, a Pass/Fail assessment, and the Mask Boundary Frequency for all markers/boundaries. It is a combination of the following commands :ABORt; :INITiate; :FETCh:RF:EMISsion? In order for the data to be valid, the Spurious Emission measurement must be the active measurement (specified by :CONFigure:RF EMISsion). The current measurement can be queried using :CONFigure?

Data is returned as 5 comma-delimited values for each marker/boundary (40 values total): Marker Amplitude in dB, Marker Frequency in Hz, RBW in Hz, Pass/Fail, and Mask Boundary Frequency in Hz. Markers that are not on will return "--" for Marker Amplitude, Marker Frequency, RBW, and Pass/Fail. All Mask Boundary Frequencies will show normally.

Related Command: :CONFigure:RF EMISsion
:MEASure:RF:EMISsion?
:FETCh:RF:EMISsion?

Front Panel

Access: Measurements, RF Measurements, Spurious Emission

:READ:RF:SPECTrum?

Title: Read RF Spectrum

Required Option: 42

Description: Triggers a new measurement and returns the Channel Power (Current User Set Unit), Occupied Bandwidth, Channel Power (Watts) and Peak to Average Power measurement results. It is a combination of the following commands :ABORt; :INITiate; :FETCh:RF:SPECTrum? In order for the data to be accurate, the Channel Spectrum measurement must be the active measurement (specified by :CONFigure:RF SPECTrum). The current measurement can be queried using :CONFigure?

Data is returned as 4 comma-delimited values: Channel Power in the current user set unit (dBm/W/mW), Occupied bandwidth in Hz, Channel Power in fW, and Peak to Average Power in dB.

Related Command: :FETCh:RF:SPECTrum?
:CONFigure:RF SPECTrum
:MEASure:RF:SPECTrum?

Front Panel

Access: Measurements, RF Measurements, Channel Spectrum

9-11 :TRACe Subsystem

This subsystem contains commands related to the transfer of trace data to and from the instrument.

:TRACe:PREamble? <trace type>

Title: Trace Header Transfer

Description: Returns trace header information for the specified trace. The <trace type> must be one of the following:
SPECtrum | EMISsion | DEMod | PSCAn | MPATh.

Data can be transferred to and from the 5 available display trace types. Use the commands in the MMEMory subsystem to store and recall traces from the instrument memory. The response begins with an ASCII header. The header specifies the number of following bytes. It looks like #AX, where A is the number of digits in X and X is the number of bytes that follow the header. Parameters are returned in comma-delimited ASCII format. Each parameter is returned as "NAME=VALUE[UNITS]," Valid parameter names are shown in "[CDMA Parameter Names](#)" on page 2-27.

Parameter: <trace type>

Related Command: :TRACe:DATA?

:TRACe [:DATA]? <trace type>

Title: Trace Data Transfer

Description: This command transfers trace data from the instrument to the controller. The <trace type> must be one of the following:
SPECTrum | EMISsion | DEMod | PSCAn | MPATh | ACPR.

The format of the block data in the query form is specified by :FORMat:DATA. The block data in the command form is always sent in ASCII format.

The response begins with an ASCII header that specifies the number of data bytes. It looks like #AX, where A is the number of digits in X and X is the number of bytes that follow the header. Each data point is separated by a comma delimiter.

Trace setup information can be acquired using :TRACe[:DATA]:PREamble?. Use the commands in the MMEMory subsystem to store and recall traces from the instrument memory.

The RF measurements ACPR and Channel Spectrum both only have one value per data point that is returned in dBm. Each value is 4 bytes.

For the RF Spurious Emission measurement, each data point will have two values. The first value is the wave data, while the second value is the mask data. Both values are four bytes and returned in dBm.

The Demodulator Code Domain Power measurement has four values per data point. The first value is the point number, which has no unit. The second value is the relative power returned in dB. The third value is the absolute power returned in dBm. The fourth value is the type, which is defined in the following table.

Return Value	Signal Type	Color
0	Noise	Grey
1	IS95 Traffic	Yellow
2	CDMA2000 Traffic	Orange
3	CDMA2000 Traffic	Orange
4	Pilot	Red
5	Sync	Blue
6	Page	Green
7	Q Page	Purple

All values are four bytes each.

Both of the Over the Air (OTA) measurements, Pilot Scan and Multipath, will have three values per data point. The first value is the type, which can be 0 (Noise, Grey), 1 (Primary, Blue), and 2 (Secondary, Red), or. The second value is the Ec/Io returned in dB. The third value is Tau returned in s. All three values are the same and are 4 bytes each.

Note that the instrument must be set in the selected view. Use the CONFIGure command to set the unit to the selected view.

Parameter: <trace type>

Related Command: :FORMat [:DATA]
:TRACe [:DATA] :PREamble?

9-12 :TRIGger Subsystem

This subsystem contains commands related to the triggering of instrument functions for the purposes of synchronization. Related commands appear in the ABORT and INITiate subsystems.

:TRIGger:SEQuence:SLOPe RISing|FALLing

:TRIGger:SEQuence:SLOPe?

Title: External Trigger Polarity

Description: This command sets the external trigger polarity. Note that this setting can only be changed when the PN Type is set to "EXT".

Parameter: RISing | FALLing

Parameter Type: <char>

Default Value: RISing

Default Unit: NA

Range: RISing, FALLing

Related Command: [:SENSe]:PN:TRIGger
[:SENSe]:PN:TRIGger?

Front Panel

Access: Setup, Ext Trig Polarity

9-13 :UNIT Subsystem

The unit subsystem is used to modify the default units used for related parameters. These changes affect parameters in both commands and responses.

:UNIT:POWer DBM|W

:UNIT:POWer?

Description: Sets the default amplitude units for input, output and display.

Parameter: DBM|W

Parameter Type: <char>

Default Value: dBm

Front Panel

Access: Amplitude, Unit

9-14 [[:SENSE] Subsystem

The commands in this subsystem relate to device-specific parameters, not signal-oriented parameters.

[[:SENSE]:ACPower:BANDwidth:MAIN <freq>

[[:SENSE]:ACPower:BANDwidth:MAIN?

Title: ACPR Main Channel Bandwidth

Description: Sets the main channel carrier bandwidth. The <freq> value must be 1.23 | 1.24 | 1.25.

Parameter: <freq>

Default Value: 1.25 MHz

Default Unit: MHz

Range: 1.23 MHz, 1.24 MHz, 1.25 MHz

Front Panel

Access: Setup, Carrier BW (MHz)

[[:SENSE]:DEMod:CDPower:UNITs RELative|ABSolute

[[:SENSE]:DEMod:CDPower:UNITs?

Title: Code Domain Power Unit Type

Description: Sets the Code Domain Power unit type. The query form returns either a "REL" for relative units, or an "ABS" for absolute units in Ascii (without the double quotes).

Parameter: RELative | ABSolute

Parameter Type: <char>

Default Value: RELative

Range: RELative, ABSolute

Front Panel

Access: Measurements, Demodulator, CDP, CDP Units

[:SENSE]:DEMod:CDPower:ZOOM 16|32|64

[:SENSE]:DEMod:CDPower:ZOOM?

Title: Code Domain Power Zoom

Description: Sets the zoom for the Code Domain Power measurement. The query form returns either 16, 32, or 64.

Parameter: 16|32|64

Default Value: 16

Range: 16, 32, 64

Related Command: [:SENSE]:DEMod:CDPower:ZOOM:START
[:SENSE]:DEMod:CDPower:ZOOM:START?

Front Panel

Access: Measurements, Demodulator, CDP, Zoom

[:SENSE]:DEMod:CDPower:ZOOM:START <integer>

[:SENSE]:DEMod:CDPower:ZOOM:START?

Title: Code Domain Power Zoom Start Index

Description: Sets the zoom start index for the Code Domain Power measurement.

Parameter: <integer>

Parameter Type: <integer>

Default Value: 0

Range: 0 to 112

Related Command: [:SENSE]:DEMod:CDPower:ZOOM
[:SENSE]:DEMod:CDPower:ZOOM?

Front Panel

Access: Measurements, Demodulator, CDP, Zoom Start Index

[:SENSE]:FREQUENCY:CENTER <freq>

[:SENSE]:FREQUENCY:CENTER?

Title: Center Frequency

Description: Sets the center frequency. Note that changing the value of the center frequency will change the value of the coupled parameters Start Frequency and Stop Frequency. It may also change the value of the span.

Parameter: <freq>

Default Value: 1 GHz

Default Unit: Hz

Range: 1 MHz to 2.7 GHz

Front Panel

Access: Freq, Center Freq

[:SENSe]:FREQuency:SIGStandard:CHANnel <number>

[:SENSe]:FREQuency:SIGStandard:CHANnel?

Title: Channel Selection

Description: Sets the channel number for the selected signal standard.

Parameter: <number>

Front Panel

Access: Freq, Channel

[:SENSe]:FREQuency:SIGStandard:NAME <string>

[:SENSe]:FREQuency:SIGStandard:NAME?

Title: Signal Standard

Description: Selects the desired signal standard from the list. The <string> argument is the name of the desired signal standard as displayed in the instrument's current signal standard list. The list can be displayed on the instrument by choosing the Signal Standard submenu button in the Freq menu. The list can also be downloaded remotely and viewed using Anritsu Master Software Tools. For example, if the desired Signal Standard is P-GSM 900 - Uplink, then the value of the <string> argument would be "P-GSM 900 - Uplink".

The query form of this command will return the name of the currently selected Signal Standard on the list.

Parameter: <string>

Front Panel

Access: Freq, Signal Standard

[:SENSe]:FREQuency:SPAN?

Title: Frequency Span

Description: This is a query command only. The user can not set the span in CDMA or EVDO modes.

Parameter: <freq>

Default Unit: Hz

[:SENSE]:PFail <test set>

[:SENSE]:PFail?

Title: PASS/FAIL Test Selection

Description: Selects the active test set to be used in subsequent PASS/FAIL measurements. The <test set> value must correspond to a test set that is defined in the test set list. To view the list on the instrument, go into the "Measurement" menu, press the "Pass/Fail Mode" key, and then press the "Select Pass/Fail Test" submenu. Alternatively, the list can be retrieved remotely and viewed using the Anritsu Master Software Tools. The <test set> argument is a 1-based index of the position of the desired Pass/Fail test set in the instrument's current Pass/Fail test set list. For example, if the desired Pass/Fail test is the 3rd item on the list, then the value of the <test set> argument would be 3.

When using the query form of the command, the return value is the currently selected test set number. If there is not a valid test set selected, the return value is "-1" (negative 1).

Parameter: <test set>

Related Command: :CONFigure PFail

Front Panel

Access: Measurements, Pass/Fail Mode, Select Pass/Fail Test

[:SENSE]:PN:OFFSet <integer>

[:SENSE]:PN:OFFSet?

Title: PN Offset

Description: Sets the PN offset. Note that this can only be changed when PN Trigger is set to "GPS", or "EXT". A return value of the PN offset query is invalid when PN search type is AUTO.

Parameter: <integer>

Parameter Type: <integer>

Default Value: 0

Range: 0 to 511

Related Command: [:SENSE]:PN:TRIGger
[:SENSE]:PN:TRIGger?
[:SENSE]:PN:STYPe [:SENSE]:PN:STYPe?

Front Panel

Access: Setup, PN Setup, Manual PN Offset

[:SENSe] :PN:STYPe:AUTO 1|0|ON|OFF

[:SENSe] :PN:STYPe:AUTO?

Title: PN Search Type

Description: Sets the PN search type. The default value is ON. That is, sending :SENSe:PN:STYPe:AUTO is equivalent to sending :SENSe:PN:STYPe:AUTO ON. The query form returns either a 1 for ON, or a 0 for OFF. Note that this can only be changed when PN Trigger is set to "GPS", or "EXT".

Parameter: 1|0|ON|OFF

Parameter Type: <boolean>

Default Value: ON

Range: ON, OFF

Related Command: [:SENSe] :PN:TRIGger
[:SENSe] :PN:TRIGger?
[:SENSe] :PN:OFFSet [:SENSe] :PN:OFFSet?

Front Panel

Access: Setup, PN Setup, PN Trigger (GPS|Ext), PN Search Type

[:SENSe] :PN:TRIGger NOTRig|GPS|EXT

[:SENSe] :PN:TRIGger?

Title: External PN Trigger

Description: Sets the external PN trigger. The query form returns either "NOTRIG", "GPS", or "EXT" in Ascii (without the double quotes).

Parameter: NOTRig|GPS|EXT

Parameter Type: <char>

Default Value: No Trig

Range: NOTRig, GPS, EXT

Related Command: [:SENSe] :PN:STYPe
[:SENSe] :PN:STYPe?
[:SENSe] :PN:OFFSet [:SENSe] :PN:OFFSet?

Front Panel

Access: Setup, PN Setup, PN Trigger

[:SENSe]:POWer[:RF]:RANGe:AUTO OFF|ON|0|1

[:SENSe]:POWer[:RF]:RANGe:AUTO?

Title: Automatic Amplitude Range

Description: Sets the automatic amplitude range. Setting the value to ON or 1 will result in the amplitude range being coupled to the detected input signal level. Setting the value to OFF or 0 will result in the input attenuation being un-coupled from the input signal level. That is, changing the input signal level will not change the amplitude range. When this command is issued, the amplitude range itself will not change. The default value is ON. That is, sending :SENS:POW:RANG:AUTO is equivalent to sending :SENS:POW:RANG:AUTO ON.

Parameter: OFF|ON|0|1

Parameter Type: <boolean>

Default Value: ON

Related Command: [:SENSe]:POWer[:RF]:RANGe

Front Panel

Access: Amplitude, Auto Range

[:SENSe]:POWer[:RF]:RANGe[:IMMediate]

Title: Amplitude Range

Description: Re-calculates amplitude range. Note that issuing this command will set the automatic dynamic range OFF.

Related Command: [:SENSe]:POWer[:RF]:RANGe:AUTO

Front Panel

Access: Amplitude, Adjust Range

[:SENSe]:RF:ACPR:MAINchannelcount <integer>

[:SENSe]:RF:ACPR:MAINchannelcount?

Title: Main Channel Carrier Count

Description: Sets the number of main channel carriers.

Parameter: <integer>

Parameter Type: <integer>

Default Value: 1

Range: 1 to 5

Front Panel

Access: Setup, Number of Carriers

[:SENSE] :SWEep :SPEEd FAST|NORM|SLOW

[:SENSE] :SWEep :SPEEd?

Title: Measurement Speed

Description: Sets the measurement speed. The query form returns either "FAST", "NORM", or "SLOW" in Ascii (without the double quotes).

Parameter: FAST|NORM|SLOW

Parameter Type: <char>

Default Value: Norm

Range: FAST, NORM, SLOW

Front Panel

Access: Setup, Meas Speed

[:SENSE] :WCODe 64|128

[:SENSE] :WCODe?

Title: Walsh Codes

Description: Sets the Walsh codes.

Parameter: 64|128

Default Value: 128

Range: 64, 128

Front Panel

Access: Setup, Walsh Codes

Chapter 10 — EVDO Commands

10-1 :ABORt Subsystem

The abort subsystem includes commands that allow the user to stop current measurement activities on the instrument.

:ABORt

Title: Abort

Description: Restarts the current sweep and/or measurement. Resets the trigger system. If :INITiate:CONTinuous is OFF (i.e. the instrument is in single sweep mode), send the command :INITiate[:IMMediate] to trigger the next sweep. If :INITiate:CONTinuous is ON (i.e. the instrument is in continuous sweep mode), a new sweep will start immediately.

Parameter: NA

Related Command: :INITiate:CONTinuous
:INITiate[:IMMediate]

10-2 :CALCulate Subsystem

The commands in this subsystem process data that has been collected via the CALCulate subsystem. Valid measurements with the use of markers are RF Measurement - Channel Spectrum and the Demodulator Measurement - CDP MAC.

:CALCulate:MARKer:AOff

Title: Turn All Markers Off

Description: Turns off all markers.

Front Panel

Access: Marker, All Markers Off

:CALCulate:MARKer{1|2|3|4|5|6}:Y?

Title: Marker Read Y Value

Description: Reads the current Y value for the specified marker. The units are the units of the y-axis.

Default Unit: Current y-axis unit

:CALCulate:MARKer{1|2|3|4|5|6}[:STATe] OFF|ON|0|1

:CALCulate:MARKer{1|2|3|4|5|6}[:STATe]?

Title: Marker State

Description: Sets the specified marker on/off.

Parameter: OFF|ON|0|1

Parameter Type: <boolean>

Default Value: OFF

Example: To turn off reference marker #1:

```
:CALCulate:MARKer1:STATe OFF
```

Front Panel

Access: Marker, On/Off

10-3 :CONFigure Subsystem

This set of commands prepares the instrument for the selected measurement. It disables any currently-enabled measurements and activates the specified measurement. It sets it to SS and triggers ONE sweep. It will not initiate the taking of a measurement.

Current instrument settings may be changed to default values. These changes are identified with their respective measurement commands.

:CONFigure SUMMary|PFail

Title: Configure Summary and Pass/Fail Measurements

Description: This command configures the summary and PASS/FAIL measurements. It disables any other active measurements. None of the instrument parameters are changed by the execution of this command. Sets the instrument to single sweep mode (:INITiate:CONTinuous OFF). Measurement settings can be modified by using the [:SENSE] commands before initiating a measurement.

Parameter: SUMMary|PFail

Parameter Type: <char>

Front Panel

Access: Measurements

:CONFigure:DEMod <char>

Title: Configure Demodulation Measurement

Required Option: 63

Description: Valid <char> parameter options: SUMMary|CDPMac|CDPData

This command configures the selected demodulation measurement. It disables any other active measurements. Sets the instrument to single sweep mode (:INITiate:CONTinuous OFF). Measurement settings can be modified by using the [:SENSE]:DEMod commands before initiating a measurement.

When the SUMMARY option is selected, the measurement results are equivalent to the results that are displayed by choosing Measurements, then Demodulator, then Modulation Summary from the front panel. When the CDPMac option is selected, the measurement results are equivalent to the results that are displayed by choosing Measurements, then Demodulator, then CDP MAC from the front panel. When the CDPData option is selected, the measurement results are equivalent to the results that are displayed by choosing Measurements, then Demodulator, then CDP Data from the front panel.

Parameter: <char>

Front Panel

Access: Measurements, Demodulator

:CONFigure:OTA <char>

Title: Configure Over-The-Air Measurement

Required Option: 34

Description: This command configures the selected Over The Air measurement. It disables any other active measurements. Sets the instrument to single sweep mode (:INITiate:CONTInuous OFF). Measurement settings can be modified before initiating a measurement. When the PSCAn option is selected, the measurement results are equivalent to the results that are displayed by choosing Measurements, then OTA, then Pilot Scan from the front panel. When the MPATh option is selected, the measurement results are equivalent to the results that are displayed by choosing Measurements, then OTA, then Multipath from the front panel.

Parameter: <char> PSCAn, MPATh

:CONFigure:RF <char>

Title: Configure RF Measurement

Required Option: 62

Description: Valid parameter options:
SUMMArY | SPECTrum | ACPR | EMISsion | PVTime

This command configures the selected RF measurement. It disables any other active measurements. Sets the instrument to single sweep mode (:INITiate:CONTInuous OFF). Measurement settings can be modified by using the [:SENSE]:RF commands before initiating a measurement.

When the SUMMArY option is selected, the measurement results are equivalent to the results that are displayed by choosing Measurements, then RF, then RF Summary from the front panel. When the SPECTrum option is selected, the measurement results are equivalent to the results that are displayed by choosing Measurements, then RF, then Channel Spectrum from the front panel. When the ACPR option is selected, the measurement results are equivalent to the results that are displayed by choosing Measurements, then RF, then ACPR from the front panel.

When the EMISsion option is selected, the measurement results are equivalent to the results that are displayed by choosing Measurements, then RF, then Spurious Emission from the front panel. When the PVTime option is selected, the measurement results are equivalent to the results that are displayed by choosing Measurements, then RF, then Power vs. Time from the front panel.

Parameter: <char>

Related Command: [:SENSE]:FREQUency

10-4 :DISPlay Subsystem

This subsystem provides commands that modify the display of data for the user. They do not modify the way in which data are returned to the controller.

:DISPlay:WINDow:TRACe:Y[:SCALE]:OFFSet <rel ampl>

:DISPlay:WINDow:TRACe:Y[:SCALE]:OFFSet?

Title: Power Offset

Description: Sets the power offset value for the y-axis.

Parameter: <rel ampl>

Default Value: 0 dB

Default Unit: dB

Range: -100 dB to 100 dB

Front Panel

Access: Amplitude, Power Offset

:DISPlay:WINDow:TRACe:Y[:SCALE]:PDIVision <rel ampl>

:DISPlay:WINDow:TRACe:Y[:SCALE]:PDIVision?

Title: Scale

Description: Sets the scale (dB/division) for the y-axis.

Parameter: <rel ampl>

Default Value: 10 dB/div

Default Unit: dB

Range: 1 dB to 15 dB

Front Panel

Access: Amplitude, Scale/div

10-5 :FETCh Subsystem

This set of commands returns the most recent measurement data of the active measurement. They will not switch to another measurement.

To make a new measurement, use the INITiate command. To get new measurement data, use the READ or MEASure query commands.

:FETCh:DEMod:CDPData?

Title: Fetch Demodulator Code Domain Power Data

Required Option: 63

Description: Returns the most recent Code Domain Power Data measurement results.

Data is returned as 6 comma-delimited values: Active Data Power in the current user set unit (dBm/W/mW), Data Modulation, Rho Pilot, Rho Overall1, Max Data CDP in dB, and Min Data CDP in dB. All invalid values are replaced with "--".

Related Command: :CONFigure:DEMod CDPData
:MEASure:DEMod:CDPData?
:READ:DEMod:CDPData?

Front Panel

Access: Measurements, Demodulator, CDP Data

:FETCh:DEMod:CDPMac?

Title: Fetch Demodulator Code Domain Power MAC

Required Option: 63

Description: Returns the most recent Code Domain Power MAC measurement results.

Data is returned as 8 comma-delimited values: Pilot & MAC Power in the current user set unit (dBm/W/mW), Channel Power in the current user set unit (dBm/W/mW), Frequency Error in Hz, Frequency Error PPM, Rho Pilot, Rho Overall1, Data Modulation, and Noise Floor in dB. All invalid values are replaced with "--".

Related Command: :CONFigure:DEMod CDPMac
:MEASure:DEMod:CDPMac?
:READ:DEMod:CDPMac?

Front Panel

Access: Measurements, Demodulator, CDP MAC

:FETCh:DEMod:SUMMary?

Title: Fetch Demodulator Summary

Required Option: 63

Description: Returns the most recent Modulation Summary measurement results.

Data is returned as 12 comma-delimited values: Pilot & MAC Power in the current user set unit (dBm/W/mW), Channel Power in the current user set unit (dBm/W/mW), Rho Pilot, Rho Mac, Rho Data, Rho Overall1, Rho Overall2, Data Modulation, Noise Floor in dB, RMS Phase Error, Frequency Error in Hz, Tau in tens of microseconds. All invalid values are replaced with "--".

Related Command: :CONFigure:DEMod SUMMArY
:MEASure:DEMod:SUMMArY?
:READ:DEMod:SUMMArY?

Front Panel

Access: Measurements, Demodulator, Modulation Summary

:FETCh:OTA:MPATH?

Title: Fetch OTA Multipath

Required Option: 34

Description: Returns the most recent Multipath measurement results.

Data is returned as 14 comma-delimited values: six Ec/Io Values in dB, six Tau values in ps, Channel Power in the current user set unit (dBm/W/mW), and Multipath Power in dB. All invalid values are replaced with "--".

Related Command: :CONFigure:OTA MPATH
:MEASure:OTA:MPATH?
:READ:OTA:MPATH?

Front Panel

Access: Measurements, OTA, Multipath

:FETCh:PFail?

Title: Fetch PASS/FAIL

Description: Returns the most recent PASS/FAIL measurement results.

Measurement results are returned in a block of ASCII text in the format of <header><block>. The ASCII header specifies the number of data bytes. It looks like #AX, where A is the number of digits in X and X is the number of bytes in the <block>. The block consists of a set of records which indicate individual test results. Records are comma-separated. Each record follows the format <test ID>: <input1> <input2> <min> <max> <value1> <value2> <PASS/FAIL/OPTION NOT INSTALLED>. The <test ID> field indicates which test was performed to retrieve these results. The <input1> and <input2> fields indicate the test setup. The

<min> and <max> fields indicate the minimum and maximum values against which <value1> and <value2> were compared to arrive at the final PASS/FAIL result. If the specified test is not available in the instrument, the <PASS/FAIL> field will indicate “option not available” instead of “pass” or “fail”. All unused fields for a given test are represented by a double dash (“--”). To receive valid measurements, the Pass/Fail measurement must be the active. The current measurement can be queried using CONFigure?. Use the :CONFigure PFail command to set Pass/Fail as the active measurement.

Related Command: MEASure:PFail?
:CONFigure PFail
READ:PFail?

:FETCh:RF:ACPR?

Title: Fetch Adjacent Channel Power Ratio

Required Option: 62

Description: Returns the most recent Adjacent Channel Power Ratio measurement results.

Data is returned as 9 comma-delimited values: The Absolute Adjacent Channel 1 Power, Absolute Adjacent Channel 2 Power, Absolute Main Channel 1 Power, Absolute Main Channel 2 Power, Absolute Main Channel 3 Power, Absolute Main Channel 4 Power, Absolute Main Channel 5 Power, Absolute Adjacent Channel 3 Power, Absolute Adjacent Channel 4 Power. All values are returned in dBm. Note that the values for all five main channel carriers are shown even if the number of carriers set on the instrument is below five.

Related Command: :CONFigure:RF ACPR
:MEASure:RF:ACPR?
:READ:RF:ACPR?

Front Panel

Access: Measurements, RF Measurements, ACPR

:FETCh:RF:EMISSion?

Title: Fetch RF Spurious Emission

Required Option: CDMA: 42
EVDO, TDSCDMA: 62

Description: Returns the most recent Spurious Emission measurement result.

Data is returned as 5 comma-delimited values for each marker/boundary (40 values total): Marker Amplitude in dB, Marker Frequency in Hz, RBW in Hz, Pass/Fail, and Mask Boundary Frequency in Hz. Markers that are not on will return “--” for Marker Amplitude, Marker Frequency, RBW, and Pass/Fail. All Mask Boundary Frequencies will show normally.

Related Command: :CONFigure:RF EMISsion
:MEASure:RF:EMISsion?
:READ:RF:EMISsion?

Front Panel

Access: Measurements, RF Measurements, Spurious Emission

:FETCh:RF:SPECTrum?

Title: Fetch RF Spectrum

Required Option: 62

Description: Returns the most recent RF Channel Spectrum measurement results.

Data is returned as 4 comma-delimited values: Channel Power in the current user set unit (dBm/W/mW), Occupied bandwidth in Hz, Channel Power in fW, and Peak to Average Power in dB.

Related Command: :CONFigure:RF SPECTrum
:MEASure:RF:SPECTrum?
:READ:RF:SPECTrum?

Front Panel

Access: Measurements, RF Measurements, Channel Spectrum

10-6 :FORMat Subsystem

This subsystem contains commands that determine the formatting of numeric data when it is transferred.

The format setting affects data in specific commands only. If a command is affected, it is noted in the command description.

:FORMat[:READings][:DATA] ASCii|INTeger,32|REAL,32

:FORMat[:READings][:DATA]?

Title: Numeric Data Format

Description: This command specifies the format in which data is returned in certain commands.

ASCii format returns the data in comma-separated ASCII format. The units are the current instrument units. This format requires many more bytes so it is the slowest format. INTeger 32 values are signed 32-bit integers in little-endian byte order. This format returns the data in 4-byte blocks. REAL,32 values are 32-bit floating point numbers conforming to the IEEE 754 standard in little-endian byte order. This format returns the data in 4-byte binary format. The units are the current instrument units.

Both INTeger,32 and REAL,32 formats return a definite block length. Each transfer begins with an ASCII header such as #42204. The first digit represents the number of following digits in the header (in this example, 4). The remainder of the header indicates the number of bytes that follow the header (in this example, 2204). You then divide the number of following bytes by the number of bytes in the data format you've chosen (4 for both INTeger,32 and REAL,32) to get the number of data points (in this example, 551).

Parameter: ASCii|INTeger,32|REAL,32

Parameter Type: <char>

Default Value: ASCii

Related Command: :TRACe[:DATA]

10-7 :INITiate Subsystem

This subsystem controls the triggering of measurements.

:INITiate:CONTinuous OFF|ON|0|1

:INITiate:CONTinuous?

Title: Continuous/Single Sweep

Description: Specifies whether the sweep/measurement is triggered continuously. If the value is set to ON or 1, another sweep/measurement is triggered as soon as the current one completes. If continuous is set to OFF or 0, the instrument enters the “idle” state and waits for the :INITiate[:IMMEDIATE] command or for :INITiate:CONTinuous ON. The default value is ON. That is, sending :INIT:CONT is equivalent to sending :INIT:CONT ON. The query version of the command returns a 1 if the instrument is continuously sweeping/measuring and returns a 0 if the instrument is in single sweep/measurement mode. Note that rapid toggling between ON and OFF is not allowed. The instrument must be allowed to make a full sweep before toggling can be done.

Note: Issue the command :INITiate[:IMMEDIATE] after changing from single sweep mode to continuous sweep mode in order to begin sweeping.

Parameter: OFF|ON|0|1

Parameter Type: <boolean>

Default Value: ON

Related Command: :INITiate[:IMMEDIATE]

Front Panel

Access: Shift-3 (Sweep), Sweep

:INITiate[:IMMEDIATE]

Title: Trigger Sweep/Measurement

Description: Use this command in combination with :STATus:OPERation? to synchronize the capture of one complete set of data. When this command is sent, the “sweep complete” bit of :STATus:OPERation? is set to 0, indicating that the measurement has not completed. The data collection is then triggered. The controlling program can poll :STATus:OPERation? to determine the status. When the “sweep complete” bit is set to 1, data is ready to be retrieved.

Related Command: :INITiate:CONTinuous
:STATus:OPERation?

Front Panel

Access: Shift-3 (Sweep), Trigger Sweep

10-8 :MEASure Subsystem

These commands take the instrument from its current state, enable the specified measurement and put the instrument into single sweep mode. They correct any parameters that are invalid given the new measurement state such that a valid measurement can take place. Other settings may be changed; see the documentation of CONFigure for each measurement. They then initiate the measurement. When the measurement is complete, they return the result.

To make a measurement with settings other than the “default” measurement settings applied by CONFigure, do the following:

- Send the appropriate CONFigure command to set the desired measurement.
- Modify the settings as required.
- Send the appropriate READ command to measure and return the result.

To get the current measurement data, use the appropriate FETCh command.

:MEASure:DEMod:CDPData?

Title: Measure Demodulator Code Domain Power Data

Required Option: 63

Description: Sets the active measurement to Code Domain Power Data, sets the default measurement parameters, triggers a new measurement and returns the Active Data Power, Data Modulation, Rho Pilot, Rho Overall1, Max Data CDP, and Min Data CDP. It is a combination of the commands :CONFigure:DEMod CDPData and :READ:DEMod:CDPData? To make a CDP Data measurement with settings other than the default values, send:

```
:CONFigure:DEMod CDPData
Commands to set desired settings
:READ:DEMod:CDPData?
```

Data is returned as 6 comma-delimited values: Active Data Power in the current user set unit (dBm/W/mW), Data Modulation, Rho Pilot, Rho Overall1, Max Data CDP in dB, and Min Data CDP in dB. All invalid values are replaced with “--”.

Related Command: :CONFigure:DEMod CDPData
:READ:DEMod:CDPData?
:FETCh:DEMod:CDPData?

Front Panel

Access: Measurements, Demodulator, CDP Data

:MEASure:DEMod:CDPMac?

Title: Measure Demodulator Code Domain Power MAC

Required Option: 63

Description: Sets the active measurement to Code Domain Power Mac, sets the default measurement parameters, triggers a new measurement and returns the Pilot & MAC Power, Channel Power, Frequency Error, Frequency Error PPM, Rho Pilot, Rho Overall1, Data Modulation, Noise Floor. It is a combination of the commands :CONFigure:DEMod CDPMac and :READ:DEMod:CDPMac? To make a CDP MAC measurement with settings other than the default values, send:

:CONFigure:DEMod CDPMac

Commands to set desired settings

:READ:DEMod:CDPMac?

Data is returned as 8 comma-delimited values: Pilot & MAC Power in the current user set unit (dBm/W/mW), Channel Power in the current user set unit (dBm/W/mW), Frequency Error in Hz, Frequency Error PPM, Rho Pilot, Rho Overall1, Data Modulation, and Noise Floor in dB. All invalid values are replaced with "--".

Related Command: :CONFigure:DEMod CDPMac
:READ:DEMod:CDPMac?
:FETCh:DEMod:CDPMac?

Front Panel

Access: Measurements, Demodulator, CDP MAC

:MEASure:DEMod:SUMMARY?

Title: Measure Demodulator Summary

Required Option: 63

Description: Sets the active measurement to Modulation Summary, sets the default measurement parameters, triggers a new measurement and returns the Pilot & MAC Power, Channel Power, Rho Pilot, Rho Mac, Rho Data, Rho Overall1, Rho Overall2, Data Modulation, Noise Floor, RMS Phase Error, Frequency Error and Tau. It is a combination of the commands :CONFigure:DEMod SUMMARY and :READ:DEMod:SUMMARY? To make a Demodulator Summary measurement with settings other than the default values, send:

:CONFigure:DEMod SUMMARY

Commands to set desired settings

:READ:DEMod:SUMMARY?

Data is returned as 12 comma-delimited values: Pilot & MAC Power in the current user set unit (dBm/W/mW), Channel Power in the current user set unit (dBm/W/mW), Rho Pilot, Rho Mac, Rho Data, Rho Overall1, Rho Overall2, Data Modulation, Noise Floor in dB, RMS Phase Error, Frequency Error in Hz, Tau in tens of microseconds. All invalid values are replaced with "--".

Related Command: :CONFigure:DEMod SUMMary
:READ:DEMod:SUMMary?
:FETCh:DEMod:SUMMary?

Front Panel

Access: Measurements, Demodulator, Modulation Summary

:MEASure:OTA:MPATH?

Title: Measure OTA Multipath

Required Option: 34

Description: Sets the active measurement to Multipath, sets the default measurement parameters, triggers a new measurement and returns six Ec/Io values, six Tau values, Channel Power, and Multipath Power. It is a combination of the commands :CONFigure:OTA MPATH and :READ:OTA:MPATH?. To make an OTA Multipath measurement with settings other than the default values, send:

```
:CONFigure:OTA MPATH
Commands to set desired settings
:READ:OTA:MPATH?
```

Data is returned as 14 comma-delimited values: six Ec/Io Values in dB, six Tau values in ps, Channel Power in the current user set unit (dBm/W/mW), and Multipath Power in dB. All invalid values are replaced with "--".

Related Command: :CONFigure:OTA MPATH
:READ:OTA:MPATH?
:FETCh:OTA:MPATH?

Front Panel

Access: Measurements, OTA, Multipath

:MEASure:PFail?

Title: Measure PASS/FAIL

Description: Sets the active measurement to PASS/FAIL, sets the default measurement parameters, triggers a new measurement and returns the PASS/FAIL results. It is a combination of the commands :CONFigure PFail and :READ:PFail?. To make a PASS/FAIL measurement with settings other than the default values, send:

:CONFigure PFail
 Commands to set desired settings
 :READ:PFail?

Related Command: :CONFigure PFail
 READ:PFail?
 FETCh:PFail?

Front Panel

Access: Measurements, Pass/Fail mode

:MEASure:RF:ACPR?

Title: Measure Adjacent Channel Power Ratio

Required Option: 62

Description: Sets the active measurement to ACPR, sets the default measurement parameters, triggers a new measurement, and returns the power levels for each of the adjacent and main channels (9 total). It is a combination of the commands :CONFigure:RF ACPR and :READ:RF:ACPR? To make an RF ACPR measurement with settings other than the default values, send:

:CONFigure:RF ACPR
 Commands to set desired settings
 :READ:RF:ACPR?

Data is returned as 9 comma-delimited values: The Absolute Adjacent Channel 1 Power, Absolute Adjacent Channel 2 Power, Absolute Main Channel 1 Power, Absolute Main Channel 2 Power, Absolute Main Channel 3 Power, Absolute Main Channel 4 Power, Absolute Main Channel 5 Power, Absolute Adjacent Channel 3 Power, Absolute Adjacent Channel 4 Power. All values are returned in dBm.

Note that the values for all five main channel carriers are shown even if the number of carriers set on the instrument is below five.

Related Command: :READ:RF:ACPR?
 :CONFigure:RF ACPR
 :FETCh:RF:ACPR?

Front Panel

Access: Measurements, RF Measurements, ACPR

:MEASure:RF:EMISsion?

Title: Measure RF Spurious Emission

Required Option: 62

Description: Sets the active measurement to Spurious Emission, sets the default measurement parameters, triggers a new measurement and returns the Marker Amplitude, Marker Frequency, RBW, a Pass/Fail assessment, and the Mask Boundary Frequency for all markers/boundaries. It is a combination of the commands :CONFigure:RF EMISsion and :READ:RF:EMISsion? To make an RF Spurious Emission measurement with settings other than the default values, send:

```
:CONFigure:RF EMISsion
Commands to set desired settings
:READ:RF:EMISsion?
```

Data is returned as 5 comma-delimited values for each marker/boundary: Marker Amplitude in dB, Marker Frequency in Hz, RBW in Hz, Pass/Fail, and Mask Boundary Frequency in Hz.

Markers that are not on will return "--" for Marker Amplitude, Marker Frequency, RBW, and Pass/Fail. Mask Boundary Frequency will show normally despite the corresponding marker being off.

Related Command: :CONFigure:RF EMISsion
:READ:RF:EMISsion?
:FETCh:RF:EMISsion?

Front Panel

Access: Measurements, RF Measurements, Spurious Emission

:MEASure:RF:SPECTrum?

Title: Measure RF Spectrum

Required Option: 62

Description: Sets the active measurement to Channel Spectrum, sets the default measurement parameters, triggers a new measurement and returns the Channel Power (Current User Set Unit), Occupied Bandwidth, Channel Power (Watts) and Peak to Average Power measurement results. It is a combination of the commands :CONFigure:RF SPECTrum and :READ:RF:SPECTrum? To make an RF Spectrum measurement with settings other than the default values, send:

```
:CONFigure:RF SPECTrum
Commands to set desired settings
:READ:RF:SPECTrum?
```

Data is returned as 4 comma-delimited values: Channel Power in the current user set unit (dBm/W/mW), Occupied bandwidth in Hz, Channel Power in fW, and Peak to Average Power in dB.

Related Command: :CONFigure:RF SPECTrum
:READ:RF:SPECTrum?
:FETCh:RF:SPECTrum?

Front Panel

Access: Measurements, RF Measurements, Channel Spectrum

10-9 :MMEMory Subsystem

The Mass Memory subsystem contains functions that provide access to the instrument's setup and data storage.

:MMEMory:DELeTe <filename>

Title: Delete Setup/Measurement

Description: Removes a file specified by <filename> from the current mass storage device. <filename> should be enclosed in either single quotes (') or double quotes (" ") and it must include the file extension. Use the command MMEMory:MSIS to set the current file location.

Parameter: <filename>

Related Command: :MMEMory:STORe:STATe
:MMEMory:STORe:TRACe
:MMEMory:MSIS INTernal|USB

Front Panel

Access: Shift-7 (File), Delete, Delete Selected File

:MMEMory:LOAD:STATe <integer>,<filename>

Title: Recall Setup

Description: Recalls a previously stored instrument setup in the current save location. The setup file to be loaded is specified by <filename>. <filename> should be enclosed in either single quotes (') or double quotes (" ") and should contain a file extension ".stp". Use the command MMEMory:MSIS to set the current save location. The <integer> parameter is not currently used, but it must be sent. Send a 1.

Parameter: <integer>, <filename>

Related Command: :MMEMory:STORe:STATe
:MMEMory:MSIS INTernal|USB

Front Panel

Access: Shift-7 (File), Recall

:MMEMory:LOAD:TRACe <integer>,<filename>

Title: Recall Measurement

Description: The instrument must be in the mode of the saved trace in order to recall that trace. Use :INSTRument:SELeCt or :INSTRument:NSELeCt to set the mode. Recalls a previously stored measurement trace from the current save location. The saved measurement trace to be loaded is specified by <filename>. <filename> should be enclosed in either single quotes (') or double quotes (" ") and should contain a file extension. Note that the trace specified by <filename> should be available at the current save location. Use the command MMEMory:MSIS to set the current save location. The <integer> parameter is not currently used, but it must be sent. Send a 1.

File name extensions:

“.edg” for GSM
 “.spa” for SPA
 “.wcd” for WCDMA
 “.wmxd” for WiMAX
 “.wmxe” for Mobile WiMAX
 “.vna” for Cable & Antenna
 “.cdma” for CDMA
 “.tds” for TDSCDMA
 “.evdo” for EVDO
 “.ia” for Interference Analysis
 “.cs” for Channel Scanner
 “.pm” for Power Meter
 “.tm” for Transmission Measurement
 “.lte” for LTE Analyzer

Note: Extensions not available for T1 and Hi_PM.

Parameter: <integer>, <filename>

Example: To recall trace with file name “trace”:

```
:MMEMory:LOAD:TRACe 1, "trace.spa"
```

Related Command: :MMEMory:STORe:TRACe
 :MMEMory:STORe:TRACe
 :MMEMory:MSIS INTernal|USB

Front Panel

Access: Shift-7 (File), Recall Measurement

:MMEMory:STORe:STATe <integer>, <filename>

Title: Save Setup

Description: Stores the current setup into the file specified by <filename>. <filename> should be enclosed in either single quotes (') or double quotes (") and should not contain a file extension. Use the command MMEMory:MSIS to set the current save location. The <integer> parameter is not currently used, but it must be sent. Send a value of 0.

Parameter: <integer>, <filename>

Related Command: :MMEMory:LOAD:STATe
 :MMEMory:MSIS INTernal|USB

Front Panel

Access: Shift-7 (File)

:MMEMory:STORe:TRACe <integer>,<filename>

Title: Save Measurement

Description: Stores the trace into the file specified by <filename>. <filename> should be enclosed in either single quotes (' ') or double quotes (" ") and should not contain a file extension. Use the command MMEMory:MSIS to set the current save location. The <integer> parameter is not currently used, but it must be sent. Send a 0. Note that existing files of the same name will not be overwritten.

Parameter: <integer>, <filename>

Example: To save the trace into the file name "trace":

```
:MMEMory:STORe:TRACe 0,"trace"
```

Related Command: :MMEMory:LOAD:TRACe
:MMEMory:MSIS INTernal|USB

Front Panel

Access: Shift-7 (File), Save

10-10 :READ Subsystem

This set of commands combines the ABORT, INITiate and FETCh commands. It aborts any current triggering sequence and sets the trigger state to idle. It then initiates a new active measurement (i.e. begins the collection of new data). When the measurement is complete, it returns the result. These commands will not switch to another measurement.

To get the current measurement data, use the FETCh command.

:READ:OTA:MPATH?

Title: Read OTA Multipath

Required Option: 34

Description: Triggers a new measurement and returns six Ec/Io values, six Tau values, Channel Power, and Multipath Power. It is a combination of the following commands :ABORT; :INITiate; :FETCh:OTA:MPATH? In order for the data to be accurate, the Multipath measurement must be the active measurement (specified by :CONFigure:OTA MPATH). The current measurement can be queried using :CONFigure?

Data is returned as 14 comma-delimited values: six Ec/Io Values in dB, six Tau values in ps, Channel Power in the current user set unit (dBm/W/mW), and Multipath Power in dB. All invalid values are replaced with "--".

Related Command: :CONFigure:OTA MPATH
:MEASure:OTA:MPATH?
:FETCh:OTA:MPATH?

Front Panel

Access: Measurements, OTA, Multipath

:READ:PFail?

Title: Read PASS/FAIL

Description: Triggers a new PASS/FAIL measurement and returns the results. It is a combination of the commands :ABORT; :INITiate; :FETCh:PFail? The PASS/FAIL measurement must be active. The current measurement can be queried using :CONFigure?

Related Command: :MEASure:PFail?
:CONFigure PFail
:FETCh:PFail?

Front Panel

Access: Measurements, Pass/Fail Mode

:READ:RF:ACPR?

Title: Read Adjacent Channel Power Ratio

Required Option: 62

Description: Triggers a new measurement, and returns the power levels for each of the adjacent and main channels (9 total). It is a combination of the commands :ABORT; :INITiate; :FETCh:RF:ACPR? In order for the data to be accurate, the ACPR measurement must be the active measurement (specified by :CONFigure:RF ACPR). The current measurement can be queried using :CONFigure?

Data is returned as 9 comma-delimited values: The Absolute Adjacent Channel 1 Power, Absolute Adjacent Channel 2 Power, Absolute Main Channel 1 Power, Absolute Main Channel 2 Power, Absolute Main Channel 3 Power, Absolute Main Channel 4 Power, Absolute Main Channel 5 Power, Absolute Adjacent Channel 3 Power, Absolute Adjacent Channel 4 Power. All values are returned in dBm. Note that the values for all five main channel carriers are shown even if the number of carriers set on the instrument is below five.

Related Command: :FETCh:RF:ACPR?
:CONFigure:RF ACPR
:MEASure:RF:ACPR?

Front Panel

Access: Measurements, RF Measurements, ACPR

:READ:RF:EMISsion?

Title: Read RF Spurious Emission

Required Option: 62

Description: Triggers a new measurement and returns the Marker Amplitude, Marker Frequency, RBW, a Pass/Fail assessment, and the Mask Boundary Frequency for all markers/boundaries. It is a combination of the following commands :ABORT; :INITiate; :FETCh:RF:EMISsion? In order for the data to be valid, the Spurious Emission measurement must be the active measurement (specified by :CONFigure:RF EMISsion). The current measurement can be queried using :CONFigure?

Data is returned as 5 comma-delimited values for each marker/boundary (40 values total): Marker Amplitude in dB, Marker Frequency in Hz, RBW in Hz, Pass/Fail, and Mask Boundary Frequency in Hz. Markers that are not on will return "--" for Marker Amplitude, Marker Frequency, RBW, and Pass/Fail. All Mask Boundary Frequencies will show normally.

Related Command: :CONFigure:RF EMISsion
:MEASure:RF:EMISsion?
:FETCh:RF:EMISsion?

Front Panel

Access: Measurements, RF Measurements, Spurious Emission

:READ:RF:SPECTrum?

Title: Read RF Spectrum

Required Option: 62

Description: Triggers a new measurement and returns the Channel Power (Current User Set Unit), Occupied Bandwidth, Channel Power (Watts) and Peak to Average Power measurement results. It is a combination of the following commands :ABORt; :INITiate; :FETCh:RF:SPECTrum? In order for the data to be accurate, the Channel Spectrum measurement must be the active measurement (specified by :CONFigure:RF SPECTrum). The current measurement can be queried using :CONFigure?

Data is returned as 4 comma-delimited values: Channel Power in the current user set unit (dBm/W/mW), Occupied bandwidth in Hz, Channel Power in fW, and Peak to Average Power in dB.

Related Command: :FETCh:RF:SPECTrum?
:CONFigure:RF SPECTrum
:MEASure:RF:SPECTrum?

Front Panel

Access: Measurements, RF Measurements, Channel Spectrum

10-11 :TRACe Subsystem

This subsystem contains commands related to the transfer of trace data to and from the instrument.

:TRACe:PREamble? <trace type>

Title: Trace Header Transfer

Description: Returns trace header information for the specified trace. The <trace type> must be one of the following:
SPECTrum | EMISSion | CDPMac | CDPData | PSCAn | MPATH.

Data can be transferred to and from the 6 available display trace types. Use the commands in the MMEMory subsystem to store and recall traces from the instrument memory. The response begins with an ASCII header. The header specifies the number of following bytes. It looks like #AX, where A is the number of digits in X and X is the number of bytes that follow the header.)

Parameters are returned in comma-delimited ASCII format. Each parameter is returned as "NAME=VALUE[UNITS]," Valid parameter names are shown in "[EVDO Parameter Names](#)" on page 2-29.

Parameter: <trace type>

Related Command: :TRACe:DATA?

:TRACe[:DATA]? <trace type>

Title: Trace Data Transfer

Description: This command transfers trace data from the instrument to the controller. The <trace type> must be one of the following:
SPEcTrum | EMISsion | CDPMac | CDPData | PSCAn | MPATh | ACPR.

The format of the block data in the query form is specified by :FORMat:DATA. The block data in the command form is always sent in ASCII format. The response begins with an ASCII header that specifies the number of data bytes. It looks like #AX, where A is the number of digits in X and X is the number of bytes that follow the header. Each data point is separated by a comma delimiter. Trace setup information can be acquired using :TRACe[:DATA]:PREamble?. Use the commands in the MMEMory subsystem to store and recall traces from the instrument memory.

The RF measurements ACPR and Channel Spectrum both only have one value per data point that is returned in dBm. Each value is 4 bytes.

For the RF Spurious Emission measurement, each data point will have two values. The first value is the wave data, while the second value is the mask data. Both values are four bytes and returned in dBm.

Power vs. Time data points have three values each. The first value is the wave data. The second value is the upper mask data. The third value is the lower mask data. All values are returned in dB and are 4 bytes each.

The Demodulator Code Domain Power MAC measurement has four values per data point. The first value is the point number, which has no unit. The second value is the relative power returned in dB. The third value is the absolute power returned in dBm. The fourth value is the type, which is defined in the following.

Return Value	Signal Type	Color
0	Noise	Grey
1	IS95 Traffic	Yellow
2	CDMA2000 Traffic	Orange
3	CDMA2000 Traffic	Orange
4	Pilot	Red
5	Sync	Blue
6	Page	Green
7	Q Page	Purple

For the Code Domain Power Data measurement, each data point has six values. The first value is the point number, which has no unit. The second value is the relative I Data Magnitude, which is returned in dB. The third value is the absolute I Data Magnitude returned in dBm. The fourth value is the relative Q Data Magnitude returned in dB. The fifth value is the absolute Q Data Magnitude returned in dBm. The sixth value is the type, which follows the table above in terms of returned values. All values are four bytes each.

Both of the Over the Air (OTA) measurements, Pilot Scan and Multipath, will have three values per data point. The first value is the type, which can be 0 (Noise, Grey), 1 (Primary, Blue), and 2 (Secondary, Red), or. The second value is the Ec/Io returned in dB. The third value is Tau returned in s. All three values are the same for both measurements and are 4 bytes each.

Note that the instrument must be set in the selected view. Use the CONFigure command to set the unit to the selected view.

Parameter: <trace type>

Related Command: :FORMat[:DATA]
:TRACe[:DATA]:PREamble?

10-12 :TRIGger Subsystem

This subsystem contains commands related to the triggering of instrument functions for the purposes of synchronization. Related commands appear in the ABORt and INITiate subsystems.

:TRIGger:SEQuence:SLOPe RISing|FALLing

:TRIGger:SEQuence:SLOPe?

Title: External Trigger Polarity

Description: This command sets the external trigger polarity. Note that this setting can only be changed when the PN Type is set to "EXT".

Parameter: RISing|FALLing

Parameter Type: <char>

Default Value: RISing

Default Unit: NA

Range: RISing, FALLing

Related Command: [:SENSe]:PN:TRIGger
[:SENSe]:PN:TRIGger?

Front Panel

Access: Setup, Ext Trig Polarity

10-13 :UNIT Subsystem

The unit subsystem is used to modify the default units used for related parameters. These changes affect parameters in both commands and responses.

:UNIT:POWER DBM|W

:UNIT:POWER?

Title: Measurement Units

Description: Sets the default amplitude units for input, output and display.

Parameter: DBM|W

Parameter Type: <char>

Default Value: dBm

Front Panel

Access: Amplitude, Unit

10-14 [:SENSE] Subsystem

The commands in this subsystem relate to device-specific parameters, not signal-oriented parameters.

[:SENSE] :ACPower :BANDwidth :MAIN <freq>

[:SENSE] :ACPower :BANDwidth :MAIN?

Title: ACPR Main Channel Bandwidth

Description: Sets the main channel carrier bandwidth. The <freq> value must be 1.23 | 1.24 | 1.25.

Parameter: <freq>

Default Value: 1.25 MHz

Default Unit: MHz

Range: 1.23 MHz, 1.24 MHz, 1.25 MHz

Front Panel

Access: Setup, Carrier BW (MHz)

[:SENSE] :DEMod :CDPower :UNITs RELative | ABSolute

[:SENSE] :DEMod :CDPower :UNITs?

Title: Code Domain Power Unit Type

Description: Sets the Code Domain Power unit type. The query form returns either a "REL" for relative units, or an "ABS" for absolute units in Ascii (without the double quotes).

Parameter: RELative | ABSolute

Parameter Type: <char>

Default Value: RELative

Range: RELative, ABSolute

Front Panel

Access: Measurements, Demodulator, CDP Data, CDP Units

[:SENSE]:DEMod:CDPower:ZOOM 16|32|64

[:SENSE]:DEMod:CDPower:ZOOM?

Title: Code Domain Power Zoom

Description: Sets the zoom for the Code Domain Power measurement. The query form returns either 16, 32, or 64.

Parameter: 16|32|64

Default Value: 16

Range: 16, 32, 64

Related Command: [:SENSE]:DEMod:CDPower:ZOOM:START
[:SENSE]:DEMod:CDPower:ZOOM:START?

Front Panel

Access: Measurements, Demodulator, CDP MAC, Zoom

[:SENSE]:DEMod:CDPower:ZOOM:START <integer>

[:SENSE]:DEMod:CDPower:ZOOM:START?

Title: Code Domain Power Zoom Start Index

Description: Sets the zoom start index for the Code Domain Power measurement.

Parameter: <integer>

Parameter Type: <integer>

Default Value: 0

Range: 0 to 112

Related Command: [:SENSE]:DEMod:CDPower:ZOOM
[:SENSE]:DEMod:CDPower:ZOOM?

Front Panel

Access: Measurements, Demodulator, CDP MAC, Zoom Start

[:SENSE]:FREQuency:CENTer <freq>

[:SENSE]:FREQuency:CENTer?

Title: Center Frequency

Description: Sets the center frequency.

Parameter: <freq>

Default Value: 1 GHz

Default Unit: Hz

Range: 1 MHz to 2.7 GHz

Front Panel

Access: Freq, Center Freq

[:SENSE]:FREQUENCY:SIGStandard:CHANNEL <number>

[:SENSE]:FREQUENCY:SIGStandard:CHANNEL?

Title: Channel Selection

Description: Sets the channel number for the selected signal standard.

Parameter: <number>

Front Panel

Access: Freq, Channel

[:SENSE]:FREQUENCY:SIGStandard:NAME <string>

[:SENSE]:FREQUENCY:SIGStandard:NAME?

Title: Signal Standard

Description: Selects the desired signal standard from the list. The <string> argument is the name of the desired signal standard as displayed in the instrument's current signal standard list. The list can be displayed on the instrument by choosing the Signal Standard submenu button in the Freq menu. The list can also be downloaded remotely and viewed using Anritsu Master Software Tools. For example, if the desired Signal Standard is P-GSM 900 - Uplink, then the value of the <string> argument would be "P-GSM 900 - Uplink".

The query form of this command will return the name of the currently selected Signal Standard on the list.

Parameter: <string>

Front Panel

Access: Freq, Signal Standard

[:SENSE]:FREQUENCY:SPAN?

Title: Frequency Span

Description: This is a query command only. The user can not set the span in CDMA or EVDO modes.

Parameter: <freq>

Default Unit: Hz

[:SENSE]:PFail <test set>

[:SENSE]:PFail?

Title: PASS/FAIL Test Selection

Description: Selects the active test set to be used in subsequent PASS/FAIL measurements. The <test set> value must correspond to a test set that is defined in the test set list. To view the list on the instrument, go into the "Measurement" menu, press the "Pass/Fail Mode" key, and then press the "Select Pass/Fail Test" submenu. Alternatively, the list can be retrieved remotely and viewed using the Anritsu Master Software Tools. The <test set> argument is a 1-based index of the position of the desired Pass/Fail test set in the instrument's current Pass/Fail test set list. For example, if the desired Pass/Fail test is the 3rd item on the list, then the value of the <test set> argument would be 3.

When using the query form of the command, the return value is the currently selected test set number. If there is not a valid test set selected, the return value is "-1" (negative 1).

Parameter: <test set>

Related Command: :CONFigure PFail

Front Panel

Access: Measurements, Pass/Fail Mode, Select Pass/Fail Test

[:SENSE]:PN:OFFSet <integer>

[:SENSE]:PN:OFFSet?

Title: PN Offset

Description: Sets the PN offset. Note that this can only be changed when PN Trigger is set to "GPS", or "EXT". A return value of the PN offset query is invalid when PN search type is AUTO.

Parameter: <integer>

Parameter Type: <integer>

Default Value: 0

Range: 0 to 511

Related Command: [:SENSE]:PN:TRIGger
[:SENSE]:PN:TRIGger?
[:SENSE]:PN:STYPe [:SENSE]:PN:STYPe?

Front Panel

Access: Setup, PN Setup, Manual PN Offset

[:SENSe]:PN:STYPe:AUTO 1|0|ON|OFF

[:SENSe]:PN:STYPe:AUTO?

Title: PN Search Type

Description: Sets the PN search type. The default value is ON. That is, sending :SENSe:PN:STYPe:AUTO is equivalent to sending :SENSe:PN:STYPe:AUTO ON. The query form returns either a 1 for ON, or a 0 for OFF. Note that this can only be changed when PN Trigger is set to "GPS", or "Ext".

Parameter: 1|0|ON|OFF

Parameter Type: <boolean>

Default Value: 1

Range: ON, OFF

Related Command: [:SENSe]:PN:TRIGger
[:SENSe]:PN:TRIGger?
[:SENSe]:PN:OFFSet [:SENSe]:PN:OFFSet?

Front Panel

Access: Setup, PN Setup (GPS|Ext), PN Search Type

[:SENSe]:PN:TRIGger NOTRIG|GPS|EXT

[:SENSe]:PN:TRIGger?

Title: External PN Trigger

Description: Sets the external PN trigger. The query form returns either "NOTRIG", "GPS", or "EXT" in Ascii (without the double quotes).

Parameter: NOTRIG|GPS|EXT

Parameter Type: <char>

Default Value: NOTRIG

Range: NOTRIG, GPS, EXT

Related Command: [:SENSe]:PN:STYPe
[:SENSe]:PN:STYPe?
[:SENSe]:PN:OFFSet [:SENSe]:PN:OFFSet?

Front Panel

Access: Setup, PN Setup, PN Trigger

[:SENSE]:POWER[:RF]:RANGE:AUTO OFF|ON|0|1

[:SENSE]:POWER[:RF]:RANGE:AUTO?

Title: Automatic Amplitude Range

Description: Sets the automatic amplitude range. Setting the value to ON or 1 will result in the amplitude range being coupled to the detected input signal level. Setting the value to OFF or 0 will result in the input attenuation being un-coupled from the input signal level. That is, changing the input signal level will not change the amplitude range. When this command is issued, the amplitude range itself will not change. The default value is ON. That is, sending :SENS:POW:RANG:AUTO is equivalent to sending :SENS:POW:RANG:AUTO ON.

Parameter: OFF|ON|0|1

Parameter Type: <boolean>

Default Value: ON

Related Command: [:SENSE]:POWER[:RF]:RANGE

Front Panel

Access: Amplitude, Auto Range

[:SENSE]:POWER[:RF]:RANGE[:IMMEDIATE]

Title: Amplitude Range

Description: Re-calculates amplitude range. Note that issuing this command will set the automatic dynamic range OFF.

Related Command: [:SENSE]:POWER[:RF]:RANGE:AUTO

Front Panel

Access: Amplitude, Adjust Range

[:SENSE]:RF:ACPR:MAINchannelcount <integer>

[:SENSE]:RF:ACPR:MAINchannelcount?

Title: Main Channel Carrier Count

Description: Sets the number of main channel carriers.

Parameter: <integer>

Parameter Type: <integer>

Default Value: 1

Range: 1 to 5

Front Panel

Access: Setup, Number of Carriers

[:SENSE]:SWEep:SPEed FAST|NORM|SLOW

[:SENSE]:SWEep:SPEed?

Title: Measurement Speed

Description: Sets the measurement speed. The query form returns either "FAST", "NORM", or "SLOW" in Ascii (without the double quotes).

Parameter: FAST|NORM|SLOW

Parameter Type: <char>

Default Value: Norm

Range: FAST, NORM, SLOW

Front Panel

Access: Setup, Meas Speed

[:SENSE]:WCODE 64|128

[:SENSE]:WCODE?

Title: Walsh Codes

Description: Sets the Walsh codes.

Parameter: 64|128

Default Value: 128

Range: 64, 128

Front Panel

Access: Setup, Walsh Codes

Chapter 11 — Fixed WiMAX Commands

11-1 :ABORt Subsystem

The abort subsystem includes commands that allow the user to stop current measurement activities on the instrument.

:ABORt

Title: Abort

Description: Restarts the current sweep and/or measurement. Resets the trigger system. If :INITiate:CONTinuous is OFF (i.e. the instrument is in single sweep mode), send the command :INITiate[:IMMediate] to trigger the next sweep. If :INITiate:CONTinuous is ON (i.e. the instrument is in continuous sweep mode), a new sweep will start immediately.

Parameter: NA

Related Command: :INITiate:CONTinuous
:INITiate[:IMMediate]

11-2 :CONFigure Subsystem

This set of commands prepares the instrument for the selected measurement. It disables any currently-enabled measurements and activates the specified measurement. It sets the instrument to single sweep mode, waiting for an :INITiate command. It will not initiate the taking of a measurement.

Current instrument settings may be changed to default values. These changes are identified with their respective measurement commands.

:CONFigure SUMMary

Title: Configure Summary Measurement

Description: This command configures the summary of all the related numerical measurement results. It disables any other active measurements. None of the instrument parameters are changed by the execution of this command. Sets the instrument to single sweep mode (:INITiate:CONTInuous OFF). Measurement settings can be modified by using the [:SENSE] commands before initiating a measurement.

Parameter: SUMMary

Parameter Type: <char>

Front Panel

Access: Shift-4 (Measure), WiMAX Summary

:CONFigure:DEMod <char>

Title: Configure Demodulation Measurement

Required Option: 47

Description: Valid <char> parameters are:
SUMMary | CONSTln | SFLatness | EVSCarrier | EVSYmbol.

This command configures the selected demodulation measurement. It disables any other active measurements. None of the instrument parameters are changed by the execution of this command. Sets the instrument to single sweep mode (:INITiate:CONTInuous OFF). Measurement settings can be modified by using the [:SENSE]:DEMod commands before initiating a measurement.

When the SUMMARY option is selected, the measurement results are equivalent to the results that are displayed by choosing Measurements, then Demodulator, then Modulation Summary from the front panel. When the CONSTln option is selected, the measurement results are equivalent to the results that are displayed by choosing Measurements, then Demodulator, then Constellation from the front panel. When the SFLatness option is selected, the measurement results are equivalent to the results that are displayed by choosing Measurements, then Demodulator, then Spectral Flatness from the front panel. When the EVSCarrier option is selected, the measurement results are equivalent to the results that are displayed by choosing Measurements, then Demodulator then EVM vs Sub Carrier from the front panel. When the EVSYmbol option is selected, the measurement results are equivalent to the results that are displayed by choosing Measurements, then Demodulator then EVM vs Symbol from the front panel.

Parameter: <char>

Front Panel

Access: Shift-4 (Measure), Demodulator

:CONFigure PFail

Title: Configure PASS/FAIL Measurement

Description: This command configures the PASS/FAIL measurement. It disables any other active measurements. None of the instrument parameters are changed by the execution of this command. Sets the instrument to single sweep mode (:INITiate:CONTinuous OFF). Measurement settings can be modified by using the [:SENSE] commands before initiating a measurement. The measurement results are equivalent to the results that are displayed by choosing Measurements, then PASS/FAIL from the front panel.

Parameter: PFail

Related Command: :FETCh:PFail?
MEASure:PFail?
READ:PFail?

Front Panel

Access: Shift-4 (Measure), Pass/Fail Mode

:CONFigure :RF <char>

Title: Configure RF Measurement

Required Option: 46

Description: Valid parameter options: SUMMary | SPECtrum | PVTTime | ACPR

This command configures the selected RF measurement. It disables any other active measurements. None of the instrument parameters are changed by the execution of this command. Sets the instrument to single sweep mode (:INITiate:CONTinuous OFF). Measurement settings can be modified by using the [:SENSe]:RF commands before initiating a measurement.

When the SUMMary option is selected, the measurement results are equivalent to the results that are displayed by choosing Measurements, then RF, then RF Summary from the front panel. When the SPECTrum option is selected, the measurement results are equivalent to the results that are displayed by choosing Measurements, then RF, then Spectrum from the front panel. When the PVTTime option is selected, the measurement results are equivalent to the results that are displayed by choosing Measurements, then RF, then Power vs Time from the front panel. When the ACPR option is selected, the measurement results are equivalent to the results that are displayed by choosing Measurements, then RF, then ACPR from the front panel.

Parameter: <char>

Related Command: [:SENSe]:FREQuency

11-3 :DISPlay Subsystem

This subsystem provides commands that modify the display of data for the user. They do not modify the way in which data are returned to the controller.

:DISPlay:WINDow:TRACe:MAXHold OFF|ON|0|1

:DISPlay:WINDow:TRACe:MAXHold?

Title: Max Hold State

Description: Specifies whether the Max Hold is ON or OFF. The default value is 0. That is, sending :DISP:WIND:TRAC:MAXH is equivalent to sending :DISP:WIND:TRAC:MAXH ON. The query version of the command returns a 1 if Max Hold is set to ON and returns a 0 if the Max Hold is set to OFF. Note that this command is available only in the Spectrum and EVM vs. Sub-carrier views.

Parameter: OFF|ON|0|1

Parameter Type: <boolean>

Default Value: 0

Related Command: :CONFigure:RF SPECTrum
:CONFigure:DEMod EVSCarrier

Front Panel

Access: Shift-5 (Trace), Max Hold

:DISPlay:WINDow:TRACe:Y[:SCALE]:OFFSet <rel ampl>

:DISPlay:WINDow:TRACe:Y[:SCALE]:OFFSet?

Title: Power Offset

Description: Sets the power offset value for the y-axis.

Parameter: <rel ampl>

Default Value: 0 dB

Default Unit: dB

Range: 0 dB to 100 dB

Front Panel

Access: Amplitude, Power Offset

:DISPlay:WINDow:TRACe:Y[:SCALE]:PDIVision <value>

:DISPlay:WINDow:TRACe:Y[:SCALE]:PDIVision?

Title: Scale Resolution Per Division

Description: Sets the scale per division for the y-axis. The units change from dB/div to % when EVM is the y-axis value. The resolution per division value is maintained separately for each measurement.

Parameter: <value>

Default Value: Spectral Flatness: 1 dB/div
EVM vs. SubCarrier: 0.50%
EVM vs. Symbol: 0.50%
All others: 10dB/div

Default Unit: Current active amplitude unit

Range: EVM vs. SubCarrier: 0.1 % to 10 %
EVM vs. SubCarrier: 0.1 % to 10 %
All others: 1 dB to 15 dB

:DISPlay:WINDow:TRACe:Y[:SCALE]:TOP <amplitude>

:DISPlay:WINDow:TRACe:Y[:SCALE]:TOP?

Title: Y Axis Max

Description: Sets the maximum value of the Y axis. Note that this command is available only in the Spectral Flatness and EVM vs. Symbol/Sub-carrier views.

Parameter: <amplitude>

Default Value: Spectral Flatness: 5dB
EVM vs. Symbol: 5%
EVM vs. Sub-carrier: 5%

Default Unit: Current active amplitude unit

Range: Spectral Flatness: -5 to 5
EVM vs. Symbol: 1 to 100
EVM vs. Sub-carrier: 1 to 100

Front Panel

Access: Amplitude, Y Axis Max

11-4 :FETCh Subsystem

This set of commands returns the most recent measurement data of the active measurement. They will not switch to another measurement.

To make a new measurement, use the INITiate command. To get new measurement data, use the READ or MEASure query commands.

:FETCh:DEMod:CONStln?

Title: Fetch Constellation

Description: Returns the constellation of the demodulated data symbol over one frame measurement results.

Data is returned as 8 comma-delimited values: EVM (rms) in %, EVM (pk) in %, RCE (rms) in dB, RCE (pk) in dB, Carrier Frequency in MHz, Freq Error in MHz, Freq Error in ppm, and the Base Station ID. "--" is returned for each data that is not valid at that instance.

:FETCh:DEMod:EVSCarrier?

Title: Fetch EVM vs. Sub Carrier

Description: Returns the EVM vs. Sub Carrier measurement results.

Data is returned as 8 comma-delimited values: EVM (rms) in %, EVM (pk) in %, RCE (rms) in dB, RCE (pk) in dB, Carrier Frequency in MHz, Freq Error in MHz, Freq Error in ppm, and the Base Station ID. "--" is returned for each data that is not valid at that instance.

:FETCh:DEMod:EVSYmbol?

Title: Fetch EVM vs. Symbol

Description: Returns the EVM vs. Symbol measurement results.

Data is returned as 8 comma-delimited values: EVM (rms) in %, EVM (pk) in %, RCE (rms) in dB, RCE (pk) in dB, Carrier Frequency in MHz, Freq Error in MHz, Freq Error in ppm, and the Base Station ID. "--" is returned for each data that is not valid at that instance.

:FETCh:DEMod:SFLatness?

Title: Fetch Spectral Flatness

Description: Returns the absolute delta of the power between adjacent sub carriers in dB. "--" is returned for data that is not valid at that instance.

:FETCh:PFail?

Title: Fetch PASS/FAIL

Description: Returns the most recent PASS/FAIL measurement results. Measurement results are returned in a block of ASCII text in the format of <header><block>. The ASCII header specifies the number of data bytes. It looks like #AX, where A is the number of digits in X and X is the number of bytes in the <block>. The block consists of a set of records which indicate individual test results. Records are comma-separated. Each record follows the format <test ID>: <input1> <input2> <min> <max> <value1> <value2> <PASS/FAIL/OPTION NOT INSTALLED>. The <test ID> field indicates which test was performed to retrieve these results. The < input1> and < input2> fields indicate the test setup. The <min> and <max> fields indicate the minimum and maximum values against which <value1> and <value2> were compared to arrive at the final PASS/FAIL result. If the specified test is not available in the instrument, the <PASS/FAIL> field will indicate “option not available” instead of “pass” or “fail”. All unused fields for a given test are represented by a double dash (“-”). To receive valid measurements, the Pass/Fail measurement must be the active. The current measurement can be queried using CONFIgure?. Use the :CONFIgure PFail command to set Pass/Fail as the active measurement.

Related Command: MEASure:PFail?
:CONFIgure PFail
READ:PFail?

:FETCh:RF:ACPR?

Title: Fetch Adjacent Channel Power Ratio

Description: Returns the most recent adjacent channel power ratio measurement results.

Data is returned as 11 comma-delimited values: The Channel Power in dBm, relative adjacent channel 1 power level, absolute adjacent channel 1 power level, relative adjacent channel 2 power level, absolute adjacent channel 2 power level, relative adjacent channel 3 power level, absolute adjacent channel 3 power level, relative adjacent channel 4 power level, absolute adjacent channel 4 power level, relative adjacent channel 5 power level, absolute adjacent channel 5 power level. The relative adjacent channel power level is in dB and the absolute adjacent channel power level is in dBm. “-” is returned for each data that is not valid at that instance.

Related Command: :CONFIgure:RF ACPR
:MEASure:RF:ACPR?
:READ:RF:ACPR?

Front Panel

Access: Measurements, RF Measurements, ACPR

:FETCh:RF:PVTime?

Title: Fetch Power vs. Time

Description: Returns the most recent WiMAX 802.16-2004 OFDM signal over approximately one frame time domain measurement results.

Data is returned as 4 comma-delimited values: The Channel Power in dBm, Preamble power in dBm, burst power of data bursts in dBm, and the Crest Factor in dB. "--" is returned for each data that is not valid at that instance.

:FETCh:RF:SPECTrum?

Title: Fetch RF Spectrum

Description: Returns the most recent RF Spectrum measurement results.

Data is returned as 2 comma-delimited values: Channel Power(RSSI) in dBm and Occupied bandwidth measurement in MHz. "--" is returned for each data that is not valid at that instance.

Related Command: :CONFigure:RF SPECTrum
:MEASure:RF:SPECTrum?
:READ:RF:SPECTrum?

Front Panel

Access: Measurements, RF Measurements, Spectrum

11-5 :FORMat Subsystem

This subsystem contains commands that determine the formatting of numeric data when it is transferred.

The format setting affects data in specific commands only. If a command is affected, it is noted in the command description.

:FORMat[:READings][:DATA] ASCii|INTeger,32|REAL,32

:FORMat[:READings][:DATA]?

Title: Numeric Data Format

Description: This command specifies the format in which data is returned in certain commands.

ASCii format returns the data in comma-separated ASCII format. The units are the current instrument units. This format requires many more bytes so it is the slowest format. INTeger 32 values are signed 32-bit integers in little-endian byte order. This format returns the data in 4-byte blocks. REAL,32 values are 32-bit floating point numbers conforming to the IEEE 754 standard in little-endian byte order. This format returns the data in 4-byte binary format. The units are the current instrument units.

Both INTeger,32 and REAL,32 formats return a definite block length. Each transfer begins with an ASCII header such as #42204. The first digit represents the number of following digits in the header (in this example, 4). The remainder of the header indicates the number of bytes that follow the header (in this example, 2204). You then divide the number of following bytes by the number of bytes in the data format you've chosen (4 for both INTeger,32 and REAL,32) to get the number of data points (in this example, 551).

Parameter: ASCii|INTeger,32|REAL,32

Parameter Type: <char>

Default Value: ASCii

Related Command: :TRACe[:DATA]

11-6 :INITiate Subsystem

This subsystem controls the triggering of measurements.

:INITiate:CONTInuous OFF|ON|0|1

:INITiate:CONTInuous?

Title: Continuous/Single Sweep

Description: Specifies whether the sweep/measurement is triggered continuously. If the value is set to ON or 1, another sweep/measurement is triggered as soon as the current one completes. If continuous is set to OFF or 0, the instrument enters the “idle” state and waits for the :INITiate[:IMMEDIATE] command or for :INITiate:CONTInuous ON. The default value is ON. That is, sending :INIT:CONT is equivalent to sending :INIT:CONT ON. The query version of the command returns a 1 if the instrument is continuously sweeping/measuring and returns a 0 if the instrument is in single sweep/measurement mode. Note that rapid toggling between ON and OFF is not allowed. The instrument must be allowed to make a full sweep before toggling can be done.

Parameter: OFF|ON|0|1

Parameter Type: <boolean>

Default Value: ON

Related Command: :INITiate[:IMMEDIATE]
:INITiate:HOLD

Front Panel

Access: Shift-3 (Sweep), Sweep

:INITiate[:IMMEDIATE]

Title: Trigger Sweep/Measurement

Description: Initiates a sweep/measurement. If :INITiate:CONTInuous is set to ON, this command is ignored. Use this command in combination with :STATus:OPERation? to synchronize the capture of one complete set of data. When this command is sent, the “sweep complete” bit of :STATus:OPERation? is set to 0, indicating that the measurement has not completed. The data collection is then triggered. The controlling program can poll :STATus:OPERation? to determine the status. When the “sweep complete” bit is set to 1, data is ready to be retrieved.

Related Command: :INITiate:CONTInuous
:STATus:OPERation?

Front Panel

Access: Shift-3 (Sweep), Trigger Sweep

11-7 :MEASure Subsystem

These commands take the instrument from its current state, enable the specified measurement and put the instrument into single sweep mode. They correct any parameters that are invalid given the new measurement state such that a valid measurement can take place. Other settings may be changed; see the documentation of CONFigure for each measurement. They then initiate the measurement. When the measurement is complete, they return the result.

To make a measurement with settings other than the “default” measurement settings applied by CONFigure, do the following:

- Send the appropriate CONFigure command to set the desired measurement.
- Modify the settings as required.
- Send the appropriate READ command to measure and return the result.

To get the current measurement data, use the appropriate FETCh command.

:MEASure:DEMod:CONStln?

Title: Measure Constellation

Description: Sets the active measurement to Constellation, sets the default measurement parameters, triggers a new measurement, and returns the EVM (rms), EVM (pk), RCE (rms), RCE (pk), Carrier Frequency, Freq Error, Freq Error, and the Base Station ID. It is a combination of the commands :CONFigure:DEMod CONStln and :READ:DEMod:CONStln? To make a Demodulated Constellation measurement with settings other than the default values, send:

```
:CONFigure:DEMod CONStln
Commands to set desired settings
:READ:DEMod:CONStln?
```

Data is returned as 8 comma-delimited values: EVM (rms) in %, EVM (pk) in %, RCE (rms) in dB, RCE (pk) in dB, Carrier Frequency in MHz, Freq Error in MHz, Freq Error in ppm, and the Base Station ID.

Related Command: :READ:DEMod:CONStln?
:CONFigure:DEMod CONStln

:MEASure:DEMod:EVSCarrier?

Title: Measure EVM vs. Sub Carrier

Description: Sets the active measurement to EVM vs. Sub Carrier, sets the default measurement parameters, triggers a new measurement, and returns the EVM (rms), EVM (pk), RCE (rms), RCE (pk), Carrier Frequency, Freq Error, Freq Error, and the Base Station ID. It is a combination of the commands :CONFigure:DEMod EVSCarrier and :READ:DEMod:EVSCarrier? To make an EVM vs. Symbol measurement with settings other than the default values, send:

```
:CONFigure:DEMod EVSCarrier
Commands to set the desired settings
:READ:DEMod:EVSCarrier?
```

Data is returned as 8 comma-delimited values: EVM (rms) in %, EVM (pk) in %, RCE (rms) in dB, RCE (pk) in dB, Carrier Frequency in MHz, Freq Error in MHz, Freq Error in ppm, and the Base Station ID.

Related Command: :READ:DEMod:EVSCarrier?
:CONFigure:DEMod EVSCarrier

:MEASure:DEMod:EVSYmbol?

Title: Measure EVM vs. Symbol

Description: Sets the active measurement to EVM vs. Symbol, sets the default measurement parameters, triggers a new measurement, and returns the EVM (rms), EVM (pk), RCE (rms), RCE (pk), Carrier Frequency, Freq Error, Freq Error, and the Base Station ID. It is a combination of the commands :CONFigure:DEMod EVSYmbol and :READ:DEMod:EVSYmbol? To make an EVM vs. Symbol measurement with settings other than the default values, send:

:CONFigure:DEMod EVSYmbol
Commands to set the desired settings
:READ:DEMod:EVSYmbol?

Data is returned as 8 comma-delimited values: EVM (rms) in %, EVM (pk) in %, RCE (rms) in dB, RCE (pk) in dB, Carrier Frequency in MHz, Freq Error in MHz, Freq Error in ppm, and the Base Station ID.

Related Command: :READ:DEMod:EVSYmbol?
:CONFigure:DEMod EVSYmbol

:MEASure:DEMod:SFLatness?

Title: Measure Spectral Flatness

Description: Sets the active measurement to Spectral Flatness, sets the default measurement parameters, triggers a new measurement, and returns the absolute delta of the power between adjacent sub carriers in dB. It is a combination of the commands :CONFigure:DEMod SFLatness and :READ:DEMod:SFLatness? To make a Spectral Flatness measurement with settings other than the default values, send:

:CONFigure:DEMod SFLatness
Commands to set desired settings
:READ:DEMod:SFLatness?

Related Command: :READ:DEMod:SFLatness?
:CONFigure:DEMod SFLatness

:MEASure:PFail?

Title: Measure PASS/FAIL

Description: Sets the active measurement to PASS/FAIL, sets the default measurement parameters, triggers a new measurement and returns the PASS/FAIL results. It is a combination of the commands :CONFigure PFail and :READ:PFail? To make a PASS/FAIL measurement with settings other than the default values, send:

```
:CONFigure PFail
Commands to set desired settings
:READ:PFail?
```

Related Command: :CONFigure PFail
 READ:PFail?
 FETCh:PFail?

Front Panel

Access: Shift-4 (Measure), Pass/Fail Mode

:MEASure:RF:ACPR?

Title: Measure Adjacent Channel Power Ratio

Description: Sets the active measurement to ACPR, sets the default measurement parameters, triggers a new measurement, and returns the power levels for each channel (both absolute and relative). It is a combination of the commands :CONFigure:RF ACPR and :READ:RF:SPECTrum? To make an RF ACPR measurement with settings other than the default values, send:

```
:CONFigure:RF ACPR
Commands to set desired settings
:READ:RF:ACPR?
```

Data is returned as 11 comma-delimited values: The Channel Power in dBm, relative adjacent channel 1 power level, absolute adjacent channel 1 power level, relative adjacent channel 2 power level, absolute adjacent channel 2 power level, relative adjacent channel 3 power level, absolute adjacent channel 3 power level, relative adjacent channel 4 power level, absolute adjacent channel 4 power level, relative adjacent channel 5 power level, absolute adjacent channel 5 power level. The relative adjacent channel power level is in dB and the absolute adjacent channel power level is in dBm.

Related Command: :READ:RF:ACPR?
 :CONFigure:RF ACPR
 :FETCh:RF:ACPR?

Front Panel

Access: Measurements, RF Measurements, ACPR

:MEASure:RF:PVTime?

Title: Measure Power vs. Time

Description: Sets the active measurement to Power vs. Time, sets the default measurement parameters, triggers a new measurement and returns the Channel Power, Preamble power, burst power of data bursts, and the Crest Factor. It is a combination of the commands :CONFigure:RF PVTime and :READ:RF:PVTime? To make an RF ACPR measurement with settings other than the default values, send:

:CONFigure:RF PVTime

Commands to set desired settings

:READ:RF:PVTime?

Data is returned as 4 comma-delimited values: The Channel Power in dBm, Preamble power in dBm, burst power of data bursts in dBm, and the Crest Factor in dB.

Related Command: :READ:RF:PVTime?
:CONFigure:RF PVTime

:MEASure:RF:SPECTrum?

Title: Measure RF Spectrum

Description: Sets the active measurement to Spectrum, sets the default measurement parameters, triggers a new measurement and returns the Channel Power (RSSI) and Occupied bandwidth measurement. It is a combination of the commands :CONFigure:RF SPECTrum and :READ:RF:SPECTrum? To make an RF Spectrum measurement with settings other than the default values, send:

:CONFigure:RF SPECTrum

Commands to set desired settings

:READ:RF:SPECTrum?

Data is returned as 2 comma-delimited values: Channel Power (RSSI) in dBm Occupied bandwidth measurement in MHz.

Related Command: :CONFigure:RF SPECTrum
:READ:RF:SPECTrum?
:FETCh:RF:SPECTrum?

Front Panel

Access: Measurements, RF Measurements, Spectrum

11-8 :MMEMory Subsystem

The Mass Memory subsystem contains functions that provide access to the instrument's setup and data storage.

:MMEMory:DELeTe <filename>

Title: Delete Setup/Measurement

Description: Removes a file specified by <filename> from the current mass storage device. <filename> should be enclosed in either single quotes (') or double quotes (") and it must include the file extension. Use the command MMEMory:MSIS to set the current file location.

Parameter: <filename>

Related Command: :MMEMory:STORe:STATe
:MMEMory:STORe:TRACe
:MMEMory:MSIS INTernal|USB

Front Panel

Access: Shift-7 (File), Delete, Delete Selected File

:MMEMory:LOAD:STATe <integer>,<filename>

Title: Recall Setup

Description: Recalls a previously stored instrument setup in the current save location. The setup file to be loaded is specified by <filename>. <filename> should be enclosed in either single quotes (') or double quotes (") and should contain a file extension ".stp". Use the command MMEMory:MSIS to set the current save location. The <integer> parameter is not currently used, but it must be sent. Send a 1.

Parameter: <integer>, <filename>

Related Command: :MMEMory:STORe:STATe
:MMEMory:MSIS INTernal|USB

Front Panel

Access: Shift-7 (File), Recall

:MMEMory:LOAD:TRACe <integer>,<filename>

Title: Recall Measurement

Description: The instrument must be in the mode of the saved trace in order to recall that trace. Use :INSTRument:SELeCt or :INSTRument:NSELeCt to set the mode. Recalls a previously stored measurement trace from the current save location. The saved measurement trace to be loaded is specified by <filename>. <filename> should be enclosed in either single quotes (') or double quotes (") and should contain a file extension. Note that the trace specified by <filename> should be available at the current save location. Use the command MMEMory:MSIS to set the current save location. The <integer> parameter is not currently used, but it must be sent. Send a 1.

File name extensions:

“.edg” for GSM
 “.spa” for SPA
 “.wcd” for WCDMA
 “.wmxd” for WiMAX
 “.wmx” for Mobile WiMAX
 “.vna” for Cable & Antenna
 “.cdma” for CDMA
 “.tds” for TDSCDMA
 “.evdo” for EVDO
 “.ia” for Interference Analysis
 “.cs” for Channel Scanner
 “.pm” for Power Meter
 “.tm” for Transmission Measurement
 “.lte” for LTE Analyzer

Note: Extensions not available for T1 and Hi_PM.

Parameter: <integer>, <filename>

Example: To recall trace with file name “trace”:

```
:MMEMory:LOAD:TRACe 1,"trace.spa"
```

Related Command: :MMEMory:STORe:TRACe
 :MMEMory:STORe:TRACe
 :MMEMory:MSIS INTernal|USB

Front Panel

Access: Shift-7 (File), Recall Measurement

:MMEMory:STORe:STATe <integer>,<filename>

Title: Save Setup

Description: Stores the current setup into the file specified by <filename>. <filename> should be enclosed in either single quotes (') or double quotes (") and should not contain a file extension. Use the command MMEMory:MSIS to set the current save location. The <integer> parameter is not currently used, but it must be sent. Send a value of 0.

Parameter: <integer>, <filename>

Related Command: :MMEMory:LOAD:STATe
 :MMEMory:MSIS INTernal|USB

Front Panel

Access: Shift-7 (File)

:MMEMory:STORe:TRACe <integer>,<filename>

Title: Save Measurement

Description: Stores the trace into the file specified by <filename>. <filename> should be enclosed in either single quotes (' ') or double quotes (" ") and should not contain a file extension. Use the command MMEMory:MSIS to set the current save location. The <integer> parameter is not currently used, but it must be sent. Send a 0. Note that existing files of the same name will not be overwritten.

Parameter: <integer>, <filename>

Example: To save the trace into the file name "trace":

```
:MMEMory:STORe:TRACe 0,"trace"
```

Related Command: :MMEMory:LOAD:TRACe
:MMEMory:MSIS INTernal|USB

Front Panel

Access: Shift-7 (File), Save

11-9 :READ Subsystem

This set of commands combines the ABORT, INITiate and FETCh commands. It aborts any current triggering sequence and sets the trigger state to idle. It then initiates a new active measurement (i.e. begins the collection of new data). When the measurement is complete, it returns the result. These commands will not switch to another measurement.

To get the current measurement data, use the FETCh command.

:READ:DEMod:CONStln?

Title: Read Constellation

Description: Triggers a new Constellation measurement and returns the results: EVM (rms), EVM (pk), RCE (rms), RCE (pk), Carrier Frequency, Freq Error, Freq Error, and the Base Station ID. The Constellation measurement must be the active measurement (specified by :CONFigure:DEMod CONStln). The current measurement can be queried using the command :CONFigure?

Data is returned as 8 comma-delimited values: EVM (rms) in %, EVM (pk) in %, RCE (rms) in dB, RCE (pk) in dB, Carrier Frequency in MHz, Freq Error in MHz, Freq Error in ppm, and the Base Station ID.

Related Command: :FETCh:DEMod:CONStln?
:CONFigure:DEMod CONStln

:READ:DEMod:EVSCarrier?

Title: Read EVM vs. Sub Carrier

Description: Triggers a new EVM vs. Sub Carrier measurement and returns the results: EVM (rms), EVM (pk), RCE (rms), RCE (pk), Carrier Frequency, Freq Error, Freq Error, and the Base Station ID. The EVM vs. Sub Carrier measurement must be the active measurement (specified by :CONFigure:DEMod EVSCarrier). The current measurement can be queried using the command :CONFigure?

Data is returned as 8 comma-delimited values: EVM (rms) in %, EVM (pk) in %, RCE (rms) in dB, RCE (pk) in dB, Carrier Frequency in MHz, Freq Error in MHz, Freq Error in ppm, and the Base Station ID.

Related Command: :FETCh:DEMod:EVSCarrier?
:CONFigure:DEMod EVSCarrier

:READ:DEMod:EVSYmbol?

Title: Read EVM vs. Symbol

Description: Triggers a new EVM vs. Symbol measurement and returns the results: EVM (rms), EVM (pk), RCE (rms), RCE (pk), Carrier Frequency, Freq Error, Freq Error, and the Base Station ID. The EVM vs. Symbol measurement must be the active measurement (specified by :CONFigure:DEMod EVSYmbol). The current measurement can be queried using the command :CONFigure?

Data is returned as 8 comma-delimited values: EVM (rms) in %, EVM (pk) in %, RCE (rms) in dB, RCE (pk) in dB, Carrier Frequency in MHz, Freq Error in MHz, Freq Error in ppm, and the Base Station ID.

Related Command: :FETCh:DEMod:EVSymbol?
:CONFigure:DEMod EVSymbol

:READ:DEMod:SFlatness?

Title: Read Spectral Flatness

Description: Triggers a new Spectral Flatness measurement and returns the absolute delta of the power between adjacent sub carriers in dB. The Spectral Flatness measurement must be the active measurement (specified by :CONFigure:DEMod SFlatness). The current measurement can be queried using the command :CONFigure?

Related Command: :FETCh:DEMod:SFlatness?
:CONFigure:DEMod SFlatness

:READ:PFail?

Title: Read PASS/FAIL

Description: Triggers a new PASS/FAIL measurement and returns the results. It is a combination of the commands :ABORT; :INITiate; :FETCh:PFail? The PASS/FAIL measurement must be active. The current measurement can be queried using :CONFigure?

Related Command: :FETCh:PFail?
:CONFigure PFail
:MEASure:PFail?

Front Panel

Access: Measurements, Pass/Fail Mode

:READ:RF:ACPR?

Title: Read Adjacent Channel Power Ratio

Description: Triggers a new Adjacent Channel Power Ratio measurement and returns the results: Power levels for each channel (both absolute and relative). It is a combination of the commands :ABORT; :INITiate; :FETCh:RF:ACPR? The ACPR measurement must be the active measurement (specified by :CONFigure:RF ACPR). The current measurement can be queried using :CONFigure?

Data is returned as 11 comma-delimited values: The Channel Power in dBm, relative adjacent channel 1 power level, absolute adjacent channel 1 power level, relative adjacent channel 2 power level, absolute adjacent channel 2 power level, relative adjacent channel 3 power level, absolute adjacent channel 3 power level, relative adjacent channel 4 power level, absolute adjacent channel 4 power level, relative adjacent channel 5 power level, absolute adjacent channel 5 power level. The relative adjacent channel power level is in dB and the absolute adjacent channel power level is in dBm.

Related Command: :FETCh:RF:ACPR?
:CONFigure:RF ACPR
:MEASure:RF:ACPR?

Front Panel

Access: Measurements, RF Measurements, ACPR

:READ:RF:PVTime?

Title: Read Power vs. Time

Description: Triggers a new Power vs. Time measurement and returns the results: Channel Power, Preamble power, burst power of data bursts, and the Crest Factor. It is a combination of the commands :ABORT; :INITiate; :FETCh:RF:PVTime? The Power vs. Time measurement must be the active measurement (specified by :CONFigure:RF PVTime). The current measurement can be queried using :CONFigure?

Data is returned as 4 comma-delimited values: The Channel Power in dBm, Preamble power in dBm, burst power of data bursts in dBm, and the Crest Factor in dB.

Related Command: :FETCh:RF:PVTime?
:CONFigure:RF PVTime

:READ:RF:SPECTrum?

Title: Read RF Spectrum

Description: Triggers a new RF Spectrum measurement and returns the results: Channel Power (RSSI) and Occupied bandwidth measurement. It is a combination of the commands :ABORT; :INITiate; :FETCh:RF:SPECTrum? The Spectrum measurement must be the active measurement (specified by :CONFigure:RF SPECTrum). The current measurement can be queried using :CONFigure?

Data is returned as 2 comma-delimited values: Channel Power(RSSI) in dBm and Occupied bandwidth measurement in MHz.

Related Command: :FETCh:RF:SPECTrum?
:CONFigure:RF SPECTrum
:MEASure:RF:SPECTrum?

11-10 :TRACe Subsystem

This subsystem contains commands related to the transfer of trace data to and from the instrument.

:TRACe:PREamble? <trace type>

Title: Returns trace header information for the specified trace. The <trace type> must be one of the following:
SPECTrum | PVTTime | ACPR | CONSTln | SFLatness | EVSCarrier | EVSYmbol

Data can be transferred to and from the 7 available display trace types. Use the commands in the MMEMOry subsystem to store and recall traces from the instrument memory. The response begins with an ASCII header. The header specifies the number of following bytes. It looks like #AX, where A is the number of digits in X and X is the number of bytes that follow the header. Parameters are returned in comma-delimited ASCII format. Each parameter is returned as "NAME=VALUE[UNITS]," Valid parameter names are shown in Chapter 2.

Parameter: <trace type>

Related Command: :TRACe:DATA?

:TRACe[:DATA]? <trace type>

Title: Trace Data Transfer

Description: This command transfers trace data from the instrument to the controller. The <trace type> must be one of the following:
SPECTrum | PVTTime | CONSTln | SFLatness | EVSCarrier | EVSYmbol.

The format of the block data in the query form is specified by :FORMat:DATA. The block data in the command form is always sent in ASCII format. The response begins with an ASCII header that specifies the number of data bytes. It looks like #AX, where A is the number of digits in X and X is the number of bytes that follow the header. Each data point is separated by a comma delimiter. Trace setup information can be acquired using :TRACe[:DATA]:PREamble?.

Use the commands in the MMEMory subsystem to store and recall traces from the instrument memory. Except for CONSTln there is only one value per data point. If max hold is set to ON for SPECTrum and EVM vs. Sub Carrier then the max hold value is returned. For CONSTln, each data point is represented by 3 values 4 bytes each: IData (no units), QData (no units), and the constellation type (no units). For SPECTrum and PVTime unit is in dBm. For Spectral Flatness unit is in dB. For EVM vs Sub Carrier and EVM vs Symbol unit is in percent. Note that the instrument must be set in the selected view. Use the CONFigure command to set the unit to the selected view.

Parameter: <trace type>

Related Command: :FORMat [:DATA]
:TRACe [:DATA] :PREamble?

11-11 [:SENSE] Subsystem

The commands in this subsystem relate to device-specific parameters, not signal-oriented parameters.

[:SENSE]:BANDwidth|BWIDth[:RESolution] <index>

[:SENSE]:BANDwidth|BWIDth[:RESolution]?

Title: Resolution Bandwidth

Description: Sets the resolution bandwidth. The <index> argument is a 1-based index of the position of the desired bandwidth in the instrument's current bandwidth list. The list can be displayed on the instrument by choosing the "BW" submenu button in the "Setup" menu. For example, if the desired bandwidth is the 3rd item on the list, then the value of the <index> argument would be 3.

The query form of this command will return the index of the currently selected bandwidth on the list. The Default is the 1st index in the bandwidth list.

Parameter: <index>

Default Value: The default bandwidth is 1.25MHz which is the 1st index in the bandwidth list.

Front Panel

Access: Setup, BW

[:SENSE]:CPRatio <index>

[:SENSE]:CPRatio?

Title: Cyclic Prefix Ratio (G)

Description: Selects the desired Cyclic Prefix Ratio from the list. The <index> argument is a 1-based index of the position of the desired CP Ratio in the instrument's current CP Ratio list. The list can be displayed on the instrument by choosing the "CP Ratio (G)" submenu button in the "Setup" menu. For example, if the desired CP Ratio is the 3rd item on the list, then the value of the <index> argument would be 3.

The query form of this command will return the index of the currently selected CP Ratio on the list. The default CP ratio is the first index in the CP ratio list.

Parameter: <index>

Default Value: The default CP Ratio is 1/4 which is the 1st index in the CP Ratio list.

Front Panel

Access: Setup, CP Ratio (G)

[:SENSE]:DEMod:CONStln:POINTs?

Title: Number of Constellation Point

Required Option: 47

Description: Queries the number of Constellation points.

[:SENSE]:DEMod:CONStln:REFPoints[:STATe] OFF|ON|0|1**[:SENSE]:DEMod:CONStln:REFPoints[:STATe]?**

Title: Constellation Reference Points

Required Option: 47

Description: Sets the display of the reference points for the various constellations on/off. The query will return 1 for ON and 0 for OFF.

Parameter: OFF|ON|0|1

Parameter Type: <boolean>

Default Value: 1

Front Panel

Access: Shift 4 (Measure), Demodulator, Constellation, Reference Points

[:SENSE]:DEMod:EVSCarrier:START:X?

Title: EVM vs. Sub Carrier Start Value

Description: Queries the EVM vs. Sub Carrier start value.

Related Command: [:SENSE]:DEMod:EVSCarrier:STOP:X?

[:SENSE]:DEMod:EVSCarrier:STOP:X?

Title: EVM vs. Sub Carrier Stop Value

Description: Queries the EVM vs. Sub Carrier stop value.

Related Command: [:SENSE]:DEMod:EVSCarrier:START:X?

[:SENSE]:DEMod:EVSYmbol:START:X?

Title: EVM vs. Symbol Start Value

Description: Queries the EVM vs. Symbol start value.

Related Command: [:SENSE]:DEMod:EVSYmbol:STOP:X?

[:SENSE]:DEMod:EVSYmbol:STOP:X?

Title: EVM vs. Symbol Stop Value

Description: Queries the EVM vs. Symbol stop value.

Related Command: [:SENSE]:DEMod:EVSYmbol:START:X?

[:SENSE]:DEMod:SFLatness:START:X?

Title: Spectral Flatness Start Value

Description: Queries the Spectral Flatness start value.

Related Command: [:SENSE]:DEMod:SFLatness:STOP:X?

[:SENSE]:DEMod:SFLatness:STOP:X?

Title: Spectral Flatness Stop Value

Description: Queries the Spectral Flatness stop value.

Related Command: [:SENSE]:DEMod:SFLatness:START:X?

[:SENSE]:DLFLength 2.5|5|10**[:SENSE]:DLFLength?**

Title: Down Link Frame Length

Description: Set the Down Link Frame Length. Setting the length to 2.5 will result in setting the Frame Length to 2.5 ms. Setting the length to 5 will result in setting the Frame Length to 5 ms. Setting the length to 10 will result in setting the Frame Length to 10 ms.

The query form of this command will return the Down Link Frame Length in unit of seconds.

Parameter: 2.5|5|10

Default Value: 2500 us

Default Unit: seconds

Front Panel

Access: Setup, Frame Length

[:SENSE]:FREQuency:CENTer <freq>**[:SENSE]:FREQuency:CENTer?**

Title: Center Frequency

Description: Sets the center frequency. Note that changing the value of the center frequency will change the value of the coupled parameters Start Frequency and Stop Frequency.

Parameter: <freq>

Default Value: 2.5 GHz

Default Unit: Hz

Range: 0 Hz to 7.1 GHz

Front Panel

Access: Freq, Center Freq

[:SENSE]:FREQUENCY:SIGStandard:CHANNEL <number>

[:SENSE]:FREQUENCY:SIGStandard:CHANNEL?

Title: Channel Selection

Description: Sets the channel number for the selected signal standard.

Parameter: <number>

Front Panel

Access: Freq, Channel

[:SENSE]:FREQUENCY:SIGStandard:NAME <string>

[:SENSE]:FREQUENCY:SIGStandard:NAME?

Title: Signal Standard

Description: Selects the desired signal standard from the list. The <string> argument is the name of the desired signal standard as displayed in the instrument's current signal standard list. The list can be displayed on the instrument by choosing the Signal Standard submenu button in the Freq menu. The list can also be downloaded remotely and viewed using Anritsu Master Software Tools. For example, if the desired Signal Standard is P-GSM 900 - Uplink, then the value of the <string> argument would be "P-GSM 900 - Uplink".

The query form of this command will return the name of the currently selected Signal Standard on the list.

Parameter: <string>

Front Panel

Access: Freq, Signal Standard

[:SENSE]:PFail <test set>

[:SENSE]:PFail?

Title: PASS/FAIL Test Selection

Description: Selects the active test set to be used in subsequent PASS/FAIL measurements. The <test set> value must correspond to a test set that is defined in the test set list. To view the list on the instrument, go into the "Measurement" menu, press the "Pass/Fail Mode" key, and then press the "Select Pass/Fail Test" submenu. Alternatively, the list can be retrieved remotely and viewed using the Anritsu Master Software Tools. The <test set> argument is a 1-based index of the position of the desired Pass/Fail test set in the instrument's current Pass/Fail test set list. For example, if the desired Pass/Fail test is the 3rd item on the list, then the value of the <test set> argument would be 3.

When using the query form of the command, the return value is the currently selected test set number. If there is not a valid test set selected, the return value is "-1" (negative 1).

Parameter: <test set>

Related Command: :CONFigure PFail

Front Panel

Access: Measurements, Pass/Fail Mode, Select Pass/Fail Test

[:SENSe]:POWer[:RF]:RANGe:AUTO OFF|ON|0|1

[:SENSe]:POWer[:RF]:RANGe:AUTO?

Title: Automatic Amplitude Range

Description: Sets the automatic amplitude range. Setting the value to ON or 1 will result in the amplitude range being coupled to the detected input signal level. Setting the value to OFF or 0 will result in the input attenuation being un-coupled from the input signal level. That is, changing the input signal level will not change the amplitude range. When this command is issued, the amplitude range itself will not change. The default value is ON. That is, sending :SENS:POW:RANG:AUTO is equivalent to sending :SENS:POW:RANG:AUTO ON.

Parameter: OFF|ON|0|1

Parameter Type: <boolean>

Default Value: ON

Related Command: [:SENSe]:POWer[:RF]:RANGe

Front Panel

Access: Amplitude, Auto Range

[:SENSe]:POWer[:RF]:RANGe[:IMMediate]

Title: Amplitude Range

Description: Re-calculates amplitude range. Note that issuing this command will set the automatic dynamic range OFF.

Related Command: [:SENSe]:POWer[:RF]:RANGe:AUTO

Front Panel

Access: Amplitude, Adjust Range

[:SENSe]:RF:ACPR:ADJCchannelcount?

Title: ACPR ADJC Channel Count

Description: Returns the number of Adjacent channels in the ACPR view.

Range: 1 to 4

[:SENSE]:RF:ACPR:MAINchannelcount?

Title: ACPR MAIN Channel Count

Description: Returns the number of main channels in the ACPR view.

Range: 1 to 4

[:SENSE]:RF:PVTime:FRAME:START?

Title: Power vs. Time Frame Start Time

Description: Queries the Power vs. Time Frame start time.

Default Unit: seconds

Related Command: [:SENSE]:RF:PVTime:FRAME:STOP?
[:SENSE]:DLFLength?

[:SENSE]:RF:PVTime:FRAME:STOP?

Title: Power vs. Time Frame Stop Time

Description: Queries the Power vs. Time frame stop time.

Default Unit: seconds

Related Command: [:SENSE]:RF:PVTime:FRAME:START?
[:SENSE]:DLFLength?

[:SENSE]:RF:SPECTrum:SPAN 5|10|20|30**[:SENSE]:RF:SPECTrum:SPAN?**

Title: Spectrum View Span

Description: Sets the span for the Spectrum view. Setting the value to 5 will set the span for the Spectrum view to 5 MHz. Setting the value to 10 will set the span for the Spectrum view to 10 MHz. Setting the value to 20 will set the span for the Spectrum view to 20MHz. Setting the value to 30 will set the span for the Spectrum view to 30MHz.

Parameter: 5|10|20|30

Default Value: 5 MHz

Default Unit: MHz

Front Panel

Access: Measurements, RF Measurements, Spectrum, Span

Chapter 12 — Mobile WiMAX Commands

12-1 :ABORt Subsystem

The abort subsystem includes commands that allow the user to stop current measurement activities on the instrument.

:ABORt

Title: Abort

Description: Restarts the current sweep and/or measurement. Resets the trigger system. If :INITiate:CONTinuous is OFF (i.e. the instrument is in single sweep mode), send the command :INITiate[:IMMediate] to trigger the next sweep. If :INITiate:CONTinuous is ON (i.e. the instrument is in continuous sweep mode), a new sweep will start immediately.

Parameter: NA

Related Command: :INITiate:CONTinuous
:INITiate[:IMMediate]

12-2 :CONFigure Subsystem

This set of commands prepares the instrument for the selected measurement. It disables any currently-enabled measurements and activates the specified measurement. It sets the instrument to single sweep mode, waiting for an :INITiate command. It will not initiate the taking of a measurement.

Current instrument settings may be changed to default values. These changes are identified with their respective measurement commands.

:CONFigure PFail

Title: Configure PASS/FAIL Measurement

Description: This command configures the PASS/FAIL measurement. It disables any other active measurements. None of the instrument parameters are changed by the execution of this command. Sets the instrument to single sweep mode (:INITiate:CONTinuous OFF). Measurement settings can be modified by using the [:SENSE] commands before initiating a measurement. The measurement results are equivalent to the results that are displayed by choosing Measurements, then PASS/FAIL from the front panel.

Parameter: PFail

Related Command: :FETCh:PFail?
MEASure:PFail?
READ:PFail?

Front Panel

Access: Measurements, Pass/Fail Mode

:CONFigure SUMMary

Title: Configure Summary Measurement

Description: This command configures the summary of all the related numerical measurement results. It disables any other active measurements. None of the instrument parameters are changed by the execution of this command. Sets the instrument to single sweep mode (:INITiate:CONTinuous OFF). Measurement settings can be modified by using the [:SENSE] commands before initiating a measurement.

Parameter: SUMMary

Parameter Type: <char>

Front Panel

Access: Measurements, WiMAX Summary

:CONFigure:DEMod <char>

Title: Configure Demodulation Measurement

Required Option: 47

Description: Valid <char> parameters are:
SUMMary | CONSTln | SFLatness | EVSCarrier | EVSYmbol.

This command configures the selected demodulation measurement. It disables any other active measurements. None of the instrument parameters are changed by the execution of this command. Sets the instrument to single sweep mode (:INITiate:CONTinuous OFF). Measurement settings can be modified by using the [:SENSE]:DEMod commands before initiating a measurement.

When the SUMMARY option is selected, the measurement results are equivalent to the results that are displayed by choosing Measurements, then Demodulator, then Modulation Summary from the front panel. When the CONSTln option is selected, the measurement results are equivalent to the results that are displayed by choosing Measurements, then Demodulator, then Constellation from the front panel. When the SFLatness option is selected, the measurement results are equivalent to the results that are displayed by choosing Measurements, then Demodulator, then Spectral Flatness from the front panel. When the EVSCarrier option is selected, the measurement results are equivalent to the results that are displayed by choosing Measurements, then Demodulator then EVM vs Sub Carrier from the front panel. When the EVSYmbol option is selected, the measurement results are equivalent to the results that are displayed by choosing Measurements, then Demodulator then EVM vs Symbol from the front panel.

Parameter: <char>

Front Panel

Access: Measurements, Demodulator

:CONFigure:RF <char>

Title: Configure RF Measurement

Required Option: 46

Description: Valid parameter options: SUMMary | SPECTrum | PVTime | ACPR

This command configures the selected RF measurement. It disables any other active measurements. None of the instrument parameters are changed by the execution of this command. Sets the instrument to single sweep mode (:INITiate:CONTinuous OFF). Measurement settings can be modified by using the [:SENSE]:RF commands before initiating a measurement.

When the SUMMary option is selected, the measurement results are equivalent to the results that are displayed by choosing Measurements, then RF, then RF Summary from the front panel. When the SPECTrum option is selected, the measurement results are equivalent to the results that are displayed by choosing Measurements, then RF, then Spectrum from the front panel. When the PVTime option is selected, the measurement results are equivalent to the results that are displayed by choosing Measurements, then RF, then Power vs Time from the front panel. When the ACPR option is selected, the measurement results are equivalent to the results that are displayed by choosing Measurements, then RF, then ACPR from the front panel.

Parameter: <char>

Related Command: [:SENSe]:FREQuency

12-3 :DISPlay Subsystem

This subsystem provides commands that modify the display of data for the user. They do not modify the way in which data are returned to the controller.

:DISPlay:WINDow:TRACe:MAXHold OFF|ON|0|1

:DISPlay:WINDow:TRACe:MAXHold?

Title: Max Hold State

Description: Specifies whether the Max Hold is ON or OFF. The default value is ON. That is, sending :DISP:WIND:TRAC:MAXH is equivalent to sending :DISP:WIND:TRAC:MAXH ON. The query version of the command returns a 1 if Max Hold is set to ON and returns a 0 if the Max Hold is set to OFF. Note that this command is available only in the Spectrum and EVM vs. Sub-carrier views.

Parameter: OFF|ON|0|1

Parameter Type: <boolean>

Default Value: 0

Front Panel

Access: Shift-5 (Trace), Max Hold

:DISPlay:WINDow:TRACe:Y[:SCALE]:OFFSet <rel ampl>

:DISPlay:WINDow:TRACe:Y[:SCALE]:OFFSet?

Title: Power Offset

Description: Sets the power offset value for the y-axis.

Parameter: <rel ampl>

Default Value: 0 dB

Default Unit: dB

Range: 0 dB to 100 dB

Front Panel

Access: Amplitude, Power Offset

:DISPlay:WINDow:TRACe:Y[:SCALE]:PDIVision <value>

:DISPlay:WINDow:TRACe:Y[:SCALE]:PDIVision?

Title: Scale Resolution Per Division

Description: Sets the scale per division for the y-axis. The units change from dB/div to % when EVM is the y-axis value. The resolution per division value is maintained separately for each measurement.

Parameter: <value>

Default Value: Spectral Flatness: 1 dB/div
EVM vs. SubCarrier: 0.50%
EVM vs. Symbol: 0.50%
All others: 10dB/div

Default Unit: Current active amplitude unit

Range: EVM vs. SubCarrier: 0.1 % to 10 %
EVM vs. SubCarrier: 0.1 % to 10 %
All others: 1 dB to 15 dB

:DISPlay:WINDow:TRACe:Y[:SCALE]:TOP <amplitude>

:DISPlay:WINDow:TRACe:Y[:SCALE]:TOP?

Title: Y Axis Max

Description: Sets the maximum value of the Y axis. Note that this command is available only in the Spectral Flatness and EVM vs. Symbol/Sub-carrier views.

Parameter: <amplitude>

Default Value: Spectral Flatness: 5dB
EVM vs. Symbol: 5%
EVM vs. Sub-carrier: 5%

Default Unit: Current active amplitude unit

Range: Spectral Flatness: -5dB to 5dB
EVM vs. Symbol: 1% to 100%
EVM vs. Sub-carrier: 1% to 100%

Front Panel

Access: Amplitude, Y Axis Max

12-4 :FETCh Subsystem

This set of commands returns the most recent measurement data of the active measurement. They will not switch to another measurement.

To make a new measurement, use the INITiate command. To get new measurement data, use the READ or MEASure query commands.

:FETCh:DEMod:CONStln?

Title: Fetch Constellation

Description: Returns the constellation of the demodulated data symbol over one frame measurement results.

Data is returned as 8 comma-delimited values: EVM (rms) in %, EVM (pk) in %, RCE (rms) in dB, RCE (pk) in dB, Carrier Frequency in MHz, Freq Error in MHz, Freq Error in ppm, and the Base Station ID. "--" is returned for each data that is not valid at that instance.

:FETCh:DEMod:EVSCarrier?

Title: Fetch EVM vs. Sub Carrier

Description: Returns the EVM vs. Sub Carrier measurement results.

Data is returned as 8 comma-delimited values: EVM (rms) in %, EVM (pk) in %, RCE (rms) in dB, RCE (pk) in dB, Carrier Frequency in MHz, Freq Error in MHz, Freq Error in ppm, and the Base Station ID. "--" is returned for each data that is not valid at that instance.

:FETCh:DEMod:EVSYmbol?

Title: Fetch EVM vs. Symbol

Description: Returns the EVM vs. Symbol measurement results.

Data is returned as 8 comma-delimited values: EVM (rms) in %, EVM (pk) in %, RCE (rms) in dB, RCE (pk) in dB, Carrier Frequency in MHz, Freq Error in MHz, Freq Error in ppm, and the Base Station ID. "--" is returned for each data that is not valid at that instance.

:FETCh:DEMod:SFLatness?

Title: Fetch Spectral Flatness

Description: Returns the absolute delta of the power between adjacent sub carriers in dB. "--" is returned for data that is not valid at that instance.

:FETCh:PFail?

Title: Fetch PASS/FAIL

Description: Returns the most recent PASS/FAIL measurement results. Measurement results are returned in a block of ASCII text in the format of <header><block>. The ASCII header specifies the number of data bytes. It looks like #AX, where A is the number of digits in X and X is the number of bytes in the <block>. The block consists of a set of records which indicate individual test results. Records are comma-separated. Each record follows the format <test ID>: <input1> <input2> <min> <max> <value1> <value2> <PASS/FAIL/OPTION NOT INSTALLED>. The <test ID> field indicates which test was performed to retrieve these results. The < input1> and < input2> fields indicate the test setup. The <min> and <max> fields indicate the minimum and maximum values against which <value1> and <value2> were compared to arrive at the final PASS/FAIL result. If the specified test is not available in the instrument, the <PASS/FAIL> field will indicate “option not available” instead of “pass” or “fail”. All unused fields for a given test are represented by a double dash (“-”). To receive valid measurements, the Pass/Fail measurement must be the active. The current measurement can be queried using CONFigure?. Use the :CONFigure PFail command to set Pass/Fail as the active measurement.

Related Command: MEASure:PFail?
:CONFigure PFail
READ:PFail?

:FETCh:RF:ACPR?

Title: Fetch Adjacent Channel Power Ratio

Description: Returns the most recent adjacent channel power ratio measurement results.

Data is returned as 11 comma-delimited values: The Channel Power in dBm, relative adjacent channel 1 power level, absolute adjacent channel 1 power level, relative adjacent channel 2 power level, absolute adjacent channel 2 power level, relative adjacent channel 3 power level, absolute adjacent channel 3 power level, relative adjacent channel 4 power level, absolute adjacent channel 4 power level, relative adjacent channel 5 power level, absolute adjacent channel 5 power level. The relative adjacent channel power level is in dB and the absolute adjacent channel power level is in dBm. “-” is returned for each data that is not valid at that instance.

Related Command: :CONFigure:RF ACPR
:MEASure:RF:ACPR?
:READ:RF:ACPR?

Front Panel

Access: Measurements, RF Measurements, ACPR

:FETCh:RF:PVTime?

Title: Fetch Power vs. Time

Description: Returns the most recent WiMAX 802.16-2004 OFDM signal over approximately one frame time domain measurement results.

Data is returned as 4 comma-delimited values: The Channel Power in dBm, Preamble power in dBm, downlink burst power of data bursts in dBm, and uplink burst power of data bursts in dBm. "--" is returned for each data that is not valid at that instance.

:FETCh:RF:SPECTrum?

Title: Fetch RF Spectrum

Description: Returns the most recent RF Spectrum measurement results.

Data is returned as 2 comma-delimited values: Channel Power(RSSI) in dBm and Occupied bandwidth measurement in MHz. "--" is returned for each data that is not valid at that instance.

Related Command: :CONFIgure:RF SPECTrum
:MEASure:RF:SPECTrum?
:READ:RF:SPECTrum?

12-5 :FORMat Subsystem

This subsystem contains commands that determine the formatting of numeric data when it is transferred.

The format setting affects data in specific commands only. If a command is affected, it is noted in the command description.

:FORMat[:READings][:DATA] ASCii|INTeger,32|REAL,32

:FORMat[:READings][:DATA]?

Title: Numeric Data Format

Description: This command specifies the format in which data is returned in certain commands.

ASCii format returns the data in comma-separated ASCII format. The units are the current instrument units. This format requires many more bytes so it is the slowest format. INTeger 32 values are signed 32-bit integers in little-endian byte order. This format returns the data in 4-byte blocks. REAL,32 values are 32-bit floating point numbers conforming to the IEEE 754 standard in little-endian byte order. This format returns the data in 4-byte binary format. The units are the current instrument units.

Both INTeger,32 and REAL,32 formats return a definite block length. Each transfer begins with an ASCII header such as #42204. The first digit represents the number of following digits in the header (in this example, 4). The remainder of the header indicates the number of bytes that follow the header (in this example, 2204). You then divide the number of following bytes by the number of bytes in the data format you've chosen (4 for both INTeger,32 and REAL,32) to get the number of data points (in this example, 551).

Parameter: ASCii|INTeger,32|REAL,32

Parameter Type: <char>

Default Value: ASCii

Related Command: :TRACe[:DATA]

12-6 :INITiate Subsystem

This subsystem controls the triggering of measurements.

:INITiate:CONTInuous OFF|ON|0|1

:INITiate:CONTInuous?

Title: Continuous/Single Sweep

Description: Specifies whether the sweep/measurement is triggered continuously. If the value is set to ON or 1, another sweep/measurement is triggered as soon as the current one completes. If continuous is set to OFF or 0, the instrument enters the “idle” state and waits for the :INITiate[:IMMEDIATE] command or for :INITiate:CONTInuous ON. The default value is ON. That is, sending :INIT:CONT is equivalent to sending :INIT:CONT ON. The query version of the command returns a 1 if the instrument is continuously sweeping/measuring and returns a 0 if the instrument is in single sweep/measurement mode. Note that rapid toggling between ON and OFF is not allowed. The instrument must be allowed to make a full sweep before toggling can be done.

Parameter: OFF|ON|0|1

Parameter Type: <boolean>

Default Value: ON

Related Command: :INITiate[:IMMEDIATE]
:INITiate:HOLD

Front Panel

Access: Shift-3 (Sweep), Sweep

:INITiate[:IMMEDIATE]

Title: Trigger Sweep/Measurement

Description: Initiates a sweep/measurement. If :INITiate:CONTInuous is set to ON, this command is ignored. Use this command in combination with :STATus:OPERation? to synchronize the capture of one complete set of data. When this command is sent, the “sweep complete” bit of :STATus:OPERation? is set to 0, indicating that the measurement has not completed. The data collection is then triggered. The controlling program can poll :STATus:OPERation? to determine the status. When the “sweep complete” bit is set to 1, data is ready to be retrieved.

Related Command: :INITiate:CONTInuous
:STATus:OPERation?

Front Panel

Access: Shift-3 (Sweep), Trigger Sweep

12-7 :MEASure Subsystem

These commands take the instrument from its current state, enable the specified measurement and put the instrument into single sweep mode. They correct any parameters that are invalid given the new measurement state such that a valid measurement can take place. Other settings may be changed; see the documentation of CONFigure for each measurement. They then initiate the measurement. When the measurement is complete, they return the result.

To make a measurement with settings other than the “default” measurement settings applied by CONFigure, do the following:

- Send the appropriate CONFigure command to set the desired measurement.
- Modify the settings as required.
- Send the appropriate READ command to measure and return the result.

To get the current measurement data, use the appropriate FETCh command.

:MEASure:DEMod:CONStln?

Title: Measure Constellation

Description: Sets the active measurement to Constellation, sets the default measurement parameters, triggers a new measurement, and returns the EVM (rms), EVM (pk), RCE (rms), RCE (pk), Carrier Frequency, Freq Error, Freq Error, and the Base Station ID. It is a combination of the commands :CONFigure:DEMod CONStln and :READ:DEMod:CONStln? To make a Demodulated Constellation measurement with settings other than the default values, send:

```
:CONFigure:DEMod CONStln
Commands to set desired settings
:READ:DEMod:CONStln?
```

Data is returned as 8 comma-delimited values: EVM (rms) in %, EVM (pk) in %, RCE (rms) in dB, RCE (pk) in dB, Freq Error in MHz, CINR in dB, Base Station ID, and the Sector ID.

Related Command: :READ:DEMod:CONStln?
:CONFigure:DEMod CONStln

:MEASure:DEMod:EVSCarrier?

Title: Measure EVM vs. Sub Carrier

Description: Sets the active measurement to EVM vs. Sub Carrier, sets the default measurement parameters, triggers a new measurement, and returns the EVM (rms), EVM (pk), RCE (rms), RCE (pk), Carrier Frequency, Freq Error, Freq Error, and the Base Station ID. It is a combination of the commands :CONFigure:DEMod EVSCarrier and :READ:DEMod:EVSCarrier? To make an EVM vs. Symbol measurement with settings other than the default values, send:

```
:CONFigure:DEMod EVSCarrier
Commands to set the desired settings
:READ:DEMod:EVSCarrier?
```

Data is returned as 8 comma-delimited values: EVM (rms) in %, EVM (pk) in %, RCE (rms) in dB, RCE (pk) in dB, Carrier Frequency in MHz, Freq Error in MHz, Freq Error in ppm, and the Base Station ID.

Related Command: :READ:DEMod:EVSCarrier?
:CONFigure:DEMod EVSCarrier

:MEASure:DEMod:EVSYmbol?

Title: Measure EVM vs. Symbol

Description: Sets the active measurement to EVM vs. Symbol, sets the default measurement parameters, triggers a new measurement, and returns the EVM (rms), EVM (pk), RCE (rms), RCE (pk), Carrier Frequency, Freq Error, Freq Error, and the Base Station ID. It is a combination of the commands :CONFigure:DEMod EVSYmbol and :READ:DEMod:EVSYmbol? To make an EVM vs. Symbol measurement with settings other than the default values, send:

:CONFigure:DEMod EVSYmbol
Commands to set the desired settings
:READ:DEMod:EVSYmbol?

Data is returned as 8 comma-delimited values: EVM (rms) in %, EVM (pk) in %, RCE (rms) in dB, RCE (pk) in dB, Carrier Frequency in MHz, Freq Error in MHz, Freq Error in ppm, and the Base Station ID.

Related Command: :READ:DEMod:EVSYmbol?
:CONFigure:DEMod EVSYmbol

:MEASure:DEMod:SFLatness?

Title: Measure Spectral Flatness

Description: Sets the active measurement to Spectral Flatness, sets the default measurement parameters, triggers a new measurement, and returns the absolute delta of the power between adjacent sub carriers in dB. It is a combination of the commands :CONFigure:DEMod SFLatness and :READ:DEMod:SFLatness? To make a Spectral Flatness measurement with settings other than the default values, send:

:CONFigure:DEMod SFLatness
Commands to set desired settings
:READ:DEMod:SFLatness?

Related Command: :READ:DEMod:SFLatness?
:CONFigure:DEMod SFLatness

:MEASure:PFail?

Title: Measure PASS/FAIL

Description: Sets the active measurement to PASS/FAIL, sets the default measurement parameters, triggers a new measurement and returns the PASS/FAIL results. It is a combination of the commands :CONFigure PFail and :READ:PFail? To make a PASS/FAIL measurement with settings other than the default values, send:

```
:CONFigure PFail
Commands to set desired settings
:READ:PFail?
```

Related Command: :CONFigure PFail
:READ:PFail?
:FETCh:PFail?

Front Panel

Access: Measurements, Pass/Faile Mode

:MEASure:RF:ACPR?

Title: Measure Adjacent Channel Power Ratio

Description: Sets the active measurement to ACPR, sets the default measurement parameters, triggers a new measurement, and returns the power levels for each channel (both absolute and relative). It is a combination of the commands :CONFigure:RF ACPR and :READ:RF:SPECTrum? To make an RF ACPR measurement with settings other than the default values, send:

```
:CONFigure:RF ACPR
Commands to set desired settings
:READ:RF:ACPR?
```

Data is returned as 11 comma-delimited values: The Channel Power in dBm, relative adjacent channel 1 power level, absolute adjacent channel 1 power level, relative adjacent channel 2 power level, absolute adjacent channel 2 power level, relative adjacent channel 3 power level, absolute adjacent channel 3 power level, relative adjacent channel 4 power level, absolute adjacent channel 4 power level, relative adjacent channel 5 power level, absolute adjacent channel 5 power level. The relative adjacent channel power level is in dB and the absolute adjacent channel power level is in dBm.

Related Command: :READ:RF:ACPR?
:CONFigure:RF ACPR
:FETCh:RF:ACPR?

Front Panel

Access: Measurements, RF Measurements, ACPR

:MEASure:RF:PVTime?

Title: Measure Power vs. Time

Description: Sets the active measurement to Power vs. Time, sets the default measurement parameters, triggers a new measurement and returns the Channel Power, Preamble power, burst power of data bursts, and the Crest Factor. It is a combination of the commands :CONFigure:RF PVTime and :READ:RF:PVTime? To make an RF ACPR measurement with settings other than the default values, send:

:CONFigure:RF PVTime

Commands to set desired settings

:READ:RF:PVTime?

Data is returned as 4 comma-delimited values: The Channel Power in dBm, Preamble power in dBm, burst power of data bursts in dBm, and the Crest Factor in dB.

Related Command: :READ:RF:PVTime?
:CONFigure:RF PVTime

:MEASure:RF:SPECTrum?

Title: Measure RF Spectrum

Description: Sets the active measurement to Spectrum, sets the default measurement parameters, triggers a new measurement and returns the Channel Power (RSSI) and Occupied bandwidth measurement. It is a combination of the commands :CONFigure:RF SPECTrum and :READ:RF:SPECTrum? To make an RF Spectrum measurement with settings other than the default values, send:

:CONFigure:RF SPECTrum

Commands to set desired settings

:READ:RF:SPECTrum?

Data is returned as 2 comma-delimited values: Channel Power (RSSI) in dBm Occupied bandwidth measurement in MHz.

Related Command: :CONFigure:RF SPECTrum
:READ:RF:SPECTrum?
:FETCh:RF:SPECTrum?

Front Panel

Access: Measurements, RF Measurements, Channel Spectrum

12-8 :MMEMory Subsystem

The Mass Memory subsystem contains functions that provide access to the instrument's setup and data storage.

:MMEMory:DELeTe <filename>

Title: Delete Setup/Measurement

Description: Removes a file specified by <filename> from the current mass storage device. <filename> should be enclosed in either single quotes (') or double quotes (") and it must include the file extension. Use the command MMEMory:MSIS to set the current file location.

Parameter: <filename>

Related Command: :MMEMory:STORe:STATe
:MMEMory:STORe:TRACe
:MMEMory:MSIS INTernal|USB

Front Panel

Access: Shift-7 (File), Delete, Delete Selected File

:MMEMory:LOAD:STATe <integer>,<filename>

Title: Recall Setup

Description: Recalls a previously stored instrument setup in the current save location. The setup file to be loaded is specified by <filename>. <filename> should be enclosed in either single quotes (') or double quotes (") and should contain a file extension ".stp". Use the command MMEMory:MSIS to set the current save location. The <integer> parameter is not currently used, but it must be sent. Send a 1.

Parameter: <integer>, <filename>

Related Command: :MMEMory:STORe:STATe
:MMEMory:MSIS INTernal|USB

Front Panel

Access: Shift-7 (File), Recall

:MMEMory:LOAD:TRACe <integer>,<filename>

Title: Recall Measurement

Description: The instrument must be in the mode of the saved trace in order to recall that trace. Use :INSTRument:SELeCt or :INSTRument:NSELeCt to set the mode. Recalls a previously stored measurement trace from the current save location. The saved measurement trace to be loaded is specified by <filename>. <filename> should be enclosed in either single quotes (') or double quotes (") and should contain a file extension. Note that the trace specified by <filename> should be available at the current save location. Use the command MMEMory:MSIS to set the current save location. The <integer> parameter is not currently used, but it must be sent. Send a 1.

File name extensions:

“.edg” for GSM
 “.spa” for SPA
 “.wcd” for WCDMA
 “.wmx” for WiMAX
 “.wmx” for Mobile WiMAX
 “.vna” for Cable & Antenna
 “.cdma” for CDMA
 “.tds” for TDSCDMA
 “.evdo” for EVDO
 “.ia” for Interference Analysis
 “.cs” for Channel Scanner
 “.pm” for Power Meter
 “.tm” for Transmission Measurement
 “.lte” for LTE Analyzer

Note: Extensions not available for T1 and Hi_PM.

Parameter: <integer>, <filename>

Example: To recall trace with file name “trace”:

```
:MMEMory:LOAD:TRACe 1, "trace.spa"
```

Related Command: :MMEMory:STORe:TRACe
 :MMEMory:STORe:TRACe
 :MMEMory:MSIS INTernal|USB

Front Panel

Access: Shift-7 (File), Recall Measurement

:MMEMory:STORe:STATe <integer>, <filename>

Title: Save Setup

Description: Stores the current setup into the file specified by <filename>. <filename> should be enclosed in either single quotes (') or double quotes (") and should not contain a file extension. Use the command MMEMory:MSIS to set the current save location. The <integer> parameter is not currently used, but it must be sent. Send a value of 0.

Parameter: <integer>, <filename>

Related Command: :MMEMory:LOAD:STATe
 :MMEMory:MSIS INTernal|USB

Front Panel

Access: Shift-7 (File)

:MMEMory:STORe:TRACe <integer>,<filename>

Title: Save Measurement

Description: Stores the trace into the file specified by <filename>. <filename> should be enclosed in either single quotes (' ') or double quotes (" ") and should not contain a file extension. Use the command MMEMory:MSIS to set the current save location. The <integer> parameter is not currently used, but it must be sent. Send a 0. Note that existing files of the same name will not be overwritten.

Parameter: <integer>, <filename>

Example: To save the trace into the file name "trace":

```
:MMEMory:STORe:TRACe 0,"trace"
```

Related Command: :MMEMory:LOAD:TRACe
:MMEMory:MSIS INTernal|USB

Front Panel

Access: Shift-7 (File), Save

12-9 :READ Subsystem

This set of commands combines the ABORT, INITiate and FETCh commands. It aborts any current triggering sequence and sets the trigger state to idle. It then initiates a new active measurement (i.e. begins the collection of new data). When the measurement is complete, it returns the result. These commands will not switch to another measurement.

To get the current measurement data, use the FETCh command.

:READ:DEMod:CONStln?

Title: Read Constellation

Description: Triggers a new Constellation measurement and returns the results: EVM (rms), EVM (pk), RCE (rms), RCE (pk), Carrier Frequency, Freq Error, Freq Error, and the Base Station ID. The Constellation measurement must be the active measurement (specified by :CONFigure:DEMod CONStln). The current measurement can be queried using the command :CONFigure?

Data is returned as 8 comma-delimited values: EVM (rms) in %, EVM (pk) in %, RCE (rms) in dB, RCE (pk) in dB, Carrier Frequency in MHz, Freq Error in MHz, Freq Error in ppm, and the Base Station ID.

Related Command: :FETCh:DEMod:CONStln?
:CONFigure:DEMod CONStln

:READ:DEMod:EVSCarrier?

Title: Read EVM vs. Sub Carrier

Description: Triggers a new EVM vs. Sub Carrier measurement and returns the results: EVM (rms), EVM (pk), RCE (rms), RCE (pk), Carrier Frequency, Freq Error, Freq Error, and the Base Station ID. The EVM vs. Sub Carrier measurement must be the active measurement (specified by :CONFigure:DEMod EVSCarrier). The current measurement can be queried using the command :CONFigure?

Data is returned as 8 comma-delimited values: EVM (rms) in %, EVM (pk) in %, RCE (rms) in dB, RCE (pk) in dB, Carrier Frequency in MHz, Freq Error in MHz, Freq Error in ppm, and the Base Station ID.

Related Command: :FETCh:DEMod:EVSCarrier?
:CONFigure:DEMod EVSCarrier

:READ:DEMod:EVSYmbol?

Title: Read EVM vs. Symbol

Description: Triggers a new EVM vs. Symbol measurement and returns the results: EVM (rms), EVM (pk), RCE (rms), RCE (pk), Carrier Frequency, Freq Error, Freq Error, and the Base Station ID. The EVM vs. Symbol measurement must be the active measurement (specified by :CONFigure:DEMod EVSYmbol). The current measurement can be queried using the command :CONFigure?

Data is returned as 8 comma-delimited values: EVM (rms) in %, EVM (pk) in %, RCE (rms) in dB, RCE (pk) in dB, Carrier Frequency in MHz, Freq Error in MHz, Freq Error in ppm, and the Base Station ID.

Related Command: :FETCh:DEMod:EVSymbol?
:CONFigure:DEMod EVSymbol

:READ:DEMod:SFlatness?

Title: Read Spectral Flatness

Description: Triggers a new Spectral Flatness measurement and returns the absolute delta of the power between adjacent sub carriers in dB. The Spectral Flatness measurement must be the active measurement (specified by :CONFigure:DEMod SFlatness). The current measurement can be queried using the command :CONFigure?

Related Command: :FETCh:DEMod:SFlatness?
:CONFigure:DEMod SFlatness

:READ:PFail?

Title: Read PASS/FAIL

Description: Triggers a new PASS/FAIL measurement and returns the results. It is a combination of the commands :ABORT; :INITiate; :FETCh:PFail? The PASS/FAIL measurement must be active. The current measurement can be queried using :CONFigure?

Related Command: :FETCh:PFail?
:CONFigure PFail
:MEASure:PFail?

Front Panel

Access: Measurements, Pass/Fail Mode

:READ:RF:ACPR?

Title: Read Adjacent Channel Power Ratio

Description: Triggers a new Adjacent Channel Power Ratio measurement and returns the results: Power levels for each channel (both absolute and relative). It is a combination of the commands :ABORT; :INITiate; :FETCh:RF:ACPR? The ACPR measurement must be the active measurement (specified by :CONFigure:RF ACPR). The current measurement can be queried using :CONFigure?

Data is returned as 11 comma-delimited values: The Channel Power in dBm, relative adjacent channel 1 power level, absolute adjacent channel 1 power level, relative adjacent channel 2 power level, absolute adjacent channel 2 power level, relative adjacent channel 3 power level, absolute adjacent channel 3 power level, relative adjacent channel 4 power level, absolute adjacent channel 4 power level, relative adjacent channel 5 power level, absolute adjacent channel 5 power level. The relative adjacent channel power level is in dB and the absolute adjacent channel power level is in dBm.

Related Command: :FETCh:RF:ACPR?
:CONFigure:RF ACPR
:MEASure:RF:ACPR?

:READ:RF:PVTime?

Title: Read Power vs. Time

Description: Triggers a new Power vs. Time measurement and returns the results: Channel Power, Preamble power, burst power of data bursts, and the Crest Factor. It is a combination of the commands :ABORT; :INITiate; :FETCh:RF:PVTime? The Power vs. Time measurement must be the active measurement (specified by :CONFigure:RF PVTime). The current measurement can be queried using :CONFigure?

Data is returned as 4 comma-delimited values: The Channel Power in dBm, Preamble power in dBm, burst power of data bursts in dBm, and the Crest Factor in dB.

Related Command: :FETCh:RF:PVTime?
:CONFigure:RF PVTime

:READ:RF:SPECTrum?

Title: Read RF Spectrum

Description: Triggers a new RF Spectrum measurement and returns the results: Channel Power (RSSI) and Occupied bandwidth measurement. It is a combination of the commands :ABORT; :INITiate; :FETCh:RF:SPECTrum? The Spectrum measurement must be the active measurement (specified by :CONFigure:RF SPECTrum). The current measurement can be queried using :CONFigure?

Data is returned as 2 comma-delimited values: Channel Power(RSSI) in dBm and Occupied bandwidth measurement in MHz.

Related Command: :FETCh:RF:SPECTrum?
:CONFigure:RF SPECTrum
:MEASure:RF:SPECTrum?

12-10 :TRACe Subsystem

This subsystem contains commands related to the transfer of trace data to and from the instrument.

:TRACe:PREamble? <trace type>

Title: Trace Header Transfer

Description: Returns trace header information for the specified trace. The <trace type> must be one of the following:
SPECTrum | PVTTime | ACPR | CONSTln | SFLatness | EVSCarrier | EVSYmbol

Data can be transferred to and from the 7 available display trace types. Use the commands in the MMEMory subsystem to store and recall traces from the instrument memory. The response begins with an ASCII header. The header specifies the number of following bytes. It looks like #AX, where A is the number of digits in X and X is the number of bytes that follow the header. Parameters are returned in comma-delimited ASCII format. Each parameter is returned as "NAME=VALUE[UNITS]," Valid parameter names are shown in Chapter 2.

Parameter: <trace type>

Related Command: :TRACe:DATA?

:TRACe[:DATA]? <trace type>

Title: Trace Data Transfer

Description: This command transfers trace data from the instrument to the controller. The <trace type> must be one of the following:
SPECTrum | PVTTime | CONSTln | SFLatness | EVSCarrier | EVSYmbol.

The format of the block data in the query form is specified by :FORMat:DATA. The block data in the command form is always sent in ASCII format. The response begins with an ASCII header that specifies the number of data bytes. It looks like #AX, where A is the number of digits in X and X is the number of bytes that follow the header. Each data point is separated by a comma delimiter. Trace setup information can be acquired using :TRACe[:DATA]:PREamble?

Use the commands in the MMEMory subsystem to store and recall traces from the instrument memory. Except for CONSTln there is only one value per data point. If max hold is set to ON for SPECTrum and EVM vs. Sub Carrier then the max hold value is returned. For CONSTln, each data point is represented by 3 values 4 bytes each: IData (no units), QData (no units), and the constellation type (no units). For SPECTrum and PVTime unit is in dBm. For Spectral Flatness unit is in dB. For EVM vs Sub Carrier and EVM vs Symbol unit is in percent. Note that the instrument must be set in the selected view. Use the CONFigure command to set the unit to the selected view.

Parameter: <trace type>

Related Command: :FORMat [:DATA]
:TRACe [:DATA]:PREamble?

12-11 [:SENSE] Subsystem

The commands in this subsystem relate to device-specific parameters, not signal-oriented parameters.

[:SENSE]:BANDwidth|BWIDth[:RESolution] <index>

[:SENSE]:BANDwidth|BWIDth[:RESolution]?

Title: Resolution Bandwidth

Description: Sets the resolution bandwidth. The <index> argument is a 1-based index of the position of the desired bandwidth in the instrument's current bandwidth list. The list can be displayed on the instrument by choosing the "BW" submenu button in the "Setup" menu. For example, if the desired bandwidth is the 3rd item on the list, then the value of the <index> argument would be 3.

The query form of this command will return the index of the currently selected bandwidth on the list. The Default is the 1st index in the bandwidth list.

Parameter: <index>

Default Value: The default bandwidth is 5 MHz which is the 1st index in the bandwidth list.

Front Panel

Access: Setup, BW

[:SENSE]:DEMod:CONStln:REFPoints[:STATe] OFF|ON|0|1

[:SENSE]:DEMod:CONStln:REFPoints[:STATe]?

Title: Constellation Reference Points

Required Option: 47

Description: Sets the display of the reference points for the various constellations on/off.

Parameter: OFF|ON|0|1

Parameter Type: <boolean>

Default Value: ON

Front Panel

Access: Measurements, Demodulator, Constellation, Reference Points

[:SENSE]:FREQUENCY:CENTER <freq>

[:SENSE]:FREQUENCY:CENTER?

Title: Center Frequency

Description: Sets the center frequency. Note that changing the value of the center frequency will change the value of the coupled parameters Start Frequency and Stop Frequency. It may also change the value of the span.

Parameter: <freq>

Default Value: 2.5 GHz

Default Unit: Hz

Range: 0 Hz to 7.1 GHz

Front Panel

Access: Freq, Center Freq

[:SENSE]:FREQUENCY:SIGSTANDARD:CHANNEL <number>

[:SENSE]:FREQUENCY:SIGSTANDARD:CHANNEL?

Title: Channel Selection

Description: Sets the channel number for the selected signal standard.

Parameter: <number>

Front Panel

Access: Freq, Channel

[:SENSE]:FREQUENCY:SIGSTANDARD:NAME <string>

[:SENSE]:FREQUENCY:SIGSTANDARD:NAME?

Title: Signal Standard

Description: Selects the desired signal standard from the list. The <string> argument is the name of the desired signal standard as displayed in the instrument's current signal standard list. The list can be displayed on the instrument by choosing the Signal Standard submenu button in the Freq menu. The list can also be downloaded remotely and viewed using Anritsu Master Software Tools. For example, if the desired Signal Standard is P-GSM 900 - Uplink, then the value of the <string> argument would be "P-GSM 900 - Uplink".

The query form of this command will return the name of the currently selected Signal Standard on the list.

Parameter: <string>

Front Panel

Access: Freq, Signal Standard

[:SENSE]:PFail <test set>

[:SENSE]:PFail?

Title: PASS/FAIL Test Selection

Description: Selects the active test set to be used in subsequent PASS/FAIL measurements. The <test set> value must correspond to a test set that is defined in the test set list. To view the list on the instrument, go into the "Measurement" menu, press the "Pass/Fail Mode" key, and then press the "Select Pass/Fail Test" submenu. Alternatively, the list can be retrieved remotely and viewed using the Anritsu Master Software Tools. The <test set> argument is a 1-based index of the position of the desired Pass/Fail test set in the instrument's current Pass/Fail test set list. For example, if the desired Pass/Fail test is the 3rd item on the list, then the value of the <test set> argument would be 3.

When using the query form of the command, the return value is the currently selected test set number. If there is not a valid test set selected, the return value is "-1" (negative 1).

Parameter: <test set>

Related Command: :CONFigure PFail

Front Panel

Access: Measurements, Pass/Fail Mode, Select Pass/Fail Test

[:SENSE]:POWer[:RF]:RANGe:AUTO OFF|ON|0|1

[:SENSE]:POWer[:RF]:RANGe:AUTO?

Title: Automatic Amplitude Range

Description: Sets the automatic amplitude range. Setting the value to ON or 1 will result in the amplitude range being coupled to the detected input signal level. Setting the value to OFF or 0 will result in the input attenuation being un-coupled from the input signal level. That is, changing the input signal level will not change the amplitude range. When this command is issued, the amplitude range itself will not change. The default value is ON. That is, sending :SENS:POW:RANG:AUTO is equivalent to sending :SENS:POW:RANG:AUTO ON.

Parameter: OFF|ON|0|1

Parameter Type: <boolean>

Default Value: ON

Related Command: [:SENSE]:POWer[:RF]:RANGe

Front Panel

Access: Amplitude, Auto Range

[:SENSe]:POWer[:RF]:RANGe[:IMMediate]

Title: Amplitude Range

Description: Re-calculates amplitude range. Note that issuing this command will set the automatic dynamic range OFF.

Related Command: [:SENSe]:POWer[:RF]:RANGe:AUTO

Front Panel

Access: Amplitude, Adjust Range

[:SENSe]:RF:SPECTrum:SPAN 5|10|20|30**[:SENSe]:RF:SPECTrum:SPAN?**

Title: Spectrum View Span

Description: Sets the span for the Spectrum view. Setting the value to 5 will set the span for the Spectrum view to 5 MHz. Setting the value to 10 will set the span for the Spectrum view to 10 MHz. Setting the value to 20 will set the span for the Spectrum view to 20MHz. Setting the value to 30 will set the span for the Spectrum view to 30MHz.

Parameter: 5|10|20|30

Default Value: 10 MHz

Default Unit: MHz

Front Panel

Access: Measurements, RF Measurements, Spectrum, Span

Chapter 13 — LTE Commands

13-1 :ABORt Subsystem

The abort subsystem includes commands that allow the user to stop current measurement activities on the instrument.

:ABORt

Title: Abort

Description: Restarts the current sweep and/or measurement. If INITiate:CONTinuous is OFF (i.e. the instrument is in single sweep mode), send the command :INITiate[:IMMEDIATE] to trigger the next sweep. If :INITiate:CONTinuous is ON (i.e. the instrument is in continuous sweep mode), a new sweep will start immediately.

Parameter: NA

13-2 :CALCulate Subsystem

The commands in this subsystem process data that has been collected via the SENSE subsystem.

:CALCulate:MARKer:AOff

Title: Turn All Markers Off

Description: Turns off all markers in Channel Spectrum.

Front Panel

Access: Marker, Markers Off

:CALCulate:MARKer1:DELTA:X <x1 parameter>

:CALCulate:MARKer1:DELTA:X?

Title: Delta Marker 1 X Value

Description: Sets/Queries the relative location of the delta marker from the reference marker on the x-axis.

Note: The query value might not always match the set value since the instrument will round the set value based on the display pixel resolution.

The x1 parameter is used to set the delta position.

For example, :CALC:MARK1:DELT:X 2 MHz will set the delta value to 2 MHz.

Parameter: <x1 parameter>

Default Unit: Hz

Related Command: :CALCulate:MARKer1:X

Front Panel

Access: Marker, Marker Select (M1), Marker State (Delta), (Use arrow keys or rotary knob.)

:CALCulate:MARKer1:DELTA:Y?

Title: Delta Marker 1 Read Y Value

Description: Reads the current absolute Y value for delta marker 1.

Default Unit: dBm

:CALCulate:MARKer1:MAXimum

Title: Set Marker 1 to Peak

Description: Moves marker 1 to peak position on data trace.

Parameter: NA

Front Panel

Access: Marker, Marker Select (M1), Peak Search

:CALCulate:MARKer1:STATE OFF|ON|DELta
:CALCulate:MARKer1:STATE?

Title: Set Marker 1 State

Description: Sets marker 1 on/off or delta.

Parameter: OFF|ON|DELta

Parameter Type: <char>

Default Value: OFF

Front Panel

Access: Marker, Marker Select (M1), Marker State

:CALCulate:MARKer1:X <x-parameter>
:CALCulate:MARKer1:X?

Title: Set Marker 1 Value

Description: Sets/Queries the location of marker 1 on the x-axis at the specified location.

Parameter: <x-parameter>

Default Unit: Hz

Front Panel

Access: Marker, Marker Select [1/2/3/4/5/6] (use arrow keys or rotary knob)

:CALCulate:MARKer1:Y?

Title: Marker 1 Read Y Value

Description: Reads the current Y value for marker 1.

Default Unit: dBm

:CALCulate:MARKer2:DELta:X <x1 parameter>
:CALCulate:MARKer2:DELta:X?

Title: Delta Marker X Value

Description: Sets/Queries the relative location of the delta marker from the reference marker on the x-axis.

Note: The query value might not always match the set value since the instrument will round the set value based on the display pixel resolution.

The x1 parameter is used to set the delta position.

For example, :CALC:MARK2:DELTA:X 2 MHz will set the delta value to 2 MHz.

Parameter: <x1 parameter>

Default Unit: Hz

Related Command: :CALCulate:MARKer2:X

Front Panel

Access: Marker, Marker Select (M2), Marker State (Delta), (Use arrow keys or rotary knob.)

:CALCulate:MARKer2:DELTA:Y?

Title: Delta Marker 2 Read Y Value

Description: Reads the current absolute Y value for delta marker 2.

Default Unit: dBm

:CALCulate:MARKer2:MAXimum

Title: Set Marker 2 to Peak

Description: Moves marker 2 to peak position on data trace.

Parameter: NA

Front Panel

Access: Marker, Marker Select (M2), Peak Search

:CALCulate:MARKer2:STATE OFF|ON|DELTA

:CALCulate:MARKer2:STATE?

Title: Set Marker 2 State

Description: Sets marker 2 on/off or delta.

Parameter: OFF|ON|Delta

Parameter Type: <char>

Default Value: OFF

Front Panel

Access: Marker, Marker Select (M2), Marker State

:CALCulate:MARKer2:X <x-parameter>

:CALCulate:MARKer2:X?

Title: Set Marker 2 Value

Description: Sets/Queries the location of marker 2 on the x-axis at the specified location.

Parameter: <x-parameter>

Default Unit: Hz

Front Panel

Access: Marker, Marker Select (M2), Peak Search

:CALCulate:MARKer2:Y?

Title: Marker2 Read Y Value

Description: Reads the current Y value for marker 2.

Default Unit: dBm

13-3 :CONFigure Subsystem

This set of commands prepares the instrument for the selected measurement. It disables any currently-enabled measurements and activates the specified measurement. It sets the instrument to single sweep mode, waiting for an :INITiate command. It will not initiate the taking of a measurement.

Current instrument settings may be changed to default values. These changes are identified with their respective measurement commands.

:CONFigure?

Title: Configure Query

Description: :CONFigure? query returns the name of the measurement previously set up using a CONFigure command or a MEASure? query. The list below shows the possible return values.

CAGG
SUMM
RF,SPEC
RF,ACLR
RF,SEM
RF,SUMM
DEM,CONS
DEM,CCPG
DEM,CCPT
DEM,SUMM
PF
OTA
OTA,OTAS

:CONFigure:DEMod**SUMMARY | CONSTln | CCPGraph | CCPTable | TIMEalign**

Title: Select the Modulation Measurement

Description: Sets measurement to one of the Modulation screens. This can be one of:

SUMMARY: Modulation Summary view

CONSTln: Modulation Constellation diagram

CCPGraph: Control Channel Power - Bar-graph view

CCPTable: Control Channel Power - Table view

TIMEalign: Tx Time Alignment

It disables any other active measurements. None of the instrument parameters are changed by the execution of this command. Sets the instrument to single sweep mode (:INITiate:CONTinuous OFF).

Measurement settings can be modified by using the [:SENSe] commands before initiating a measurement.

Parameter: SUMMARY | CONSTln | CCPGraph | CCPTable | TIMEalign

Parameter Type: <char>

Front Panel

Access: Measurements, Modulation, (Constellation, Control Channel Power, Tx Time Alignment, Modulation Summary). If Control Channel Power is selected, press Control Channel Power again, then press Display Mode to select Bar Graph or Table.

:CONFigure:OTA SCANner | TXTEst | MAPping | CAGGregation

Title: Configure Over-the-Air Measurement

Description: Sets the measurement to one of the Over-the-Air screens. This can be one of:

SCANner: Scanner measurement view

TXTEst: Tx Test measurement view

MAPping: Coverage Mapping measurement view

CAGGregation: Carrier Aggregation measurement view

Parameter: SCANner | TXTEst | MAPping | CAGGregation

Parameter Type: <char>

Front Panel

Access: Measurements, Over-the-Air, (Scanner, Tx Test, Mapping, Carrier Aggregation)

:CONFigure:RF SUMMArY | SPECTrum | ACLR | SEM

Title: Select RF Measurements

Description: This command configures RF measurements. It disables any other active measurements. None of the instrument parameters are changed by the execution of this command. Sets the instrument to single sweep mode (:INITiate:CONTinuous OFF). Measurement settings can be modified by using the [:SENSE] commands before initiating a measurement.

Set measurement to one of the RF measurement screens. This can be one of:

SUMMArY: RF measurement summary screen.

SPECTrum: RF Channel Spectrum measurement screen.

ACLR: ACLR measurement view.

SEM: Spectral Emission Mask measurement.

Parameter: SUMMArY | SPECTrum | ACLR | SEM

Front Panel

Access: Measurements, RF, (Channel Spectrum, ACLR, Spectral Emission Mask, RF Summary)

:CONFigure:OTA CAGGregation

Title: Set Measurement to Carrier Aggregation

Description: Sets the measurement to Carrier Aggregation.

Parameter: CAGGregation

Parameter Type: None

:CONFigure:OTA SCANner | TXTEst | MAPping | CAGGregation

Title: Configure Over-the-Air Measurement

Description: Sets the measurement to one of the Over-the-Air screens.

Parameter: SCANner | TXTEst | MAPping | CAGGregation

Parameter Type: <char>

:CONFigure SUMMary

Title: Set Measurement to LTE Summary

Description: Sets the measurement to LTE Summary. It disables any other active measurements. None of the instrument parameters are changed by the execution of this command. (:INITiate:CONTInuous OFF). Measurement settings can be modified by using the [:SENSE] commands before initiating a measurement.

Parameter: SUMMary

Parameter Type: <char>

Front Panel

Access: Measurements, LTE Summary

13-4 :DISPlay Subsystem

This subsystem provides commands that modify the display of data for the user. They do not modify the way in which data are returned to the controller.

:DISPlay:WINDow:TRACe:Y[:SCALE]:OFFSet <rel ampl>

:DISPlay:WINDow:TRACe:Y[:SCALE]:OFFSet?

Title: Power Offset

Description: Sets the power offset value for the y-axis.

Parameter: <rel ampl>

Default Value: 0 dB

Default Unit: dB

Range: -100 dB to +100 dB

Front Panel

Access: Amplitude, Power Offset

:DISPlay:WINDow:TRACe:Y[:SCALE]:PDIVision <rel ampl>

:DISPlay:WINDow:TRACe:Y[:SCALE]:PDIVision?

Title: Scale

Description: Sets the Scale/Division setting for the y-axis. This only affects the scale for the Channel Spectrum measurement.

Parameter: <rel ampl>

Default Value: 10 dB/div

Default Unit: dB

Range: 1 dB to 15 dB

Front Panel

Access: Amplitude, Scale

13-5 :FETCh Subsystem

This set of commands returns the most recent measurement data of the active measurement. They will not switch to another measurement.

To make a new measurement, use the INITiate command. To get new measurement data, use the READ or MEASure query commands.

:FETCh:DEMod:4x4:TIMEalign?

Title: Fetch Tx Time Alignment Data (4x4 MIMO configuration)

Description: Returns the most recent Time Alignment measurement numeric results. This command may not be supported if your instrument is loaded with older firmware, in which case you may upgrade to the current firmware version or use the :FETCh:DEMod:TIMEalign? command, instead. Refer to your instrument User Guide for instructions on updating firmware.

Data is returned as 14 comma-delimited values: EVM (rms) in %, EVM (pk) in %, Ref Signal (RS) Power in dBm, Sync Signal (SS) Power in dBm, Carrier Frequency in MHz, Freq Error in Hz, Freq Error in ppm, Cell ID, and Time Alignment Error (TAE) in nanoseconds for each of antenna pairs 1-2, 1-3, 1-4, 2-3, 2-4, and 3-4. "--" is returned for each data that is not valid at that instance.

Front Panel

Access: Measurements, Modulation, Tx Time Alignment

:FETCh:DEMod:CCPData?

Title: Fetch Control Power Data

Description: Returns the most recent Control Channel Power measurement numeric results.

Data is returned as 24 comma-delimited values: RS_POWER, PSS_POWER, SSS_POWER, BCH_POWER, CFI_POWER, RS_TOTAL_POWER, PSS_TOTAL_POWER, SSS_TOTAL_POWER, BCH_TOTAL_POWER, CFI_TOTAL_POWER, TOTAL_POWER, TOTAL_CHANNEL_POWER

Front Panel

Access: Measurements, Modulation, Control Channel Power

:FETCh:DEMod:CONStln?

Title: Fetch Constellation

Description: Returns the constellation measurement numeric results of the demodulated data symbol over one sub-frame measurement.

Data is returned as 10 comma-delimited values: EVM (rms) in %, EVM (pk) in %, Ref Signal (RS) Power in dBm, Sync Signal (SS) Power in dBm, Carrier Frequency in MHz, Freq Error in Hz, Freq Error in ppm, Cell ID, the number of measurements used in the frequency error average (if on), and OSTP (OFDM Symbol Transmit Power) in dBm. "--" is returned for each data that is not valid at that instance.

Front Panel

Access: Measurements, Modulation, Constellation

:FETCh:DEMod:PVRB?

Title: Fetch Power vs Resource Block Data

Description: Returns the PVRB measurement results of the demodulated data.

Data is returned as a string of comma-delimited values: Active RBs, Utilization in %, Channel Power in dBm, OSTP (OFDM Symbol Transmit Power) in dBm, EVM total in %, EVM (QPSK) in %, EVM (16-QAM) in %, EVM (64-QAM) in %, Cell ID.

If Option 886 is installed and activated on the instrument, a value for EVM (256-QAM) in % is returned at the end of the PVRB data string. "--" is returned if the LTE carrier does not use 256-QAM modulation scheme. This value does *not* immediately follow EVM (64-QAM) in order to maintain backward compatibility with instruments where Option 886 is not installed.

Front Panel

Access: Measurements, Modulation, Power vs Resource Block

:FETCh:DEMod:TIMEalign?

Title: Fetch Tx Time Alignment Data

Description: Returns the most recent Time Alignment measurement numeric results.

Data is returned as 9 comma-delimited values: EVM (rms) in %, EVM (pk) in %, Ref Signal (RS) Power in dBm, Sync Signal (SS) Power in dBm, Carrier Frequency in MHz, Freq Error in Hz, Freq Error in ppm, Cell ID, and Time Alignment Error (TAE) in nanoseconds. "--" is returned for each data that is not valid at that instance.

Front Panel

Access: Measurements, Modulation, Tx Time Alignment

:FETCh:OTA:C4AGGregation?

Title: Fetch OTA Carrier Aggregation (4x4 MIMO configuration)

Description: Returns the result of the most recent Carrier Aggregation measurement numeric results. This command may not be supported if your instrument is loaded with older firmware, in which case you may upgrade to the current firmware version or use the :FETCh:OTA:CAGGregation? command, instead. Refer to your instrument User Guide for instructions on updating firmware.

Data is returned as 70 comma delimited values. The values consist of 5 sets of Component Carrier (CC) data, with each set containing 14 fields (CP, tx1 antenna, tx2 antenna, tx3 antenna, tx4 antenna, RS Power, RS Delta Power, SS Power, EVM(rms), EVM(pk), Freq Error, Freq Error (ppm), TAE (nS), and Cell ID). The data is in sequential CC order. A field with "--" means the data was invalid. An inactive Component Carrier will show N/A for the entire set of data.

Front Panel

Access: Measurements, Over-the-Air, Carrier Aggregation

:FETCh:OTA:CAGGregation?

Title: Fetch OTA Carrier Aggregation

Description: Returns the result of the most recent Carrier Aggregation measurement numeric results. Data is returned as 60 comma delimited values.

The values consist of 5 sets of Component Carrier (CC) data with each set containing 12 fields (CP, tx1 antenna, tx2 antenna, RS Power, RS Delta Power, SS Power, EVM(rms), EVM(pk), Freq Error, Freq Error (ppm), TAE (nS), and Cell ID). The data is in sequential CC order. A field with "--" means the data was invalid. An inactive Component Carrier will show N/A for the entire set of data.

Front Panel

Access: Measurements, Over-the-Air, Carrier Aggregation

:FETCh:OTA:MAPping?

Title: Fetch OTA Coverage Mapping

Description: Returns the most recent Coverage Mapping measurement results.

Data is returned as six sets of comma-delimited values. Each set consists of: Cell ID, Group ID, Sector ID, S-SS Power, RSRP, RSRQ, and SINR.

Following the six sets of data is a final value for the Dominance. "--" is returned for each data that is not valid at that instance.

Front Panel

Access: Measurements, Over-the-Air, Mapping

: FETCh : OTA : SCANner?

Title: Fetch OTA Scanner

Description: Returns the most recent OTA Scanner measurement results.

Data is returned as six sets of comma-delimited values. Each set consists of: Cell ID, Group ID, Sector ID, S-SS Power, RSRP, RSRQ, and SINR.

Following the six sets of data is a final value for the Dominance. "--" is returned for each data that is not valid at that instance.

Front Panel

Access: Measurements, Over-the-Air, Scanner

: FETCh : OTA : TXTEst?

Title: Fetch OTA Tx Test

Description: Returns the most recent OTA Tx Text measurement results.

Data is returned as three sets of comma-delimited values. Each set consists of: Cell ID, Group ID, Sector ID, S-SS Power, RSRP, RSRQ, and SINR.

Following the three sets of data is an additional set of four numbers: Dominance, Antenna Count, Average Power, Delta Power. "--" is returned for each data that is not valid at that instance.

Front Panel

Access: Measurements, Over-the-Air, Tx Test

: FETCh : RF : ACLR?

Title: Fetch Adjacent Channel Leakage Ratio

Description: Returns the most recent adjacent channel leakage ratio measurement results. If the instrument is sweeping, it will not return until the sweep is complete. Refer to [“:READ:RF:ACLR?”](#) on page 13-27 for a description of the returned data.

Default Unit: dBm

Front Panel

Access: Measurements, RF, ACLR

: FETCh : RF : SEM?

Title: Fetch Spectral Emission Mask

Description: Returns Spectral Emission Mask measurement results (Pass or Fail).

Front Panel

Access: Measurements, RF, Spectral Emission Mask

:FETCh:RF:SPECTrum?

Title: Fetch RF Spectrum

Description: Returns the most recent RF Spectrum measurement results. Data is returned as 2 comma-delimited values: Channel Power in dBm and Occupied bandwidth measurement in MHz. "--" is returned for each data that is not valid at that instance.

Front Panel

Access: Measurements, RF, Channel Spectrum

:FETCh:SUMMArY?

Title: Fetch Summary

Description: Returns the values displayed in a Summary measurement view. If the current display is not a summary screen, the return value is 'N/A'. The return string is a comma-separated list of the values displayed on the screen, in the order they are listed from top to bottom. The list is preceded by the name of the summary view: "RF Summary," "Modulation Summary," or "LTE Summary".

RF Summary, Channel Power in dBm, Occupied BW in MHz, Lower Adjacent Channel Power 2 in dBm, Lower Adjacent Channel Power 1 in dBm, Upper Adjacent Channel Power 1 in dBm, Upper Adjacent Channel Power 2 in dBm, Spectral Emission Mask (Pass or Fail).

Modulation Summary, Ref Signal (RS) Power in dBm, Sync Signal (SS) Power in dBm, EVM (rms) in %, EVM (QPSK) in %, EVM (16-QAM) in %, EVM (64-QAM) in %, Freq Error in Hz, Freq Error in ppm, Cell ID, PBCH Power in dBm.

If Option 886 is activated on the instrument, a value for EVM (256-QAM) in % is returned at the end of the Modulation Summary data string. "--" is returned if the LTE carrier does not use 256-QAM modulation scheme. This value does *not* immediately follow EVM (64-QAM) in order to maintain backward compatibility with instruments where Option 886 is not installed.

LTE Summary, Freq Error in Hz, Occupied BW in MHz, Carrier Frequency in MHz, Channel Power in dBm, Ref Signal (RS) Power in dBm, Sync Signal (SS) Power in dBm, EVM (rms) in %, PBCH Power in dBm, PCFICH Power in dBm, Spectral Emission Mask (Pass or Fail).

When Option 886 is installed, 256-QAM EVM measurement results are included in the calculation of EVM (rms) percentage value.

Front Panel

Access: Measurements, RF, RF Summary

Measurements, Modulation, Modulation Summary

Measurements, LTE Summary

13-6 :FORMat Subsystem

This subsystem contains commands that determine the formatting of numeric data when it is transferred.

The format setting affects data in specific commands only. If a command is affected, it is noted in the command description.

:FORMat[:READings][:DATA] ASCii|INTeger,32|REAL,32

:FORMat[:READings][:DATA]?

Title: Numeric Data Format

Description: This command specifies the format in which data is returned in certain commands.

ASCii format returns the data in comma-separated ASCII format. The units are the current instrument units. This format requires many more bytes so it is the slowest format.

INTeger values are signed 32-bit integers in little-endian byte order. This format returns the data in 4-byte blocks.

REAL values are 32-bit floating point numbers conforming to the IEEE 754 standard in little-endian byte order. This format returns the data in 4-byte binary format. The units are the current instrument units.

Both INTeger and REAL formats return a definite block length. Each transfer begins with an ASCII header such as #42204. The first digit represents the number of following digits in the header (in this example, 4). The remainder of the header indicates the number of bytes that follow the header (in this example, 2204). You then divide the number of following bytes by the number of bytes in the data format you've chosen (4 for both INTeger and REAL) to get the number of data points (in this example, 551).

Parameter: ASCii|INTeger,32|REAL,32

Parameter Type: <char>

Default Value: ASCii

13-7 :INITiate Subsystem

This subsystem controls the triggering of measurements.

:INITiate:CONTInuous OFF|ON|0|1

:INITiate:CONTInuous?

Title: Continuous/Single Sweep

Description: Specifies whether the sweep/measurement is triggered continuously. If the value is set to ON or 1, another sweep/measurement is triggered as soon as the current one completes. If continuous is set to OFF or 0, the instrument enters the “idle” state and waits for the :INITiate[:IMMEDIATE] command or for :INITiate:CONTInuous ON. The default value is ON. That is, sending :INIT:CONT is equivalent to sending :INIT:CONT ON. The query version of the command returns a 1 if the instrument is continuously sweeping/measuring and returns a 0 if the instrument is in single sweep/measurement mode. Note that rapid toggling between ON and OFF is not allowed. The instrument must be allowed to make a full sweep before toggling can be done.

Parameter: OFF|ON|0|1

Parameter Type: <boolean>

Default Value: ON

Related Command: :INITiate[:IMMEDIATE]

Front Panel

Access: Shift-3 (Sweep), Sweep

:INITiate[:IMMEDIATE]

Title: Trigger Sweep/Measurement

Description: Initiates a sweep/measurement. If :INITiate:CONTInuous is set to ON, this command is ignored. Use this command in combination with :STATus:OPERation? to synchronize the capture of one complete set of data. When this command is sent, the “sweep complete” bit of :STATus:OPERation? is set to 0, indicating that the measurement has not completed.

The data collection is then triggered. The controlling program can poll :STATus:OPERation? to determine the status. When the “sweep complete” bit is set to 1, data is ready to be retrieved.

Related Command: :INITiate:CONTInuous
:STATus:OPERation?

Front Panel

Access: Shift-3 (Sweep), Sweep (Single), Trigger Sweep

13-8 :MEASure Subsystem

These commands take the instrument from its current state, enable the specified measurement and put the instrument into single sweep mode. They correct any parameters that are invalid given the new measurement state such that a valid measurement can take place. Other settings may be changed; see the documentation of CONFigure for each measurement. They then initiate the measurement. When the measurement is complete, they return the result.

To make a measurement with settings other than the “default” measurement settings applied by CONFigure, do the following:

- Send the appropriate CONFigure command to set the desired measurement.
- Modify the settings as required.
- Send the appropriate READ command to measure and return the result.

To get the current measurement data, use the appropriate FETCh command.

:MEASure:DEMod:4x4:TIMEalign?

Title: Measure Tx Time Alignment Data (4x4 MIMO configuration)

Description: Sets the active measurement to Tx Time Alignment, sets the default measurement parameters, triggers a new measurement, and returns the measured values. This command may not be supported if your instrument is loaded with older firmware, in which case you may upgrade to the current firmware version or use the :MEASure:DEMod:TIMEalign? command, instead. Refer to your instrument User Guide for instructions on updating firmware.

Data is returned as 14 comma-delimited values: EVM (rms) in %, EVM (pk) in %, Ref Signal (RS) Power in dBm, Sync Signal (SS) Power in dBm, Carrier Frequency in MHz, Freq Error in Hz, Freq Error in ppm, Cell ID, and Time Alignment Error (TAE) in nanoseconds for each of antenna pairs 1-2, 1-3, 1-4, 2-3, 2-4, and 3-4. “-” is returned for each data that is not valid at that instance.

Front Panel

Access: Measurements, Modulation, Tx Time Alignment

:MEASure:DEMod:CCPData?

Title: Read Modulation Control Channel Power Data

Description: Sets the active measurement to Control Channel Power, sets the default measurement parameters, triggers a new measurement, and returns the measured values: RS_POWER, PSS_POWER, SSS_POWER, BCH_POWER, CFI_POWER, RS_TOTAL_POWER, PSS_TOTAL_POWER, SSS_TOTAL_POWER, BCH_TOTAL_POWER, CFI_TOTAL_POWER, TOTAL_POWER, TOTAL_CHANNEL_POWER. Data returned is the same for Bar Graph or Table mode. The Control Channel Power measurement must be the active measurement.

Front Panel

Access: Measurements, Modulation, Control Channel Power

:MEASure:DEMod:CONStln?

Title: Measure Constellation

Description: Triggers a new Constellation measurement and returns the results. The Constellation measurement must be the active measurement (specified by :CONFigure:DEMod CONStln). The current measurement can be queried using the command :CONFigure?

Data is returned as 10 comma-delimited values: EVM (rms) in %, EVM (pk) in %, Ref Signal (RS) Power in dBm, Sync Signal (SS) Power in dBm, Carrier Frequency in MHz, Freq Error in Hz, Freq Error in ppm, Cell ID, the number of measurements used in the frequency error average (if on), and OSTP (OFDM Symbol Transmit Power) in dBm. "--" is returned for each data that is not valid at that instance.

Front Panel

Access: Measurements, Modulation, Constellation

:MEASure:DEMod:TIMEalign?

Title: Measure Tx Time Alignment Data

Description: Sets the active measurement to Tx Time Alignment, sets the default measurement parameters, triggers a new measurement, and returns the measured values.

Data is returned as 9 comma-delimited values: EVM (rms) in %, EVM (pk) in %, Ref Signal (RS) Power in dBm, Sync Signal (SS) Power in dBm, Carrier Frequency in MHz, Freq Error in Hz, Freq Error in ppm, Cell ID, and Time Alignment Error (TAE) in nanoseconds. "--" is returned for each data that is not valid at that instance.

Front Panel

Access: Measurements, Modulation, Tx Time Alignment

:MEASure:OTA:C4AGGregation?

Title: Measure OTA Carrier Aggregation (4x4 MIMO configuration)

Description: Sets the active measurement to Carrier Aggregation, triggers a new measurement, and returns the measured values. This command may not be supported if your instrument is loaded with older firmware, in which case you may upgrade to the current firmware version or use the :MEASure:OTA:CAGGregation? command, instead. Refer to your instrument User Guide for instructions on updating firmware.

Data is returned as 70 comma delimited values. The values consist of 5 sets of Component Carrier (CC) data, with each set containing 14 fields (CP, tx1 antenna, tx2 antenna, tx3 antenna, tx4 antenna, RS Power, RS Delta Power, SS Power, EVM(rms), EVM(pk), Freq Error, Freq Error (ppm), TAE (nS), and Cell ID). The data is in sequential CC order. A field with "--" means the data was invalid. An inactive Component Carrier will show N/A for the entire set of data.

Front Panel

Access: Measurements, Over-the-Air, Carrier Aggregation

:MEASure:OTA:CAGgregation?

Title: Measure OTA Carrier Aggregation

Description: Sets the active measurement to Carrier Aggregation, triggers a new measurement, and returns the measured values.

Data is returned as 60 comma delimited values. The values consist of 5 sets of Component Carrier (CC) data with each set containing 12 fields (CP, tx1 antenna, tx2 antenna, RS Power, RS Delta Power, SS Power, EVM(rms), EVM(PK), Freq Error, Freq Error (ppm), TAE (nS), and Cell ID). The data is in sequential CC order. A field with "--" means the data was invalid. An inactive Component Carrier will show N/A for the entire set of data.

Front Panel

Access: Measurements, Over-the-Air, Carrier Aggregation

:MEASure:OTA:MAPping?

Title: Measure OTA Coverage Mapping

Description: Sets the active measurement to OTA Coverage Mapping, sets the default measurement parameters, triggers a new measurement, and returns the measured values.

Data is returned as six sets of comma-delimited values. Each set consists of: Cell ID, Group ID, Sector ID, S-SS Power, RSRP, RSRQ, and SINR.

Following the six sets of data is a final value for the Dominance. "--" is returned for each data that is not valid at that instance.

Default Unit: dBm

Front Panel

Access: Measurements, Over-the-Air, Mapping

:MEASure:OTA:MAPping:RUN START|STOP**:MEASure:OTA:MAPping:RUN?**

Title: Coverage Mapping Data Collection

Description: Turns On/Off the coverage mapping data collection. The instrument must be in Mapping measurement mode for the command to be effective.

No data is returned.

Front Panel

Access: Measurements, Over-the-Air, Mapping, Start/Stop Data Collection (Main menu key)

:MEASure:OTA:SCANner?

Title: Measure OTA Scanner

Description: Sets the active measurement to OTA Scanner, sets the default measurement parameters, triggers a new measurement, and returns the measured values.

Data is returned as six sets of comma-delimited values. Each set consists of: Cell ID, Group ID, Sector ID, S-SS Power, RSRP, RSRQ, and SINR.

Following the six sets of data is a final value for the Dominance. "--" is returned for each data that is not valid at that instance.

Default Unit: dBm

Front Panel

Access: Measurements, Over-the-Air, Scanner

:MEASure:OTA:TXTEst?

Title: Measure OTA Tx Test

Description: Sets the active measurement to OTA Tx Test, sets the default measurement parameters, triggers a new measurement, and returns the measured values.

Data is returned as three sets of comma-delimited values. Each set consists of: Cell ID, Group ID, Sector ID, S-SS Power, RSRP, RSRQ, and SINR.

Following the three sets of data is an additional set of four results: Dominance, Antenna count, Average Power, Delta Power.

--" is returned for each data that is not valid at that instance.

Default Unit: dBm

Front Panel

Access: Measurements, Over-the-Air, Tx Test

:MEASure:RF:ACLR?

Title: Measure Adjacent Channel Leakage Ratio

Description: Sets the active measurement to adjacent channel power ratio, sets the default measurement parameters, triggers a new measurement and returns the main channel(s) power, and adjacent channel(s) power. It is a combination of the commands :CONFigure:RF ACLR and :READ:RF:ACLR? Refer to "[:READ:RF:ACLR?](#)" on page 13-27 for a description of the returned data.

Default Unit: dBm

Front Panel

Access: Measurements, RF, ACLR

:MEASure:RF:SEM?

Title: Measure Spectral Emission Mask

Description: Sets the active measurement to Spectral Emission Mask and returns a PASS or FAIL result.

Front Panel

Access: Measurements, RF, Spectral Emission Mask

:MEASure:RF:SPECTrum?

Title: Measure RF Spectrum

Description: Sets the active measurement to Channel Spectrum, sets the default measurement parameters, triggers a new measurement and returns the Channel Power and Occupied Bandwidth measurement results. It is a combination of the following command :CONFigure:RF SPECTrum and :READ:RF:SPECTrum?. Data is returned as 2 comma-delimited values: Channel Power in dBm and Occupied bandwidth in MHz.

Front Panel

Access: Measurements, RF, Channel Spectrum

13-9 :READ Subsystem

This set of commands combines the ABORt, INITiate and FETCh commands. It aborts any current triggering sequence and sets the trigger state to idle. It then initiates a new active measurement (i.e. begins the collection of new data). When the measurement is complete, it returns the result. These commands will not switch to another measurement.

To get the current measurement data, use the FETCh command.

:READ:DEMod:4x4:TIMEalign?

Title: Read Tx Time Alignment Data (4x4 MIMO configuration)

Description: Triggers a new Time Alignment measurement and returns the results. The Tx Time Alignment measurement must be the active measurement (specified by :CONFigure:DEMod TIMEalign). The current measurement can be queried using the command :CONFigure?

This command may not be supported if your instrument is loaded with older firmware, in which case you may upgrade to the current firmware version or use the :READ:DEMod:TIMEalign? command, instead. Refer to your instrument User Guide for instructions on updating firmware.

Data is returned as 14 comma-delimited values: EVM (rms) in %, EVM (pk) in %, Ref Signal (RS) Power in dBm, Sync Signal (SS) Power in dBm, Carrier Frequency in MHz, Freq Error in Hz, Freq Error in ppm, Cell ID, and Time Alignment Error (TAE) in nanoseconds for each of antenna pairs 1-2, 1-3, 1-4, 2-3, 2-4, and 3-4. "--" is returned for each data that is not valid at that instance.

Front Panel

Access: Measurements, Modulation, Tx Time Alignment

:READ:DEMod:CONStln?

Title: Read Constellation

Description: Triggers a new Constellation measurement and returns the results. The Constellation measurement must be the active measurement (specified by :CONFigure:DEMod CONStln). The current measurement can be queried using the command :CONFigure?

Data is returned as 10 comma-delimited values: EVM (rms) in %, EVM (pk) in %, Ref Signal (RS) Power in dBm, Sync Signal (SS) Power in dBm, Carrier Frequency in MHz, Freq Error in Hz, Freq Error in ppm, Cell ID, the number of measurements used in the frequency error average (if on), and OSTP (OFDM Symbol Transmit Power) in dBm. "--" is returned for each data that is not valid at that instance.

Front Panel

Access: Measurements, Modulation, Constellation

:READ:DEMod:TIMEalign?

Title: Read Tx Time Alignment Data

Description: Triggers a new Time Alignment measurement and returns the results. The Tx Time Alignment measurement must be the active measurement (specified by :CONFigure:DEMod TIMEalign). The current measurement can be queried using the command :CONFigure?

Data is returned as 9 comma-delimited values: EVM (rms) in %, EVM (pk) in %, Ref Signal (RS) Power in dBm, Sync Signal (SS) Power in dBm, Carrier Frequency in MHz, Freq Error in Hz, Freq Error in ppm, Cell ID, and Time Alignment Error (TAE) in nanoseconds. "--" is returned for each data that is not valid at that instance.

Front Panel

Access: Measurements, Modulation, Tx Time Alignment

:READ:OTA:C4AGGregation?

Title: Read OTA Carrier Aggregation (4x4 MIMO configuration)

Description: Triggers a new Carrier Aggregation measurement and returns the results. OTA Carrier Aggregation must be the active measurement. This command may not be supported if your instrument is loaded with older firmware, in which case you may upgrade to the current firmware version or use the :READ:OTA:CAGGregation? command, instead. Refer to your instrument User Guide for instructions on updating firmware.

Data is returned as 70 comma delimited values. The values consist of 5 sets of Component Carrier (CC) data, with each set containing 14 fields (CP, tx1 antenna, tx2 antenna, tx3 antenna, tx4 antenna, RS Power, RS Delta Power, SS Power, EVM(rms), EVM(pk), Freq Error, Freq Error (ppm), TAE (nS), and Cell ID). The data is in sequential CC order. A field with "--" means the data was invalid. An inactive Component Carrier will show N/A for the entire set of data.

Front Panel

Access: Measurements, Over-the-Air, Carrier Aggregation

:READ:OTA:CAGgregation?

Title: Read OTA Carrier Aggregation

Description: Triggers a new Carrier Aggregation measurement and returns the results. OTA Carrier Aggregation must be the active measurement.

Data is returned as 60 comma delimited values. The values consist of 5 sets of Component Carrier (CC) data, with each set containing 12 fields (CP, tx1 antenna, tx2 antenna, RS Power, RS Delta Power, SS Power, EVM(rms), EVM(PK), Freq Error, Freq Error (ppm), TAE (nS), and Cell ID). The data is in sequential CC order. A field with "--" means the data was invalid. An inactive Component Carrier will show N/A for the entire set of data.

Front Panel

Access: Measurements, Over-the-Air, Carrier Aggregation

:READ:OTA:MAPping?

Title: Read OTA Coverage Mapping

Description: Triggers a new OTA Coverage Mapping measurement and returns the results. The OTA Mapping measurement must be the active measurement (specified by :CONFigure:OTA MAPping). The current measurement can be queried using the command :CONFigure?

Data is returned as six sets of comma-delimited values. Each set consists of: Cell ID, Group ID, Sector ID, S-SS Power, RSRP, RSRQ, and SINR.

Following the six sets of data is a final value for the Dominance. "--" is returned for each data that is not valid at that instance.

Default Unit: dBm

Front Panel

Access: Measurements, Over-the-Air, Mapping

:READ:OTA:SCANner?

Title: Read OTA Scanner

Description: Triggers a new OTA Scanner measurement and returns the results. The OTA Scanner measurement must be the active measurement (specified by :CONFigure:OTA SCANner). The current measurement can be queried using the command :CONFigure?

Data is returned as six sets of comma-delimited values. Each set consists of: Cell ID, Group ID, Sector ID, S-SS Power, RSRP, RSRQ, and SINR.

Following the six sets of data is a final value for the Dominance. "--" is returned for each data that is not valid at that instance.

Default Unit: dBm

Front Panel

Access: Measurements, Over-the-Air, Scanner

:READ:OTA:TXTest?

Title: Read OTA Tx Test

Description: Triggers a new OTA Tx Test measurement and returns the results. The OTA Tx Test measurement must be the active measurement (specified by :CONFigure:OTA Tx Test). The current measurement can be queried using the command :CONFigure?

Data is returned as three sets of comma-delimited values. Each set consists of: Cell ID, Group ID, Sector ID, S-SS Power, RSRP, RSRQ, and SINR.

Following the three sets of data is an additional set of four numbers: Dominance, Antenna count, Average Power, Delta Power. "--" is returned for each data that is not valid at that instance.

Default Unit: dBm

Front Panel

Access: Measurements, Over-the-Air, Tx Test

:READ:PFail?

Title: Read PASS/FAIL

Description: Triggers a new PASS/FAIL measurement and returns the results. It is a combination of the commands :ABORT; :INITiate; :FETCh:PFail? The PASS/FAIL measurement must be active. The current measurement can be queried using :CONFigure?

Related Command: :FETCh:PFail?
:CONFigure PFail
:MEASure:PFail?

Front Panel

Access: Measurements, Pass/Fail Test

:READ:RF:ACLR?

Title: Read Adjacent Channel Leakage Ratio

Description: Triggers a new Adjacent Channel Leakage Ratio measurement and returns the results: Power levels for each channel (both absolute and relative). If the instrument is sweeping, it will not return until the sweep is complete. If the instrument is not sweeping and the current data is not valid it will return error -230. This could occur if there was a *RST immediately before the :FETCh? or if a measurement parameter was changed without an :INITiate.

Data is returned as 11 comma-separated values: Main channel power, Left alternate channel power - relative, absolute, Left adjacent channel power - relative, absolute, Main channel power - relative, absolute, Right adjacent channel power - relative, absolute, Right Alternate channel power - relative, absolute.

Default Unit: dBm

Front Panel

Access: Measurements, RF, ACLR

:READ:RF:SEM?

Title: Read RF Spectral Emmision Mask

Description: Triggers a new RF Spectral Emission Mask measurement and returns a PASS or FAIL result. It is a combination of the commands :ABORT; :INITiate; :FETCh:RF:SEM? The current measurement can be queried using :CONFigure?

Front Panel

Access: Measurements, RF, Spectral Emission Mask

:READ:RF:SPECTrum?

Title: Read RF Spectrum

Description: Triggers a new RF Spectrum measurement and returns the results: Channel Power and Occupied BW measurement. It is a combination of the commands :ABORT; :INITiate; :FETCh:RF:SPECTrum? The current measurement can be queried using :CONFigure?

Data is returned as 2 comma-delimited values: Channel Power in dBm and Occupied bandwidth measurement in MHz.

Related Command: :FETCh:RF:SPECTrum?
:CONFigure:RF SPECTrum
:MEASure:RF:SPECTrum?

Front Panel

Access: Measurements, RF, Channel Spectrum

13-10 :UNIT Subsystem

The unit subsystem is used to modify the default units used for related parameters. These changes affect parameters in both commands and responses.

:UNIT:POWER DBM|W

:UNIT:POWER?

Title: Measurement Units

Description: Sets>Returns the current display mode for power values as either dBm or in watts.

Parameter: DBM|W

Parameter Type: <char>

Default Value: dBm

Front Panel

Access: Amplitude, Units

13-11 [:SENSE] Subsystem

The commands in this subsystem relate to device-specific parameters, not signal-oriented parameters.

[:SENSE]:4TAE:ACTive OFF|ON

[:SENSE]:4TAE:ACTive?

Title: Time Alignment Error (4x4 MIMO configuration)

Description: Sets the state of the TAE measurement for OTA carrier aggregation. In 2x2 MIMO, use the command [:SENSE]:TAE:ACTive.

Parameter: OFF|ON

Parameter Type: <boolean>

Front Panel

Access: Measurements, Over-the-Air, Carrier Aggregation, TAE

[:SENSE]:BANDWidth[:RESolution] 1.4|3|5|10|15|20

[:SENSE]:BANDWidth[:RESolution]?

Title: Bandwidth Resolution

Description: Sets the channel bandwidth. Note that available bandwidths may be instrument and option dependent.

Parameter: 1.4|3|5|10|15|20

Parameter Type: <char>

Default Value: The default bandwidth is 10 MHz.

Front Panel

Access: Setup, BW

[:SENSE]:CC{1|2|3|4|5}:ACTive OFF|ON

[:SENSE]:CC{1|2|3|4|5}:ACTive?

Title: Active Component Carrier

Description: Sets the specified Component Carrier (CC) to be on or off.

Parameter: OFF|ON

Parameter Type: <boolean>

Front Panel

Access: Measurements, Over-the-Air, Carrier Aggregation, CC#, CC#

[:SENSE]:CC{1|2|3|4|5}:BANDWidth 1.4|3|5|10|15|20

[:SENSE]:CC{1|2|3|4|5}:BANDWidth?

Title: Component Carrier Bandwidth

Description: Sets the channel bandwidth of the specified Component Carrier (CC).

Parameter: 1.4|3|5|10|15|20

Front Panel

Access: Measurements, Over-the-Air, Carrier Aggregation, CC#, CC#, BW

[:SENSE]:CC{1|2|3|4|5}:CHANnel <number>

[:SENSE]:CC{1|2|3|4|5}:CHANnel?

Title: Component Carrier Channel

Description: Sets the channel number for the selected signal standard for the specified Component Carrier (CC).

Parameter: <number>

Front Panel

Access: Measurements, Over-the-Air, Carrier Aggregation, CC#, CC#, Channel

[:SENSE]:CC{1|2|3|4|5}:FREQuency <freq>

[:SENSE]:CC{1|2|3|4|5}:FREQuency?

Title: Component Carrier Frequency

Description: Sets the center frequency of the specified Component Carrier (CC).

Parameter: <freq>

Parameter Type: <NRf>

Front Panel

Access: Measurements, Over-the-Air, Carrier Aggregation, CC#, CC#, Center Freq

[:SENSE]:CC{1|2|3|4|5}:SIGStandard <string>

[:SENSE]:CC{1|2|3|4|5}:SIGStandard?

Title: Component Carrier Signal Standard

Description: Selects the desired signal standard from the list. The <string> argument is the name of the desired signal standard as displayed in the instrument's current signal standard list. The list can be displayed on the instrument by choosing the Signal Standard submenu button in the Freq menu. The list can also be downloaded remotely and viewed using Anritsu Master Software Tools. For example, if the desired Signal Standard is P-GSM 900 - Uplink, then the value of the <string> argument would be "P-GSM 900 - Uplink".

The query form of this command returns the name of the currently selected Signal Standard from the list.

Parameter: <string>

Parameter Type: <char>

Front Panel

Access: Measurements, Over-the-Air, Carrier Aggregation, CC#, CC#, Signal Standard

[:SENSe]:CELLID <char>

[:SENSe]:CELLID?

Title: Cell ID

Description: Sets the Cell ID value used when Sync Type is set to 'RS'.

Parameter: (the known Cell ID)

Parameter Type: <char>

Front Panel

Access: Setup, Sync (RS), Cell ID

[:SENSe]:EMF:STATE OFF|ON|0|1

[:SENSe]:EMF:STATE?

Title: EMF State

Description: Switches EMF ON or OFF.

The query form of this command returns a 0 or 1 when EMF state is OFF or ON, respectively.

Note: EMF will turn ON only if the start and stop frequencies are within the frequency range of the signal analyzer and isotropic antenna used. The antenna must be connected.

Parameter: OFF|ON|0|1

Parameter Type: <boolean>

Default Value: OFF

Front Panel

Access: Measurements, Over-the-Air, EMF

[:SENSE]:EVM:MODE AUTO|PBCHonly

[:SENSE]:EVM:MODE?

Title: Set EVM Mode

Description: Sets/Returns the EVM Mode to either Auto or PBCH Only.

Parameter: AUTO|PBCHonly

Parameter Type: <char>

Default Value: AUTO

Front Panel

Access: Setup, EVM Mode

[:SENSE]:FREQUENCY:CENTER <freq>

[:SENSE]:FREQUENCY:CENTER?

Title: Center Frequency

Description: Sets the center frequency.

Parameter: <freq>

Default Value: 1 GHz

Default Unit: Hz

Range: 10 MHz to 4 GHz

Front Panel

Access: Freq, Center Freq

[:SENSE]:FREQUENCY:SIGSTANDARD:CHANNEL <number>

[:SENSE]:FREQUENCY:SIGSTANDARD:CHANNEL?

Title: Channel Selection

Description: Sets the channel number for the selected signal standard.

Parameter: <number>

Front Panel

Access: Frequency, Channel

[:SENSE]:FREQUENCY:SIGSTANDARD:NAME [String]

[:SENSE]:FREQUENCY:SIGSTANDARD:NAME?

Title: Signal Standard

Description: Selects the desired signal standard from the list. The <string> argument is the name of the desired signal standard as displayed in the instrument's current signal standard list. The list can be displayed on the instrument by choosing the Signal Standard submenu button in the Freq menu. The list can also be downloaded remotely and viewed using Anritsu Master Software Tools. For example, if the desired Signal Standard is P-GSM 900 - Uplink, then the value of the <string> argument would be "P-GSM 900 - Uplink".

The query form of this command will return the name of the currently selected Signal Standard from the list.

Parameter: <string>

Front Panel

Access: Freq, Signal Standard

[:SENSE]:LTE:STATUS?

Title: Sweep Status

Description: Returns 1 when the sweep is complete. Returns 0 when the sweep is in progress.

Front Panel

Access: None

[:SENSE]:POWER[:RF]:RANGE[:IMMEDIATE]

Title: Amplitude Range

Description: Re-calculates amplitude range. Note that issuing this command will set the automatic dynamic range OFF.

Related Command: [:SENSE]:POWER[:RF]:RANGE:AUTO

Front Panel

Access: Amplitude, Adjust Range

[:SENSE]:POWER[:RF]:RANGE:AUTO <Boolean (default=1 [ON])>

[:SENSE]:POWER[:RF]:RANGE:AUTO?

Title: Automatic Amplitude Range

Description: Sets the automatic amplitude range. Setting the value to ON or 1 will result in the amplitude range being coupled to the detected input signal level. Setting the value to OFF or 0 will result in the input attenuation being uncoupled from the input signal level. That is, changing the input signal level will not change the amplitude range. When this command is issued, the amplitude range itself will not change. The default value is ON. That is, sending :SENS:POW:RANG:AUTO is equivalent to sending :SENS:POW:RANG:AUTO ON.

Parameter: OFF|ON|0|1

Parameter Type: <boolean>

Default Value: ON

Related Command: [:SENSE]:POWER[:RF]:RANGE

Front Panel

Access: Amplitude, Auto Range

[:SENSE]:RF:SPECTrum:SPAN Auto|1.4|3|5|10|15|20|30

[:SENSE]:RF:SPECTrum:SPAN?

Description: Sets the span for the Spectrum view. For example, setting the value to 5 will set the span for the Spectrum view to 5 MHz and setting the value to 20 will set the span for the Spectrum view to 20 MHz.

Parameter: Auto|1.4|3|5|10|15|20|30

Default Value: Auto

Default Unit: MHz

Front Panel

Access: Measurements, RF, Channel Spectrum, Span

[:SENSE]:SYNC:TYPE SS|RS

[:SENSE]:SYNC:TYPE?

Title: Set Sync Type

Description: Sets the sync type setting.

Parameter: SS|RS

Parameter Type: <char>

Default Value: SS

Front Panel

Access: Setup, Sync, Sync Type

[:SENSE]:TAE:ACTive OFF|ON

[:SENSE]:TAE:ACTive?

Title: Time Alignment Error

Description: Sets the state of the TAE measurement for OTA carrier aggregation.

Parameter: OFF|ON

Parameter Type: <boolean>

Front Panel

Access: Measurements, Over-the-Air, Carrier Aggregation, TAE

Chapter 14 — AM/FM/PM Commands

14-1 :CALCulate Subsystem

The commands in this subsystem process data that has been collected via the SENSE subsystem. Commands may require the instrument to be in the proper mode or set up to use the feature of the command. For example, Marker commands function in one of the spectrum modes, Summary commands require the Summary mode. Use the :AFP:DEM:MODE command to set the desired mode.

:CALCulate:MARKer{1|2|3|4|5|6}[:STATE] OFF|ON|0|1

:CALCulate:MARKer{1|2|3|4|5|6}[:STATE]?

Title: Marker State

Description: Sets the specified marker on/off.

Parameter: OFF|ON|0|1

Parameter Type: <boolean>

Default Value: OFF

Example: To turn off reference marker #1:

```
:CALCulate:MARKer1:STATE OFF
```

Front Panel Access: Marker, On/Off

:CALCulate:MARKer{1|2|3|4|5|6}:DELTA[:STATE] OFF|ON|0|1

:CALCulate:MARKer{1|2|3|4|5|6}:DELTA[:STATE]?

Title: Delta Marker State

Description: Sets the specified delta marker on or off.

Parameter: OFF|ON|0|1

Parameter Type: <boolean>

Default Value: OFF

Example: To turn on delta marker #3:

```
:CALCulate:MARKer3:DELTA ON
:CALCulate:MARKer3:DELTA 1
:CALCulate:MARKer3:DELTA:STATE ON
:CALCulate:MARKer3:DELTA:STATE 1
```

To turn off delta marker #6:

```
:CALCulate:MARKer6:DELTA OFF
:CALCulate:MARKer6:DELTA:STATE OFF
:CALCulate:MARKer6:DELTA:STATE 0
```

Front Panel Access: Marker, Delta

:CALCulate:MARKer{1|2|3|4|5|6}:DELTA:X <x-parameter>
:CALCulate:MARKer{1|2|3|4|5|6}:DELTA:X?

Title: Delta Marker X Value

Description: Sets the location of the delta marker on the x-axis at the specified location <x-parameter> plus the reference marker x-axis. <x-parameter> is defined in the current x-axis units. The query version of the command returns the location of the delta marker on the x-axis.

Parameter: <x-parameter>

Default Unit: Hz or seconds if in Audio Waveform.

Example: If both the reference and delta marker #1 is currently at 1 GHz on the x-axis, send the command below to set the delta marker #1 to 2 GHz on the x-axis:

```
:CALCulate:MARKer1:DELTA:X 1GHz
```

(In Audio Waveform) If both the reference and delta marker #1 is currently at 25 μ s on the x-axis, send the command below to set the delta marker to 50 μ s on the x-axis:

```
:CALCulate:MARKer1:DELTA:X 25 $\mu$ s
```

Related Command: :CALCulate:MARKer[1|2|3|4|5|6]:X

Front Panel Access: Marker, Delta

:CALCulate:MARKer{1|2|3|4|5|6}:DELTA:Y?

Title: Delta Marker Read Y Value

Description: Reads the current absolute Y value for the specified delta marker. The units are the units of the y-axis. In RF spectrum view, the value is returned in dBm. In Audio Spectrum or Audio Waveform view, the value is returned in % for AM, Hz for FM and Radians for PM.

Default Unit: Current y-axis unit

:CALCulate:MARKer{1|2|3|4|5|6}[:SET]:CENTER

Title: Marker Frequency to Center

Description: In RF spectrum view, this command sets the center frequency equal to the frequency of the specified marker. Note that this will result in a change to the start and stop frequencies and may also result in a change to the span. Note that this command is not valid in Audio Spectrum, Audio Waveform and Summary view.

Front Panel Access: Marker, Marker Freq to Center

:CALCulate:MARKer{1|2|3|4|5|6}:MAXimum

Title: Marker (Maximum) Peak Search

Description: Puts the specified marker at the maximum amplitude in the trace.

Front Panel Access: Marker, Marker [1/2/3/4/5/6], Peak Search
 Marker, Marker [1/2/3/4/5/6], More Peak Options, Peak Search

:CALCulate:MARKer{1|2|3|4|5|6}[:SET]:RLEVel

Title: Marker to Reference Level

Description: Sets the reference level equal to the measured amplitude of the specified marker. Note that this may result in a change to the input attenuation. Note that this command is not valid in Audio Spectrum, Audio Waveform and Summary view.

Front Panel Access: Marker, Marker to Ref Lvl

:CALCulate:MARKer{1|2|3|4|5|6}:X <x-parameter>**:CALCulate:MARKer{1|2|3|4|5|6}:X?**

Title: Marker X Value

Description: Sets the location of the marker on the x-axis at the specified location. <x-parameter> is defined in the current x-axis units. The query version of the command returns the location of the marker on the x-axis. Note that the marker is snapped to the data point closest to the specified value. If the specified marker is not on it is set to on.

Parameter: <x-parameter>

Default Unit: Hz or seconds if in Audio Waveform.

Example: To set reference marker #2 to 5 hertz on the x-axis:

```
:CALCulate:MARKer2:X 5
:CALCulate:MARKer2:X 5Hz
```

To set reference marker #1 to 1.5 GHz on the x-axis:

```
:CALCulate:MARKer:X 1.5GHz
:CALCulate:MARKer1:X 1.5GHz
```

(In Audio Waveform) To set reference marker #3 to 1.5 milli-seconds on the x-axis:

```
:CALCulate:MARKer3:X .0015
:CALCulate:MARKer3:X 1.5ms
```

:CALCulate:MARKer{1|2|3|4|5|6}:Y?

Title: Marker Read Y Value

Description: In RF spectrum view, the value is returned in dBm. In Audio Spectrum or Audio Waveform view, the value is returned in % for AM, Hz for FM and Radians for PM.

Default Unit: Current y-axis unit

:CALCulate:MARKer:AOff

Title: Turn All Markers Off

Description: Turns off all markers.

Front Panel Access: Marker, More, All Markers Off

:CALCulate:MARKer:TABLE[:STATE] OFF|ON**:CALCulate:MARKer:TABLE[:STATE]?**

Title: Marker Table State

Description: Turns the Marker Table on or off. Setting the value to ON will turn on the marker table. Setting the value to OFF will turn off the marker table.

Parameter: OFF|ON

Parameter Type: <boolean>

Default Value: OFF

Example: To turn on marker table:

:CALCulate:MARKer:TABLE ON

14-2 :DISPlay Subsystem

This subsystem provides commands that modify the display of data for the user. They do not modify the way in which data are returned to the controller.

:DISPlay:WINDow:TRACe:Y:ADJust

Title: Adjust Range

Description: Automatically adjusts reference level if input signal strength is too high (ADC error) or too low.

Example: `:DISPlay:WINDow:TRACe:Y:ADJust`

Front Panel Access: Amplitude, Adjust Range

:DISPlay:WINDow:TRACe:Y[:SCALE]:PDIVision <rel ampl> **:DISPlay:WINDow:TRACe:Y[:SCALE]:PDIVision?**

Title: Scale

Description: Sets the scale (dB/division) for the y-axis in RF Spectrum view.

Parameter: <rel ampl>

Default Value: 10 dB/div

Default Unit: dB

Range: 1 dB to 15 dB

Front Panel Access: Amplitude, Scale

:DISPlay:WINDow:TRACe:Y:AFPanalyzer:PWR:OFFSet <rel ampl> **:DISPlay:WINDow:TRACe:Y:AFPanalyzer:PWR:OFFSet?**

Title: Power Offset

Description: Sets the power offset value for the y-axis in RF Spectrum view.

Parameter: <rel ampl>

Default Value: 0 dB

Default Unit: dB

Range: -100 dB to 100 dB

Front Panel Access: Amplitude, Power Offset

14-3 :FORMat Subsystem

This subsystem contains commands that determine the formatting of numeric data when it is transferred. The format setting affects data in specific commands only. If a command is affected, it is noted in the command description.

```
:FORMat[:READings][:DATA] ASCii|INTeger,32|REAL,[<length>]
:FORMat[:READings][:DATA]?
```

Title: Numeric Data Format

Description: This command specifies the format in which data is returned in certain commands. The optional <length> parameter is needed for REAL format only. It defines the length of the floating point number in bits. Valid values are 32 and 64. If no length is specified, the default length of REAL data is set to 64 bits.

ASCii format returns the data in comma-separated ASCII format. The units are dBm for RF Spectrum, % for AM Audio Spectrum/Waveform, Hz for FM Audio Spectrum/Waveform, Radians for PM Audio Spectrum/Waveform.

This format requires many more bytes so it is the slowest format.

INTeger,

32 values are signed 32-bit integers in little-endian byte order. This format

returns the data in 4-byte blocks. The units are mdBm for RF Spectrum, 1000*% for AM Audio Spectrum/Waveform, Hz for FM Audio Spectrum/Waveform, milli-Radians for PM Audio Spectrum/Waveform.

For example, if the measured result was -12.345 dBm, that value would be sent as -12345. REAL,32 values are 32-bit floating point numbers conforming to the IEEE 754 standard in little-endian byte order. This format returns the data in 4-byte binary format. The units are dBm for RF Spectrum, % for AM Audio Spectrum/Waveform,

Hz for FM Audio Spectrum/Waveform, Radians for PM Audio Spectrum/Waveform.

REAL,64 values are 64-bit floating point numbers conforming to the IEEE 754 standard in little-endian byte order. This format returns the data in 8-byte binary format. The units are dBm for RF Spectrum, % for AM Audio Spectrum/Waveform, Hz for FM Audio Spectrum/Waveform, Radians for PM Audio Spectrum/Waveform.

Both INTeger and REAL formats return a definite block length. Each transfer begins with an ASCII header such as #42204 for INTeger,32 and REAL,32 and #44408 for REAL,64. The first digit represents the number of following digits in the header (in this example, 4). The remainder of the header indicates the number of bytes that follow the header (in this example, 2204 for INT,32 and REAL,32 and 4408 for REAL,64). Divide the number of following bytes by the number of bytes in the data format chosen

(4 for both INTeger,32 and REAL,32, and 8 for REAL,64) to get the number of data points (in this example, 551).

Parameter: ASCii | INTeger,32 | REAL,[<length>]

Parameter Type: <char>

Default Value: ASCii

Related Command: :TRACe [:DATA]

14-4 :INITiate Subsystem

This subsystem controls the triggering of measurements.

:INITiate[:IMMEDIATE]

Title: Trigger Sweep/Measurement

Description: Initiates a sweep/measurement. If :INITiate:CONTinuous is set to ON, this command is ignored. Use this command in combination with :STATus:OPERation? to synchronize the capture of one complete set of data. When this command is sent, the “sweep complete” bit of :STATus:OPERation? is set to 0, indicating that the measurement has not completed. The data collection is then triggered. The controlling program can poll :STATus:OPERation? to determine the status. When the “sweep complete” bit is set to 1, data is ready to be retrieved. An :INITiate[:IMMEDIATE] command must be issued for each additional sweep desired.

Related Command: :INITiate:CONTinuous
:STATus:OPERation?

Front Panel Access: Shift-3 (Sweep), Manual Trigger

:INITiate:CONTinuous OFF|ON|0|1 **:INITiate:CONTinuous?**

Title: Continuous/Single Sweep

Description: Specifies whether the sweep/measurement is triggered continuously. If the value is set to ON or 1, another sweep/measurement is triggered as soon as the current one completes. If continuous is set to OFF or 0, the instrument enters the “idle” state and waits for the :INITiate[:IMMEDIATE] command or for :INITiate:CONTinuous ON. The default value is ON. That is, sending :INIT:CONT is equivalent to sending :INIT:CONT ON. The query version of the command returns a 1 if the instrument is continuously sweeping/measuring and returns a 0 if the instrument is in single sweep/measurement mode. Note that rapid toggling between ON and OFF is not allowed. The instrument must be allowed to make a full sweep before toggling can be done.

Parameter: OFF|ON|0|1

Parameter Type: <boolean>

Default Value: ON

Related Command: :INITiate[:IMMEDIATE]

Front Panel Access: Shift-3 (Sweep), Sweep

14-5 :MMEMory Subsystem

The Mass Memory subsystem contains functions that provide access to the instrument's setup and data storage.

:MMEMory:DELeTe <filename>

Title: Delete Setup/Measurement

Description: Removes a file specified by <filename> from the current mass storage device. <filename> should be enclosed in either single quotes (') or double quotes (") and it must include the file extension. Use the command MMEMory:MSIS to set the current file location.

Parameter: <filename>

Related Command: :MMEMory:STORE:STATE
:MMEMory:STORE:TRACE
:MMEMory:MSIS INTernal|USB

Front Panel Access: Shift-7 (File), Delete, Delete Selected File

:MMEMory:LOAD:STATE <integer>,<filename>

Title: Recall Setup

Description: Recalls a previously stored instrument setup in the current save location. The setup file to be loaded is specified by <filename>. <filename> should be enclosed in either single quotes (') or double quotes (") and should contain a file extension ".stp". Use the command MMEMory:MSIS to set the current save location. The <integer> parameter is not currently used, but it must be sent. Send a 1.

Parameter: <integer>, <filename>

Related Command: :MMEMory:STORE:STATE
:MMEMory:MSIS INTernal|USB

Front Panel Access: Shift-7 (File), Recall

:MMEMory:LOAD:TRACe <integer>,<filename>

Title: Recall Measurement

Description: The instrument must be in the mode of the saved trace in order to recall that trace. Use :INSTRument:SELEct or :INSTRument:NSELEct to set the mode. Recalls a previously stored measurement trace from the current save location. The saved measurement trace to be loaded is specified by <filename>. <filename> should be enclosed in either single quotes (') or double quotes (") and should contain a file extension. Note that the trace specified by <filename> should be available at the current save location.

Use the command MMEMory:MSIS to set the current save location. The <integer> parameter is not currently used, but it must be sent. Send a 1.

File name extensions:

“.spa” for SPA measurement
 “.mna” for VNA and VVM measurements
 “.hipm” for HiPM measurements
 “.pm” for PM measurements
 “.cwsG” for CWSG measurements
 “.afp” for AM/FM/PM measurements
 “.ia” for Interference Analysis measurements
 “.cs” for Channel Scanner measurements
 “.wmxd” for WiMAX
 “.wmxe” for Mobile WiMAX
 “.lte” for LTE measurements
 “.p25” for P25 measurements
 “.p252” for P25p2 measurements
 “.nxdn” for NXDN measurements
 “.dpmr” for dPMR measurements
 “.dmr2” for DMR measurements
 “.ptc” for PTC measurements
 “.tetra” for TETRA measurements
 “.nbfm” for NBFM measurements

Note: Extensions not available for T1 and Hi_PM.

Parameter: <integer>, <filename>

Example: To recall trace with file name “trace”:

```
:MMEMemory:LOAD:TRACe 1, "trace.afp"
```

Related Command: :MMEMemory:STORe:TRACe
:MMEMemory:MSIS INTernal|USB

Front Panel Access: Shift-7 (File), Recall Measurement

:MMEMemory:STORe:STATe <integer>, <filename>

Title: Save Setup

Description: Stores the current setup into the file specified by <filename>. <filename> should be enclosed in either single quotes (‘ ’) or double quotes (“ ”) and should not contain a file extension. Use the command MMEMemory:MSIS to set the current save location. The <integer> parameter is not currently used, but it must be sent. Send a value of 0.

Parameter: <integer>, <filename>

Related Command: :MMEMemory:LOAD:STATe
:MMEMemory:MSIS INTernal|USB

Front Panel Access: Shift-7 (File)

:MMEMory:STORe:TRACe <integer>,<filename>

Title: Save Measurement

Description: Stores the trace into the file specified by <filename>. <filename> should be enclosed in either single quotes (') or double quotes (" ") and should not contain a file extension. Use the command MMEMory:MSIS to set the current save location. The <integer> parameter is not currently used, but it must be sent. Send a 0. Note that existing files of the same name will not be overwritten.

Parameter: <integer>, <filename>

Example: To save the trace into the file name "trace":

```
:MMEMory:STORe:TRACe 0,"trace"
```

Related Command: :MMEMory:LOAD:TRACe
:MMEMory:MSIS INTernal|USB

Front Panel Access: Shift-7 (File), Save

14-6 :TRACe Subsystem

This subsystem contains commands related to the transfer of trace data to and from the instrument.

:TRACe [:DATA] ?

Title: Trace Data Transfer

Description: This command transfers data from the controlling program to the instrument. The query form transfers trace data from the instrument to the controller. Data is transferred to the instrument enclosed in parentheses as (<header><block>) and from the instrument as <header><block>.

The ASCII header specifies the number of data bytes. It looks like #AX, where A is the number of digits in X and X is the number of bytes in the <block>. The format of the block data in the query form is specified by :FORMat:DATA. The block data in the command form is always sent in ASCII format.

To acquire the data from the trace in the instrument, send :TRACe[:DATA]? A 551 point trace is returned as #42204<block data>. <block> data could be in either INTeger,32 or REAL,32 format. In both cases, there is 4 bytes per data point. So, 4 bytes per point * 551 data points gives 2204 bytes in <block> data. This example assumes that :FORMat:DATA INTeger,32 or :FORMat:DATA REAL,32 has been sent to the instrument before the query command is sent.

The query command will return a #0 if data is invalid for the active trace.

Related Command: :FORMat:DATA

14-7 [:SENSE] Subsystem

The commands in this subsystem relate to device-specific parameters, not signal-oriented parameters.

[:SENSE]:AFPanalyzer:AVERage:COUNT <avg count>

[:SENSE]:AFPanalyzer:AVERage:COUNT?

Title: Measurement Average

Description: Sets the average count for the measurement data when in the summary mode (use :AFP:DEM:MODE SUMM to set summary mode). The query format of this command returns the value only in the summary mode. The query format returns nothing in other measurement modes.

Parameter: <number>

Range: 1 to 65535

Front Panel Access: Shift-4 (Measure), Average (access only in Summary mode)

[:SENSE]:AFPanalyzer:DEMod:DATA?

Title: Summary data

Description: This query returns the measurement values when in the summary mode (use :AFP:DEM:MODE SUMM to set summary mode). The order of the values are as follows:

<Modulation rate> in Hz, <RMS Deviation> in % or Hz or Rad depending on the demod type, <Peak-Peak/2 Dev> in % or Hz or Rad depending on the demod type, <SINAD> in dB, <THD> in % and <Distortion> in %. All values are comma separated.

Front Panel Access: Shift-4 (Measure), Audio Spectrum/Waveform

[:SENSE]:AFPanalyzer:DEMod:MODE RFSP|AFSP|AFWV|SUMMARY

[:SENSE]:AFPanalyzer:DEMod:MODE?

Title: Demodulation Mode

Description: This command sets the demodulation mode (graph type) to RF Spectrum (RFSP), Audio Spectrum (AFSP), Audio Waveform (AFWV), or Summary (SUMM).

Parameter: RFSP|AFSP|AFWV|SUMMARY

Default Value: RFSP

Example: To set the demodulation mode to Audio Waveform:

```
SENSE:AFPanalyzer:DEMod:MODE AFWV
```

Front Panel Access: Shift-4 (Measure)

[:SENSe]:AFPanalyzer:DEMod:TYPE AM|FM|PM

[:SENSe]:AFPanalyzer:DEMod:TYPE?

Title: Demodulation Type

Description: This command sets the demodulation type.

Parameter: AM|FM|PM

Default Value: AM

Example: To set the demodulation type to FM:

```
SENSe:AFPanalyzer:DEMod:TYPE FM
```

Front Panel Access: Setup, Demod Type

[:SENSe]:AFPanalyzer:FM:SCALE <percentage>

[:SENSe]:AFPanalyzer:FM:SCALE?

Title: FM Y-axis reference level percentage

Description: This command sets the Y-axis reference level as the percentage of the IF bandwidth while in the FM Audio spectrum/waveform display.

Parameter: <percentage>

Default Value: 50

Default Unit: %

Range: 0% to 100%

Front Panel Access: Shift-4 (Measure), Audio Spectrum/Waveform, Scale: % IFBW

[:SENSe]:AFPanalyzer:IFBW <freq>

[:SENSe]:AFPanalyzer:IFBW?

Title: IF bandwidth

Description: Sets the IF bandwidth. Note that using this command turns the automatic IF bandwidth setting OFF.

Parameter: <freq>

Default Value: 300 kHz

Default Unit: Hz

Range: 1 kHz to 300 kHz in a 1:3 sequence

Related Command: :AFPanalyzer:IFBW:AUTO

Front Panel Access: Setup, IFBW

[:SENSe]:AFPanalyzer:IFBW:AUTO 0|1

[:SENSe]:AFPanalyzer:IFBW:AUTO?

Title: IF bandwidth coupling

Description: Sets the state of the coupling of the IF bandwidth to the span. Setting the value to 1 will result in the IF bandwidth being coupled to the span. That is, when the span changes, the IF bandwidth changes. Setting the value to 0 will result in the IF bandwidth being un-coupled from the span. That is, changing the span will not change the IF bandwidth.

Parameter: 0|1

Parameter Type: <boolean>

Default Value: 1

Front Panel Access: Setup, Auto IFBW

[:SENSe]:AFPanalyzer:PM:SCALE <Radians>

[:SENSe]:AFPanalyzer:PM:SCALE?

Title: PM Y-axis reference level

Description: This command sets the Y-axis reference level while in the PM Audio spectrum/waveform display.

Parameter: <number>

Default Value: 3.140

Range: 3.140 to 3140

Front Panel Access: Shift-4 (Measure), Audio Spectrum/Waveform, Scale: milli-Rad

[:SENSe]:AFPanalyzer:RFSpectrum:DATA?

Title: Summary data

Description: This query returns the measurement values while in the RF spectrum mode (use :AFP:DEM:MODE SUMM to set summary mode). The order of the values are as follows:

<carrier power> in dBm, <carrier freq> in Hz, <Occ BW> in Hz. All values are comma separated.

Front Panel Access: Shift-4 (Measure), RF Spectrum.

[:SENSe]:AFPanalyzer:SPAN <freq>

[:SENSe]:AFPanalyzer:SPAN?

Title: Audio Frequency Span

Description: Sets the audio frequency span while in the Audio Spectrum mode (use :AFP:DEM:MODE AFSP to set audio spectrum mode). Valid values are 2 kHz, 5 kHz, 10 kHz, 20 kHz and 70 kHz.

Parameter: <freq>

Default Unit: Hz

Front Panel Access: Shift-4 (Measure), Audio Spectrum, Span

[:SENSe]:AFPanalyzer:SWEep:TIME <time>

[:SENSe]:AFPanalyzer:SWEep:TIME?

Title: Audio Waveform sweep time

Description: Sets the audio waveform sweep time while in the Audio Spectrum mode (use :AFP:DEM:MODE AFSP to set audio spectrum mode).

Parameter: <time>

Default Unit: Secs

Range: 50 μ s to 50 ms.

Front Panel Access: Shift-4 (Measure), Audio Waveform, Sweep Time

[:SENSe]:AFPanalyzer:SUMMARY:DATA?

Title: Summary data

Description: This query returns the measurement values in the Summary view (use :AFP:DEM:MODE SUMM to set summary mode). The order of the values are as follows:

<demod type> (AM|FM|PM), <RMS Deviation> in % or Hz or Rad depending on the demod type, <Peak+ Deviation> in % or Hz or Rad depending on the demod type, <Peak-Dev> in % or Hz or Rad depending on the demod type, <Peak-Peak/2 Dev> in % or Hz or Rad depending on the demod type, <carrier power> in dBm, <carrier freq> in Hz, <Occ BW> in Hz, <Modulation rate> in Hz, <SINAD> in dB, <THD> in % and <Distortion> in %. All values are comma separated.

Front Panel Access: Shift-4 (Measure), Summary.

[:SENSe]:FREQUENCY:CENTer <freq>

[:SENSe]:FREQUENCY:CENTer?

Title: Center Frequency

Description: Sets the center frequency. Note that changing the value of the center frequency may also change the value of the span.

Parameter: <freq>

Default Unit: Hz

Front Panel Access: Freq, Center Freq

[:SENSe]:FREQUENCY:SIGStandard:CHANnel <number>

[:SENSe]:FREQUENCY:SIGStandard:CHANnel?

Title: Channel Selection

Description: Sets the channel number for the selected signal standard.

Parameter: <number>

Front Panel Access: Freq, Channel

[:SENSe]:FREQUENCY:SIGStandard:NAME <string>

[:SENSe]:FREQUENCY:SIGStandard:NAME?

Title: Signal Standard

Description: Selects the desired signal standard from the list. The <string> argument is the name of the desired signal standard as displayed in the instrument's current signal standard list. The list can be displayed on the instrument by choosing the Signal Standard submenu button in the Freq menu. The list can also be downloaded remotely and viewed using Anritsu Master Software Tools. For example, if the desired Signal Standard is:

P-GSM 900 - Uplink then the value of the <string> would be "P-GSM 900 - Uplink".

The query form of this command will return the name of the currently selected Signal Standard on the list.

Parameter: <string>

Front Panel Access: Freq, Signal Standard

[:SENSe]:FREQuency:SPAN <freq>**[:SENSe]:FREQuency:SPAN?**

Title: Frequency Span

Description: Sets the frequency span. Minimum value and the maximum value are 10 kHz and 10 MHz respectively. Note that changing the value of the frequency span may change the Center Frequency.

Parameter: <freq>

Default Unit: Hz

Front Panel Access: Freq, Span

[:SENSe]:FREQuency:SPAN:FULL

Title: Frequency Span – Full

Description: Sets the frequency span to maximum span (10 MHz). Note that changing the value of the frequency span may change the Center Frequency.

Front Panel Access: Freq, Span, Max Span

[:SENSe]:FREQuency:SPAN:MINimum

Title: Frequency Span – Minimum

Description: Sets the frequency span to minimum span (10 kHz). Note that changing the value of the frequency span may change the Center Frequency.

Front Panel Access: Freq, Span, Min Span

[:SENSe]:FREQuency:SPAN:PREVious

Title: Frequency Span – Last

Description: Sets the frequency span to the previous span value. Note that changing the value of the frequency span may change the Center Frequency.

Default Unit: Hz

Front Panel Access: Freq, Span, Last Span

[:SENSe]:FREQuency:STEP[:INCRement] <freq>**[:SENSe]:FREQuency:STEP[:INCRement]?**

Title: Frequency Step

Description: Sets the frequency step to the given frequency value.

Parameter: <freq>

Default Value: 1 MHz

Default Unit: Hz

Range: 1 Hz to 20 GHz

Front Panel Access: Freq, Freq Step

[:SENSE]:OBWidth:METHOD XDB|PERCent

[:SENSE]:OBWidth:METHOD?

Title: Occupied Bandwidth Measurement Method

Description: Sets the method for calculating occupied bandwidth. XDB calculates the occupied bandwidth based on points a specified number of dB below the carrier. Issue command [:SENSE]:OBWidth:XDB to set the number of dB to be used. PERCent calculates the occupied bandwidth based on points a specified percentage of the carrier power below the carrier. Issue command [:SENSE]:OBWidth:PERCent to set the percentage to be used.

Parameter: XDB|PERCent

Parameter Type: <char>

Default Value: PERCent

Related Command: :OBWidth:XDB :OBWidth:PERCent

Front Panel Access: Shift-4 (Measure), RF Spectrum, Occ BW Method

[:SENSE]:OBWidth:PERCent <percentage>

[:SENSE]:OBWidth:PERCent?

Title: Occupied Bandwidth Percent of Power

Description: This command sets the percentage of carrier power used to measure the occupied bandwidth. This value is used in the measurement if :SENSE:OBWidth:METHOD is set to PERCent.

Parameter: <percentage>

Default Value: 99

Default Unit: %

Range: 0% to 100%

Related Command: :OBWidth:METHOD

Front Panel Access: Shift-4 (Measure), RF Spectrum, %

[:SENSe]:OBWidth:XDB <rel ampl>

[:SENSe]:OBWidth:XDB?

Title: Occupied Bandwidth dB Down

Description: This command sets the number of dB below the carrier used to measure the occupied bandwidth. This value is used in the measurement if :SENSe:OBWidth:METhod is set to XDB.

Parameter: <rel ampl>

Default Value: 3 dBc

Default Unit: dBc

Range: 0 to 100 dBc

Related Command: :OBWidth:METhod

Front Panel Access: Shift-4 (Measure), RF Spectrum, dBc

Chapter 15 — Tracking Generator Commands

Note	This chapter is specific to Spectrum Master MS2711E, MS2712E and MS2713E instruments with Option 20.
-------------	--

15-1 :CONFigure Subsystem

This set of commands prepares the instrument for the selected measurement. It disables any currently-enabled measurements and activates the specified measurement. It sets the instrument to single sweep mode, waiting for an :INITiate command. It will not initiate the taking of a measurement.

Current instrument settings may be changed to default values. These changes are identified with their respective measurement commands.

:CONFigure:GENerator:TRACking POWStats|TXStats :CONFigure?

Title: Configure Tracking Generator Measurement

Description: (Only valid for Tracking Mode) This command configures the selected tracking generator power statistic measurement. It disables any other active one-button measurements, including CW, channel power, occupied bandwidth, AM/FM demodulation and C/I.

Sets the tracking generator measurement state to ON.

Sets the instrument to single sweep mode (:INITiate:CONTinuous OFF).

Measurement settings can be modified by using the [:SENSe]:GENerator commands before initiating a sweep.

When the POWStats option is selected, the measurement results are equivalent to the results that are displayed by choosing Shift-4 (Measure), then Generator, then Generator Output On, then Generator Mode Tracking, then Settings, then Power Statistics On. In this mode the :CONF? query would return TRAC,POWS.

When the TXStats option is selected, the Normalize state is set to ON and the measurement results are equivalent to the results that are displayed by choosing Shift-4 (Measure), then Generator, then Generator Output On, then Generator Mode Tracking, then Transmission Measurement, then Normalize On, then Transmission Statistics On. In this mode the :CONF? query would return TRAC,TXS.

Note: :CONFigure:GENerator:TRACking TXStats does not set the instrument to Single Sweep mode. :INIT:CONT OFF sets the instrument in single sweep mode.

Example: To configure power measurements:

```
:CONFigure:GENerator:TRACking POWStats
```

Related Command: :GENerator:OUTput:POWer

```
[ :SENSe: ] :TGENerator:TX [ :SCALe ] :RLEVel
```

```
[ :SENSe: ] :TGENerator:TX [ :SCALe ] :RLEVel:OFFSet
```

```
[ :SENSe: ] :TGENerator:TX [ :SCALe ] :PDIVision
```

Front Panel

Access: Refer to Description section above.

15-2 :FETCh Subsystem

This set of commands returns the most recent measurement data of the active measurement. They will not switch to another measurement.

To make a new measurement, use the INITiate command. To get new measurement data, use the READ or MEASure query commands.

:FETCh:TGENERator:POWStats?

Title: Fetch Tracking Generator Absolute Power Statistics

Description: (Only valid for Tracking Mode) Returns the most recent tracking generator absolute power statistic measurement results displayed in the Tracking Generator Summary table.

Data is returned as 3 comma-separated values: Absolute Max Power, Absolute Min Power, and Absolute Average Power. "---" is returned for each data that is not valid at that instance.

Default Unit: Current amplitude units

Related Command: :CONFigure:GENerator:TRACking POWStats

Front Panel

Access: Shift-4 (Measure), Generator, Settings, Power Statistics

:FETCh:TGENERator:TXStats?

Title: Fetch Tracking Generator Transmission Statistics

Description: (Only valid for Tracking Mode and Normalize On) Returns the most recent tracking generator transmission statistic measurement results.

Data is returned as 3 comma-separated values: Max Power, Min Power, Average Power. "---" is returned for each data that is not valid at that instance.

Default Unit: Current amplitude units

Related Command: :CONFigure:GENerator:TRACking TXStats

Front Panel

Access: Shift-4 (Measure), Generator, Transmission Measurement, Transmission Statistics

15-3 :GENERator Subsystem

This subsystem contains commands related to the generator.

:GENERator:ADDITIONal:CALibration

Title: Perform Additional Calibration

Description: Performs an additional calibration sweep to improve the output of the source. Use [:SENSE:]ENhanced:CALibration:COMplete[:STATe]? to determine when calibration is complete.

Note: This command will work only after the Generator has been turned ON and Enhanced Accuracy Calibration has been turned ON.

Related Command: [:SENSE:]GENERator:ENhanced:CALibration[:STATe] ON
[:SENSE:]MATChing:PADS <num>
[:SENSE:]ENhanced:CALibration:COMplete[:STATe]?

Front Panel

Access: Shift-4 (Measure), Generator, Settings, Enhanced Generator Power Accuracy, Additional Calibration Sweep

:GENERator:OUTput:POWER <amplitude>

:GENERator:OUTput:POWER?

Title: Generator Output Power

Description: Sets the output power for the Generator.

Query returns actual output power setting without regards to any external gain or loss setting.

Note: Returned value will not match displayed output power on the instrument if external gain/loss setting is not 0 dB.

Parameter: <amplitude>

Default Value: -50 dBm

Range: -80 dBm to 15 dBm

Default Unit: Current active amplitude unit

Example: To set the output to -30 dBm when the active amplitude units are dBm:

```
:GENERator:OUTput:POWER -30
```

Related Command: :INITiate:GENERator
:GENERator:OUTput:POWER:OFFSet[:MAGNitude]

Front Panel

Access: Shift-4 (Measure), Generator, Output Power

:GENERATOR:OUTPUT:POWER:OFFSET[:MAGNITUDE] <value>

:GENERATOR:OUTPUT:POWER:OFFSET[:MAGNITUDE]?

Title: Generator Output Power Offset or External Gain/Loss Setting

Description: Sets the output power level offset or the External Gain/Loss Setting. Please note that changing this value will also cause the displayed output power to adjust with the new offset. For example, if the output power is set to -25 dBm and the External Gain/Loss is then set to 10 dB external gain, the power limits will be adjusted by 10 dB and value of the output power displayed on the instrument will be adjusted to -15 dBm. The query returns a value from -100 to 100. A negative sign indicates external loss and no sign indicates external gain.

Parameter: <value>

Default Value: 0 dB

Range: 100 dB Ext Loss to 100 dB Ext Gain

Default Unit: dB

Example: To set the signal generator offset to 10 dB external gain:

:GENERATOR:OUTPUT:POWER:OFFSET 10

Related Command: :GENERATOR:OUTPUT:POWER

Front Panel

Access: Shift-4 (Measure), Generator, Settings, Ext Gain/Loss

15-4 :INITiate Subsystem

This subsystem controls the triggering of measurements.

:INITiate:GENerator OFF|ON|0|1

:INITiate:GENerator?

Title: Generator On/Off

Description: Specifies whether the generator is on or off. If the value is set to ON or 1, the generator is turned on. If the value is set to OFF or 0, the generator is turned off.

The query version of the command returns a 1 if the generator is on and returns a 0 if the generator is off.

Parameter: OFF|ON|0|1

Parameter Type: <boolean>

Default Value: OFF

Example: To turn off generator:

```
:INITiate:GENerator OFF
```

To turn on generator:

```
:INITiate:GENerator ON
```

Related Command: [:SENSe]:GENerator:MODE

Front Panel

Access: Shift-4 (Measure), Generator, Generator Output

15-5 :MEASure Subsystem

These commands take the instrument from its current state, enable the specified measurement and put the instrument into single sweep mode. They correct any parameters that are invalid given the new measurement state such that a valid measurement can take place. Other settings may be changed; see the documentation of CONFigure for each measurement. They then initiate the measurement. When the measurement is complete, they return the result.

To make a measurement with settings other than the “default” measurement settings applied by CONFigure, do the following:

- Send the appropriate CONFigure command to set the desired measurement.
- Modify the settings as required.
- Send the appropriate READ command to measure and return the result.

To get the current measurement data, use the appropriate FETCh command.

:MEASure:TGENerator:POWStats?

Title: Measure Tracking Generator Absolute Statistics

Description: Sets the active measurement to tracking generator with absolute statistics on, sets the default measurement parameters, triggers a new measurement and returns the results.

It is a combination of the commands :CONFigure:GENerator POWStats and :READ:TGENerator:POWStats?

For a description of the default tracking generator absolute statistics measurement parameters, see :CONFigure:GENerator:TRACking.

To make a tracking generator absolute statistics measurement with settings other than the default values, send:

```
:CONFigure:GENerator POWStats
Commands to set desired settings
:READ:TGENerator: POWStats?
```

Data is returned as 3 comma-separated values: Max Power, Min Power, Average Power.

Default Unit: Current amplitude units

Related Command: :CONFigure:GENerator

Front Panel

Access: Shift-4 (Measure), Generator, Settings, Power Statistics

15-6 :READ Subsystem

This set of commands combines the ABORt, INITiate and FETCh commands. It aborts any current triggering sequence and sets the trigger state to idle. It then initiates a new active measurement (i.e. begins the collection of new data). When the measurement is complete, it returns the result. These commands will not switch to another measurement.

To get the current measurement data, use the FETCh command.

:READ:TGENerator:POWStats?

Title: Read Tracking Generator Absolute Statistics

Description: Triggers a new tracking generator absolute statistic measurement and returns the results.

It is a combination of the commands :ABORt; :INITiate;
:FETCh:TGENerator:POWStats?

The tracking generator absolute statistic measurement must be the active measurement (specified by :CONFigure:GENerator POWStats). The current measurement can be queried using :CONFigure?

Data is returned as 3 comma-separated values: absolute max power, absolute min power, absolute average power.

Front Panel

Access: Shift-4 (Measure), Generator, Settings, Power Statistics

:READ:TGENerator:TXStats?

Title: Read Tracking Generator Transmission Statistics

Description: (Only valid for Tracking Mode and Normalize On) Triggers a new tracking generator transmission statistics measurement and returns the results.

It is a combination of the commands :ABORt; :INITiate;
:FETCh:TGENerator:TXStats?

The tracking generator transmission statistic measurement must be the active measurement (specified by :CONFigure:GENerator TXStats). The current measurement can be queried using :CONFigure?

Data is returned as 3 comma-separated values: relative max power, relative min power, relative average power.

Front Panel

Access: Shift-4 (Measure), Generator, Transmission Measurement, Transmission Statistics

15-7 [:SENSE] Subsystem

The commands in this subsystem relate to device-specific parameters, not signal-oriented parameters.

[:SENSE]:CW:FREQUENCY

[:SENSE]:CW:FREQUENCY?

Title: CW Frequency

Description: Sets the frequency for the Generator in CW Mode.

Default Value: 1 GHz

Range: 0 Hz to 3 GHz (MS2711E) or 4 GHz (MS2712E) or 6 GHz (MS2713E)

Default Unit: Hz

Example: To set CW frequency at 2 GHz

:CW:FREQ 2000000000 or :CW:FREQ 2 GHz

Related Command: :INITiate:GENerator, :GENerator MODE CW

Front Panel

Access: Shift-4 (Measure), Generator, Generator Mode CW, CW Frequency

[:SENSE]:GENerator:MODE CW|TRACKing

[:SENSE]:GENerator:MODE?

Title: Generator Mode

Description: Toggle Generator Mode between CW and Tracking.

Note: This command does not turn the generator on. Refer to :INITiate:GENerator

Parameter: CW|TRACKing

Default Value: CW

Example: To select Tracking Generator Mode:

:GEN:MOD TRAC

Related Command: :INITiate:GENerator

Front Panel

Access: Shift-4 (Measure), Generator, Generator Mode

[:SENSe]:GENerator:ENhanced:CALibration[:STATe] OFF|ON|0|1
[:SENSe]:GENerator:ENhanced:CALibration[:STATe]?

Title: Enhanced Accuracy Calibration

Description: Improves the output accuracy of the generator. The calibration can be done in both Tracking Generator and CW Generator modes. Changing the output power turns enhanced calibration OFF. Use [:SENSe]:ENhanced:CALibration:COMPLete[:STATe]? to determine when calibration is complete. Calibration may take 2 to 4 minutes to complete.

Note: The Enhanced Accuracy calibration is eliminated when the calibration is turned off (:GEN:EN:CAL OFF), at Preset, at Power-on, or when the generator output level is changed. The calibrations are not saved nor recalled with Save/Recall.

Parameter: OFF|ON|0|1

Default Value: OFF

Example: To turn Enhanced Accuracy Calibration ON

```
:GENerator:ENhanced:CALibration 1
```

Related Command: :GENERATOR:ADDITIONAL:CALibration

```
[:SENSe]:MATChing:PADS <num>
```

```
[:SENSe]:ENhanced:CALibration:COMPLete[:STATe]?
```

Front Panel

Access: Shift-4 (Measure), Generator, Settings, Enhanced Generator Power Accuracy, Enhanced Accuracy Calibration

[:SENSe]:ENhanced:CALibration:COMPLete[:STATe]?

Title: Calibration Completion State

Description: Queries the state of the enhanced accuracy/additional calibration. This is used with enhanced accuracy calibration and additional calibration to determine the state of the calibration. If 0 is returned, calibration is in progress, -1 indicates failure, 1 indicates completion and 2 indicates failure to start calibration because additional calibration sweep was selected before turning Enhanced Accuracy Calibration ON.

Parameter: 0, -1, 1, 2

Related Command: [:SENSe]:GENerator:ENhanced:CALibration[:STATe]

```
:GENERATOR:ADDITIONAL:CALibration
```

Front Panel

Access: n/a

[:SENSE]:MATCHing:PADS 0|1|2

[:SENSE]:MATCHing:PADS?

Title: Number of External 3 dB Pads

Description: Calibration accuracy can be improved by adding one or two 3 dB pads. This command selects the number of pads added. This is done before turning ON the Enhanced Accuracy Calibration or performing an Additional Calibration Sweep.

Parameter: 0|1|2

Default Value: 2

Range: 0 to 2

Example: If one 3 dB pad is connected on the receiver:

```
:MATCHing:PADS 1
```

Related Command: [:SENSE]:GENerator:ENhanced:CALibration[:STATE] ON
:GENerator:ADDITIONal:CALibration

Front Panel

Access: Shift-4 (Measure), Generator, Settings, Enhanced Generator Power Accuracy, Matching Pads(3dB)

[:SENSE]:TGENerator:POWStats[:STATE] OFF|ON|0|1

[:SENSE]:TGENerator:POWStats[:STATE]?

Title: Tracking Generator Absolute Power Statistic State

Description: Specifies whether the tracking generator absolute power statistic table is ON or OFF. If the value is set to ON or 1, the tracking generator absolute statistic table is turned on. If the value is set to OFF or 0, the tracking generator absolute statistic table is turned off.

The query version of the command returns a 1 if the tracking generator absolute power statistic is on and returns a 0 if the tracking generator power statistic is off.

Note that this command is ignored if the tracking generator output is off.

Parameter: OFF|ON|0|1

Parameter Type: <boolean>

Default Value: OFF

Example: To turn off the generator absolute power statistics:

```
:TGENerator:POWStats OFF
```

Front Panel

Access: Shift-4 (Measure), Generator, Settings, Power Statistics

[:SENSe]:TGENerator:TX:NORMALize[:STATe] OFF|ON|0|1

[:SENSe]:TGENerator:TX:NORMALize[:STATe]?

Title: Tracking Generator Normalize State

Description: (Only valid for Tracking Mode and Normalize On) Specifies whether the tracking generator transmission statistic is ON or OFF. If the value is set to ON or 1, the tracking generator transmission statistic is turned on. Turning on normalization triggers the normalization sweep, during which the sweep complete bit of the operation status is zero, and :STATus:OPERation? can be used to detect the completion of the normalization sweep. If the value is set to OFF or 0, the tracking generator normalization is turned off.

The query version of the command returns a 1 if the tracking generator normalization is on and returns a 0 if the tracking generator normalization is off.

Note that this command is ignored if the tracking generator output is off.

Parameter: OFF|ON|0|1

Parameter Type: <boolean>

Default Value: OFF

Example: To turn off the tracking generator normalized state:

```
:TGENerator:TX:NORMALize OFF
```

Front Panel

Access: Shift-4 (Measure), Generator, Transmission Measurement, Normalize

[:SENSe]:TGENerator:TX[:SCALE]:PDIVision <rel ampl>

[:SENSe]:TGENerator:TX[:SCALE]:PDIVision?

Title: Tracking Generator Scale

Description: (Only valid for Tracking Mode) Sets the tracking generator relative scale (dB/division) in Transmission measurements.

Default Value: 10 dB/div

Range: 1 dB to 15 dB

Default Unit: dB

Related Command: [:SENSe]:TGENerator:TX:NORMALize[:STATe]

Front Panel

Access: Shift-4 (Measure), Generator, Transmission Measurement, Relative Scale

[:SENSE]:TGENERator:TX[:SCALE]:RLEVEL <amplitude>

[:SENSE]:TGENERator:TX[:SCALE]:RLEVEL?

Title: Tracking Generator Reference Level

Description: (Only valid for Tracking Mode) Sets the tracking generator relative reference level amplitude value for the y-axis in Transmission measurements.

Default Value: 10 dB (50 dB after Normalize is turned on)

Default Unit: Current active amplitude unit

Related Command: [:SENSE]:TGENERator:TX[:SCALE]:RLEVEL:OFFSet <rel ampl>

Front Panel

Access: Shift-4 (Measure), Generator, Transmission Measurement, Relative Ref

[:SENSE]:TGENERator:TX[:SCALE]:RLEVEL:OFFSet <rel ampl>

[:SENSE]:TGENERator:TX[:SCALE]:RLEVEL:OFFSet?

Title: (Only valid for Tracking Mode and Normalize On) Tracking Generator Reference Level Offset

Description: Sets the tracking generator reference level offset value for the y-axis in Transmission measurements.

Default Value: 0 dB

Range: -100 dB to 100 dB

Default Unit: dB

Related Command: [:SENSE]:TGENERator:TX:NORMALize[:STATE]
[:SENSE]:TGENERator:TX[:SCALE]:RLEVEL?

Front Panel

Access: Shift-4 (Measure), Generator, Transmission Measurement, Transmission Offset

[:SENSE]:TGENERator:TXStats[:STATE] OFF|ON|0|1

[:SENSE]:TGENERator:TXStats[:STATE]?

Title: Tracking Generator Transmission Statistic State

Description: (Only valid for Tracking Mode and Normalize On) Specifies whether the tracking generator transmission statistic is ON or OFF. If the value is set to ON or 1, the tracking generator transmission statistic is turned on. If the value is set to OFF or 0, the tracking generator transmission statistic is turned off.

The query version of the command returns a 1 if the tracking generator transmission statistic is on and returns a 0 if the tracking generator is off.

Note that this command is ignored if the tracking generator normalization is off.

Parameter: OFF|ON|0|1

Parameter Type: <boolean>

Default Value: OFF

Example: To turn on the tracking generator transmission statistic state:

```
:TGENerator:TXStats ON
```

Related Command: [:SENSe]:TGENerator:TX:NORMALize[:STATE]

Front Panel

Access: Shift-4 (Measure), Generator, Transmission Measurement,
Transmission Statistics

Appendix A — Example

A-1 C/C++

This example is run on the command line. It sends the *IDN? query to the instrument and prints the response to the console.

```
// IdnExample.cpp : Microsoft Visual Studio-Generated Example
//          Based on Example 2-1 in the NI-VISA User Manual
//          Usage : IdnExample
"USB0::0x0B58::0xFFFF9::xxxxxxxx_xxx_xx::INSTR"
//          where xxxxxxxx_xxx_xx is the USB Device ID
of the
//          instrument.
//          Output : The string identity string returned from the
//          instrument.
//          VISA Header : visa.h (must be included)
//          VISA Library : visa32.lib(must be linked with)

#include "stdafx.h"
#include "stdio.h"
#include "string.h"
#include "visa.h"

#define BUFFER_SIZE 255

int main(int argc, char* argv[])
{
    ViStatus status; /* For checking errors */
    ViSession defaultRM, instr; /* Communication channels */
    ViUInt32 retCount; /* Return count from string I/O */
    ViChar buffer[BUFFER_SIZE]; /* Buffer for string I/O */
    char tempDisplay[BUFFER_SIZE]; /* Display buffer for example */
    char *pAddress;

    /* Make sure we got our address. */
    if ( argc < 2 )
    {
        printf("Usage: IdnExample
\"USB0::0x0B58::0xFFFF9::xxxxxxxx_xxx_xx::INSTR");
        printf("\t where xxxxxxxx_xxx_xx is the USB Device ID
of your instrument.\n");
        return -1;
    }
}
```

```

/* Store the address. */
pAddress = argv[1];

/* Begin by initializing the system*/
status = viOpenDefaultRM(&defaultRM);

if (status < VI_SUCCESS)
{
    /* Error Initializing VISA...exiting*/
    printf("Can't initialize VISA\n");
    return -1;
}

/* USB0::0x0B58::0xFFFF9::xxxxxxxx_xxx_xx::INSTR*/
/* NOTE: For simplicity, we will not show error checking*/
/* TODO: Add error handling. */
status = viOpen(defaultRM, pAddress, VI_NULL, VI_NULL,
&instr);

/* Set the timeout for message-based communication*/
/* TODO: Add error handling. */
status = viSetAttribute(instr, VI_ATTR_TMO_VALUE, 120000);

/* Ask the device for identification */
sprintf(buffer, "*IDN?\n");
status = viWrite(instr, (unsigned char *)&buffer[0], 6,
&retCount);
status = viRead(instr, (unsigned char *)buffer, BUFFER_SIZE,
&retCount);

/* TODO: Add code to process data. */
strncpy(tempDisplay, buffer, retCount);
tempDisplay[retCount] = 0; /* Null-terminate display string.
*/
printf("*IDN? Returned %d bytes: %s\n", retCount,
tempDisplay);

/* Close down the system */
/* TODO: Add error handling. */
status = viClose(instr);
status = viClose(defaultRM);

return 0;
}

```

A-2 Visual Basic

This function can be called in a Visual Basic program. It sends the *IDN? query to the instrument and returns the byte count and ASCII response string.

Rem This example is based on Example 2-1 from the NI-VISA User Manual.

```
Public Sub IdnMain(ByVal address As String, ByRef byteCount As String,
ByRef returnBytes As String)
    Const BUFFER_SIZE = 200
    Dim stat As ViStatus
    Dim dfltRM As ViSession
    Dim sesn As ViSession
    Dim retCount As Long
    Dim buffer As String * BUFFER_SIZE

    Rem ***Include visa32.dll as a reference in your project.***

    Rem Begin by initializing the system
    stat = viOpenDefaultRM(dfltRM)
    If (stat < VI_SUCCESS) Then
        Rem Error initializing VISA...exiting
        MsgBox "Can't initialize VISA"
        Exit Sub
    End If

    Rem Open communication with Device
    Rem NOTE: For simplicity, we will not show error checking
    Rem TODO: Add error handling.
    stat = viOpen(dfltRM, address, VI_NULL, VI_NULL, sesn)

    Rem Set the timeout for message-based communication
    Rem TODO: Add error handling.
    stat = viSetAttribute(sesn, VI_ATTR_TMO_VALUE, 120000)

    Rem Ask the device for identification
    Rem TODO: Add error handling.
    stat = viWrite(sesn, "*IDN?", 5, retCount)
    stat = viRead(sesn, buffer, BUFFER_SIZE, retCount)

    Rem TODO: Add code to process the data.
    byteCount = retCount
    returnBytes = Left(buffer, retCount)

    Rem Close down the system
    Rem TODO: Add error handling.
    stat = viClose(sesn)
```

```
stat = viClose(dfltRM)
End Sub
```

A-3 LabVIEW™

This example shows how to read the trace data from the instrument in 32-bit integer format. The output is an array of data point magnitudes. [Figure A-1](#) shows the data capture and conversion to 32-bit integers in the format used by LabVIEW. [Figure A-2](#) shows the details of the conversion.

Note

Your instrument must first be defined to the VISA resource manager using NI-MAX. The VISA resource for your instrument serves as the VISA resource input to the vi.

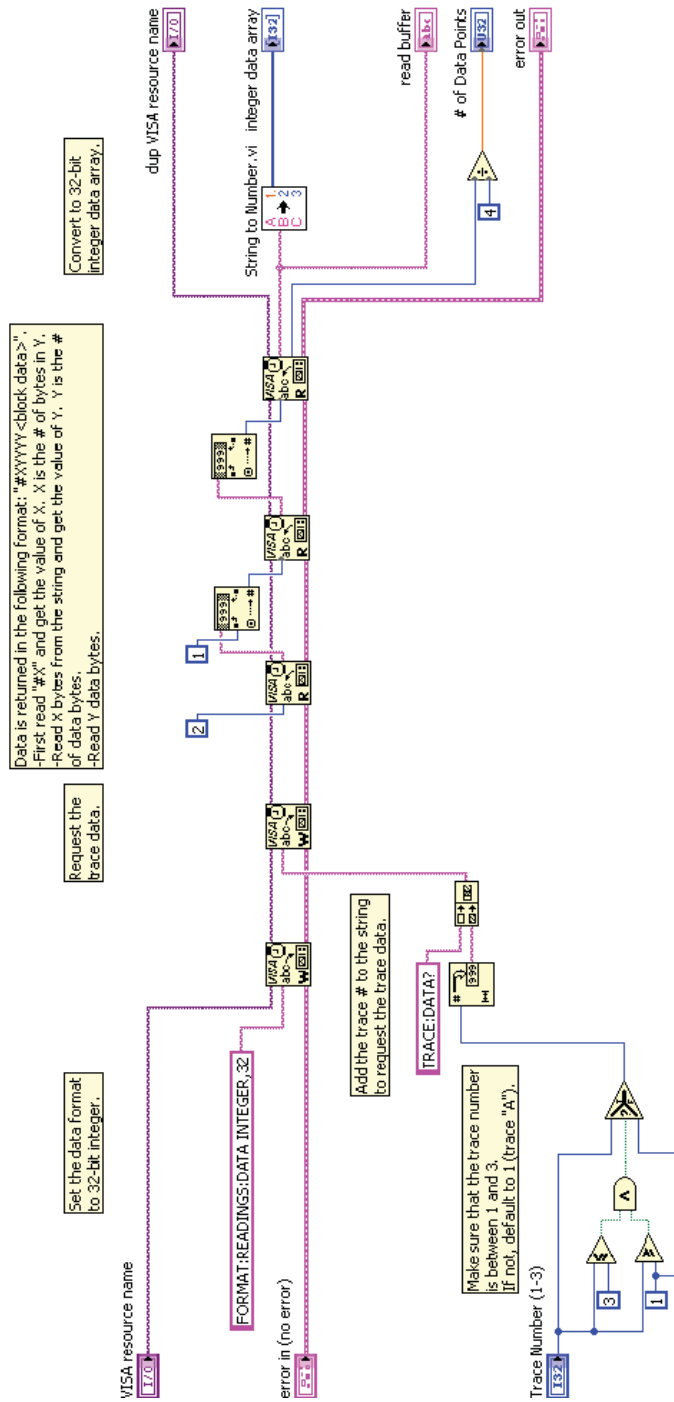

Figure A-1. Data Capture

String To Number.vi

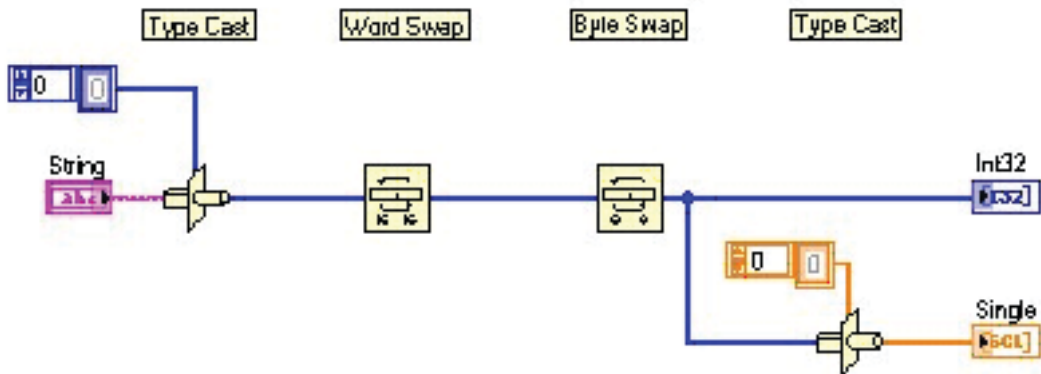

Figure A-2. Data Conversion

Appendix B — List of Commands by Mode

Chapter 1—General Information

Chapter 2—Programming with SCPI

Chapter 3—All Mode Commands

:CONFigure:MEASure?	3-1
:CONFigure:MEASure:1PHase	3-1
:CONFigure:MEASure:ACTiveChan 0 1	
:CONFigure:MEASure:ACTiveChan?	3-1
:CONFigure:MEASure:CABLoss	3-2
:CONFigure:MEASure:DUAldisplay DUAL SINGLE	
:CONFigure:MEASure:DUAldisplay?	3-2
:CONFigure:MEASure:RLDTf	3-2
:CONFigure:MEASure:RLFReq	3-2
:CONFigure:MEASure:SMCHart	3-2
:CONFigure:MEASure:SWRDtf	3-3
:CONFigure:MEASure:SWRFreq	3-3
:FETCh:GPS?	3-3
:INSTrument:CATalog:FULL?	3-5
:INSTrument:NSElect <integer>	
:INSTrument:NSElect?	3-5
:INSTrument[:SElect] <string>	
:INSTrument[:SElect]?	3-6
MMEM:DIR?	3-7
:MMEMory:MSIS INTernal USB	
:MMEMory:MSIS?	3-7
:MMEMory:MSIS:COpy	3-8
:MMEMory:MSIS:DEStination INTernal USB	
:MMEMory:MSIS:DEStination?	3-8
:MMEMory:STORe:JPEG <filename>	3-9
[:SENSe]:GPS ON OFF 1 0	
[:SENSe]:GPS?	3-10
[:SENSe]:GPS:CURRent?	3-10
[:SENSe]:GPS:RESet	3-10
[:SENSe]:GPS:VOLTage 0 1	
[:SENSe]:GPS:VOLTage?	3-10
:STATus:OPERation?	3-11

:SYSTem:MSIS[:STATe]? INTernAl USB	3-12
:SYSTem:OPTions?	3-12
:SYSTem:PRESet	3-12

Chapter 4—Cable & Antenna Commands

:CALCulate:LIMit:ALARm OFF ON 0 1	
:CALCulate:LIMit:ALARm?	4-1
:CALCulate:LIMit:CLEar	4-1
:CALCulate:LIMit:POINt:ADD	4-1
:CALCulate:LIMit:POINt:FREQUency <freq>	
:CALCulate:LIMit:POINt:FREQUency?	4-2
:CALCulate:LIMit:POINt:VALue <value>	
:CALCulate:LIMit:POINt:VALue?	4-2
:CALCulate:LIMit:POINt?	4-2
:CALCulate:LIMit[:STATe] OFF ON 0 1	
:CALCulate:LIMit[:STATe]?	4-3
:CALCulate:MARKer:AOFF	4-3
:CALCulate:MARKer:TABLE:DATA?	4-4
:CALCulate:MARKer:TABLE[:STATe] OFF ON	
:CALCulate:MARKer:TABLE[:STATe]?	4-4
:CALCulate:MARKer{1 2 3 4 5 6}:DELTA:X <x-parameter>	
:CALCulate:MARKer{1 2 3 4 5 6}:DELTA:X?	4-5
:CALCulate:MARKer{1 2 3 4 5 6}:DELTA:Y?	4-5
:CALCulate:MARKer{1 2 3 4 5 6}:DELTA[:STATe] OFF ON 0 1	
:CALCulate:MARKer{1 2 3 4 5 6}:DELTA[:STATe]?	4-5
:CALCulate:MARKer{1 2 3 4 5 6}:PEAK	4-6
:CALCulate:MARKer{1 2 3 4 5 6}:VALley	4-6
:CALCulate:MARKer{1 2 3 4 5 6}:X <x-parameter>	
:CALCulate:MARKer{1 2 3 4 5 6}:X?	4-6
:CALCulate:MARKer{1 2 3 4 5 6}:Y?	4-6
:CALCulate:MARKer{1 2 3 4 5 6}[:STATe] OFF ON 0 1	
:CALCulate:MARKer{1 2 3 4 5 6}[:STATe]?	4-7
:CALCulate:MATH:FUNCTion NORMAl ADD SUBTRACT	
:CALCulate:MATH:FUNCTion?	4-7
:CALCulate:MATH:MEMorize	4-7
:CALCulate:MATH:OVERlay ON OFF	4-8
:CALCulate:SMOothing <integer>	
:CALCulate:SMOothing?	4-8
:CALCulate:TRANSform:CLAVerage?	4-8
:CALCulate:TRANSform:DISTance:CABLoss	
:CALCulate:TRANSform:DISTance:CABLoss?	4-8
:CALCulate:TRANSform:DISTance:DMAX?	4-9

List of Commands by Mode

:CALCulate:TRANSform:DISTance:FRESolution?	4-9
:CALCulate:TRANSform:DISTance:PVELocity	
:CALCulate:TRANSform:DISTance:PVELocity?	4-9
:CALCulate:TRANSform:DISTance:START	
:CALCulate:TRANSform:DISTance:START?	4-9
:CALCulate:TRANSform:DISTance:STOP	
:CALCulate:TRANSform:DISTance:STOP?	4-10
:CALCulate:TRANSform:DISTance:UNIT METers FEET	
:CALCulate:TRANSform:DISTance:UNIT?	4-10
:CALCulate:TRANSform:DISTance:WINDow	
RECTangular MSLobe NSLobe LSLobe	
:CALCulate:TRANSform:DISTance:WINDow?	4-10
:CALibration:STATe?	4-11
:CONFigure:MEASure?	4-12
:CONFigure:MEASure:1PHase.	4-12
:CONFigure:MEASure:ACTiveChan 0 1	
:CONFigure:MEASure:ACTiveChan?	4-12
:CONFigure:MEASure:CABLoss.	4-13
:CONFigure:MEASure:DUALdisplay DUAL SINGLE	
:CONFigure:MEASure:DUALdisplay?	4-13
:CONFigure:MEASure:RLDTf.	4-13
:CONFigure:MEASure:RLFReq	4-13
:CONFigure:MEASure:SMCHart.	4-13
:CONFigure:MEASure:SWRDtf.	4-14
:CONFigure:MEASure:SWRFreq	4-14
:DISPlay:WINDow:TRACe:Y[:SCALe]:AUToscale	4-15
:DISPlay:WINDow:TRACe:Y[:SCALe]:BOTTom <value>	4-15
:DISPlay:WINDow:TRACe:Y[:SCALe]:TOP <value>	4-15
:DISPlay:WINDow:TRACe:Y[:SCALe]:SMCHart 0 10 20 30 -3	
:DISPlay:WINDow:TRACe:Y[:SCALe]:SMCHart?	4-16
:FORMat[:READings][:DATA] ASCii INTeger,32 REAL,32	
:FORMat[:READings][:DATA]?	4-17
:INITiate:CONTInuous OFF ON 0 1	
:INITiate:CONTInuous?	4-20
:INITiate:HOLD OFF ON 0 1	
:INITiate:HOLD?	4-20
:INITiate[:IMMediate].	4-21
:MMEMory:DELeTe <filename>	4-22
:MMEMory:LOAD:STATe <integer>,<filename>	4-22
:MMEMory:LOAD:TRACe <integer>,<filename>	4-23
:MMEMory:STORe:DATA <file name>	4-24

:MMEMory:STORe:STATe <integer>,<filename>	4-24
:MMEMory:STORe:TRACe <integer>,<filename>	4-25
:SOURce:POWer LOW HIGH	
:SOURce:POWer?	4-26
:TRACe:PREamble? [1]	4-27
:TRACe[:DATA]? [1]	4-27
[:SENSe]:AVERAge:CLEar	4-28
[:SENSe]:AVERAge:COUNT <integer>	
[:SENSe]:AVERAge:COUNT?	4-28
[:SENSe]:AVERAge[:STATe] OFF ON 0 1	
[:SENSe]:AVERAge[:STATe]?	4-28
[:SENSe]:CORRection:COLLect:ABORt	4-29
[:SENSe]:CORRection:COLLect:INITialize	4-29
[:SENSe]:CORRection:COLLect:LOAD	4-29
[:SENSe]:CORRection:COLLect:OPEN	4-30
[:SENSe]:CORRection:COLLect:SHORt	4-30
[:SENSe]:CORRection:COLLect:STATus? [INITialize OPEN SHORt LOAD].	4-31
[:SENSe]:CORRection:INSTacal:CALibrate	4-31
[:SENSe]:CORRection:TYPE STANDARD FLEX	
[:SENSe]:CORRection:TYPE?	4-31
[:SENSe]:FREQuency:CABLe <index>	4-32
[:SENSe]:FREQuency:LINK UPLINK DOWNLINK UPANDDOWNLINK	
[:SENSe]:FREQuency:LINK?	4-32
[:SENSe]:FREQuency:SIGStandard:NAME <string>	
[:SENSe]:FREQuency:SIGStandard:NAME?	4-32
[:SENSe]:FREQuency:STARt <freq>	
[:SENSe]:FREQuency:STARt?	4-33
[:SENSe]:FREQuency:STOP <freq>	
[:SENSe]:FREQuency:STOP?	4-33
[:SENSe]:SWEep:RESolution LOW MEDIum HIGH 1102 2204	
[:SENSe]:SWEep:RESolution?	4-34
[:SENSe]:SWEep:RFIMmunity 0 1	
[:SENSe]:SWEep:RFIMmunity?	4-34

Chapter 5—Spectrum Analyzer Commands

:ABORt	5-1
:CALCulate:LIMit:ALARm OFF ON 0 1	
:CALCulate:LIMit:ALARm?	5-2
:CALCulate:LIMit:CENter	5-2
:CALCulate:LIMit:ENvelope:CREate	5-3
:CALCulate:LIMit:ENvelope:OFFSet <amplitude>	

List of Commands by Mode

:CALCulate:LIMit:ENVELOpe:OFFSet?	5-3
:CALCulate:LIMit:ENVELOpe:POINt <number>	
:CALCulate:LIMit:ENVELOpe:POINt?	5-4
:CALCulate:LIMit:ENVELOpe:SHAPE SQUare SLOPe	
:CALCulate:LIMit:ENVELOpe:SHAPE?	5-4
:CALCulate:LIMit:ENVELOpe:UPDate:Y	5-4
:CALCulate:LIMit:FAIL?	5-5
:CALCulate:LIMit:LOWer:ALARm OFF ON 0 1	
:CALCulate:LIMit:LOWer:ALARm?	5-5
:CALCulate:LIMit:LOWer:FAIL?	5-5
:CALCulate:LIMit:LOWer:POINt?	5-5
:CALCulate:LIMit:LOWer[:STATe] OFF ON 0 1	
:CALCulate:LIMit:LOWer[:STATe]?	5-6
:CALCulate:LIMit:LTYPe ABSolute RELative	
:CALCulate:LIMit:LTYPe?	5-6
:CALCulate:LIMit:MIRRor	5-7
:CALCulate:LIMit:POINt:ADD	5-7
:CALCulate:LIMit:POINt:DELete	5-7
:CALCulate:LIMit:POINt:LEFT	5-7
:CALCulate:LIMit:POINt:RIGHT	5-8
:CALCulate:LIMit:POINt:X <x-parameter>	
:CALCulate:LIMit:POINt:X?	5-8
:CALCulate:LIMit:POINt:Y <y-parameter>	
:CALCulate:LIMit:POINt:Y?	5-9
:CALCulate:LIMit:POINt?	5-9
:CALCulate:LIMit:TYPe 0 1	
:CALCulate:LIMit:TYPe?	5-9
:CALCulate:LIMit:UPPer:ALARm OFF ON 0 1	
:CALCulate:LIMit:UPPer:ALARm?	5-10
:CALCulate:LIMit:UPPer:FAIL?	5-10
:CALCulate:LIMit:UPPer:POINt?	5-10
:CALCulate:LIMit:UPPer[:STATe] OFF ON 0 1	
:CALCulate:LIMit:UPPer[:STATe]?	5-11
:CALCulate:LIMit:VALue <value>	5-11
:CALCulate:LIMit:VERTical:ADD	5-12
:CALCulate:LIMit:X <x-parameter>	5-12
:CALCulate:LIMit:Y <y-parameter>	5-12
:CALCulate:LIMit[:SET]:DEFault	5-13
:CALCulate:LIMit[:STATe] OFF ON 0 1	

:CALCulate:LIMit[:STATe]?	5-13
:CALCulate:MARKer:AOff	5-14
:CALCulate:MARKer:PEAK:THReshold <percentage>	
:CALCulate:MARKer:PEAK:THReshold?	5-14
:CALCulate:MARKer:TABLE[:STATe] OFF ON	
:CALCulate:MARKer:TABLE[:STATe]?	5-14
:CALCulate:MARKer{1 2 3 4 5 6}:DELTA:NOISe[:STATe] OFF ON 0 1	
:CALCulate:MARKer{1 2 3 4 5 6}:DELTA:NOISe[:STATe]?	5-15
:CALCulate:MARKer{1 2 3 4 5 6}:DELTA:X <x-parameter>	
:CALCulate:MARKer{1 2 3 4 5 6}:DELTA:X?	5-15
:CALCulate:MARKer{1 2 3 4 5 6}:DELTA:Y?	5-16
:CALCulate:MARKer{1 2 3 4 5 6}:DELTA[:SET]:SPAN	5-16
:CALCulate:MARKer{1 2 3 4 5 6}:DELTA[:STATe] OFF ON 0 1	
:CALCulate:MARKer{1 2 3 4 5 6}:DELTA[:STATe]?	5-16
:CALCulate:MARKer{1 2 3 4 5 6}:FCOunt[:STATe] OFF ON 0 1	
:CALCulate:MARKer{1 2 3 4 5 6}:FCOunt[:STATe]?	5-17
:CALCulate:MARKer{1 2 3 4 5 6}:FIXed[:STATe] OFF ON 0 1	
:CALCulate:MARKer{1 2 3 4 5 6}:FIXed[:STATe]?	5-17
:CALCulate:MARKer{1 2 3 4 5 6}:MAXimum	5-18
:CALCulate:MARKer{1 2 3 4 5 6}:MAXimum:LEFT	5-18
:CALCulate:MARKer{1 2 3 4 5 6}:MAXimum:NEXT	5-18
:CALCulate:MARKer{1 2 3 4 5 6}:MAXimum:RIGHT	5-18
:CALCulate:MARKer{1 2 3 4 5 6}:NOISe[:STATe] OFF ON 0 1	
:CALCulate:MARKer{1 2 3 4 5 6}:NOISe[:STATe]?	5-19
:CALCulate:MARKer{1 2 3 4 5 6}:X <x-parameter>	
:CALCulate:MARKer{1 2 3 4 5 6}:X?	5-20
:CALCulate:MARKer{1 2 3 4 5 6}:Y?	5-20
:CALCulate:MARKer{1 2 3 4 5 6}[:SET]:CENTer	5-21
:CALCulate:MARKer{1 2 3 4 5 6}[:SET]:RLEVel	5-21
:CALCulate:MARKer{1 2 3 4 5 6}[:STATe] OFF ON 0 1	
:CALCulate:MARKer{1 2 3 4 5 6}[:STATe]?	5-21
:CONFigure:ACPower	5-22
:CONFigure:CHPower	5-22
:CONFigure:FSTRength	5-23
:CONFigure:OBWidth	5-23
:DISPlay:WINDow:TRACe:Y:ADJust	5-24
:DISPlay:WINDow:TRACe:Y[:SCALE]:PDIVision <rel ampl>	
:DISPlay:WINDow:TRACe:Y[:SCALE]:PDIVision?	5-24
:DISPlay:WINDow:TRACe:Y[:SCALE]:RLEVel <amplitude>	

List of Commands by Mode

:DISPlay:WINDow:TRACe:Y[:SCALe]:RLEVel?	5-24
:DISPlay:WINDow:TRACe:Y[:SCALe]:RLEVel:OFFSet <rel ampl>	
:DISPlay:WINDow:TRACe:Y[:SCALe]:RLEVel:OFFSet?	5-25
:DISPlay[:WINDow]:TRACe:Y[:SCALe]:RLEVel:AUTO IMMEDIATE	5-25
:FETCh:ACPower?	5-26
:FETCh:CHPower:CHPower?	5-26
:FETCh:CHPower:DENSity?	5-26
:FETCh:CHPower?	5-27
:FETCh:OBWidth:FREQUency?	5-27
:FETCh:OBWidth?	5-27
:FORMat[:READings][:DATA] ASCii INTeger,32 REAL,[<length>]	
:FORMat[:READings][:DATA]?	5-28
:INITiate:CONTinuous OFF ON 0 1	
:INITiate:CONTinuous?	5-29
:INITiate[:IMMEDIATE].	5-29
:INITiate:SAVe:ON:EVENT:CROSSsing:LIMit OFF ON 0 1	5-30
:INITiate:SAVe:ON:EVENT:SWEep OFF ON 0 1	5-30
:INITiate:SAVe:THEn:STOp OFF ON 0 1	5-30
:MEASure:ACPower?	5-31
:MEASure:CHPower:CHPower?	5-31
:MEASure:CHPower:DENSity?	5-32
:MEASure:CHPower?	5-32
:MEASure:OBWidth?	5-33
:MMEMory:DATA? <filename>	5-34
:MMEMory:DELeTe <filename>	5-34
:MMEMory:LOAD:LIMit <filename>	5-34
:MMEMory:LOAD:STATe <integer>,<filename>	5-35
:MMEMory:LOAD:TRACe <integer>,<filename>	5-36
:MMEMory:STORe:LIMit <filename>	5-37
:MMEMory:STORe:STATe <integer>,<filename>	5-37
:MMEMory:STORe:TRACe <integer>,<filename>	5-37
:READ:ACPower?	5-38
:READ:CHPower:DENSity?	5-38
:READ:CHPower?	5-38
:READ:OBWidth?	5-39
:TRACe:COPY TRACE1,TRACE2 TRACE3	5-40
:TRACe:EXCHange TRACE2,TRACE3	5-40

:TRACe:PREamble? {1 2 3}	5-41
:TRACe[:DATA] {1 2 3},(<header><block>)	
:TRACe[:DATA]? {1 2 3}	5-41
:TRACe{1 2 3}:DISPlay[:STATe] OFF ON 0 1	
:TRACe{1 2 3}:DISPlay[:STATe]?	5-42
:TRACe{1 2 3}:LOAD:DISPlay[:STATe] OFF ON 0 1	
:TRACe{1 2 3}:LOAD:DISPlay[:STATe]?	5-43
:TRACe{1 2 3}:WRITe[:STATe] OFF ON 0 1	
:TRACe{1 2 3}:WRITe[:STATe]?	5-43
:TRACe1:OPERation NORMal MAXHold MINHold AVERage	
:TRACe1:OPERation?	5-44
:TRACe2:OPERation MAXHold MINHold	
:TRACe2:OPERation?	5-44
:TRACe3:OPERation MAXHold MINHold A-B B-A	
:TRACe3:OPERation?	5-45
:TRIGger[:SEQuence]:SOURce IMMEDIATE EXTernal VIDeo	
:TRIGger[:SEQuence]:SOURce?	5-46
:TRIGger[:SEQuence]:VIDeo:LEVel <amplitude>	
:TRIGger[:SEQuence]:VIDeo:LEVel?	5-46
:TRIGger[:SEQuence]:VIDeo:DELay <percentage> or <time>	
:TRIGger[:SEQuence]:VIDeo:DELay?	5-47
:UNIT:POWer DBM DBV DBMV DBUV V W DBW A DBA WCM2	
:UNIT:POWer?	5-48
[:SENSe]:ACPowEr:BANDwidth BWIDth:ADJacent <freq>	
[:SENSe]:ACPowEr:BANDwidth BWIDth:ADJacent?	5-49
[:SENSe]:ACPowEr:BANDwidth BWIDth:MAIN <freq>	
[:SENSe]:ACPowEr:BANDwidth BWIDth:MAIN?	5-49
[:SENSe]:ACPowEr:BANDwidth BWIDth:SPACing <freq>	
[:SENSe]:ACPowEr:BANDwidth BWIDth:SPACing?	5-49
[:SENSe]:ACPowEr:STATe OFF ON 0 1	
[:SENSe]:ACPowEr:STATe?	5-50
[:SENSe]:AVERage:COUNt <integer>	
[:SENSe]:AVERage:COUNt?	5-50
[:SENSe]:AVERage:TYPE NONE SCALar MAXimum MINimum	
[:SENSe]:AVERage:TYPE?	5-51
[:SENSe]:BANDwidth BWIDth:VIDeo <freq>	
[:SENSe]:BANDwidth BWIDth:VIDeo?	5-51
[:SENSe]:BANDwidth BWIDth:VIDeo:AUTO OFF ON 0 1	
[:SENSe]:BANDwidth BWIDth:VIDeo:AUTO?	5-52
[:SENSe]:BANDwidth BWIDth:VIDeo:RATio <number>	
[:SENSe]:BANDwidth BWIDth:VIDeo:RATio?	5-52
[:SENSe]:BANDwidth BWIDth[:RESolution] <freq>	

List of Commands by Mode

[[:SENSe]:BANDwidth BWIDth[:RESolution]?	5-53
[[:SENSe]:BANDwidth BWIDth[:RESolution]:AUTO OFF ON 0 1 [[:SENSe]:BANDwidth BWIDth[:RESolution]:AUTO?	5-53
[[:SENSe]:BANDwidth BWIDth[:RESolution]:RATio <number> [[:SENSe]:BANDwidth BWIDth[:RESolution]:RATio?	5-54
[[:SENSe]:CHPower:BANDwidth BWIDth:INTegration <freq> [[:SENSe]:CHPower:BANDwidth BWIDth:INTegration?	5-54
[[:SENSe]:CHPower:STATe OFF ON 0 1 [[:SENSe]:CHPower:STATe?	5-54
[[:SENSe]:CORRection:IMPedance[:INPut]:OFFSet <rel ampl> [[:SENSe]:CORRection:IMPedance[:INPut]:OFFSet?	5-55
[[:SENSe]:CORRection:IMPedance[:INPut][:MAGNitude] <integer> [[:SENSe]:CORRection:IMPedance[:INPut][:MAGNitude]?	5-55
[[:SENSe]:DETector[:FUNction] POSitive RMS NEGative SAMPLE [[:SENSe]:DETector[:FUNction]?	5-56
[[:SENSe]:EMF:STATe OFF ON 0 1 [[:SENSe]:EMF:STATe?	5-56
[[:SENSe]:EXTRefstatus?	5-56
[[:SENSe]:FREQuency:CENTer <freq> [[:SENSe]:FREQuency:CENTer?	5-57
[[:SENSe]:FREQuency:SIGStandard:CHANnel <number> [[:SENSe]:FREQuency:SIGStandard:CHANnel?	5-57
[[:SENSe]:FREQuency:SIGStandard:NAMe <string> [[:SENSe]:FREQuency:SIGStandard:NAMe?	5-57
[[:SENSe]:FREQuency:SPAN <freq> [[:SENSe]:FREQuency:SPAN?	5-58
[[:SENSe]:FREQuency:SPAN:FULL	5-58
[[:SENSe]:FREQuency:SPAN:PREVious	5-58
[[:SENSe]:FREQuency:START <freq> [[:SENSe]:FREQuency:START?	5-58
[[:SENSe]:FREQuency:STEP[:INCRement] <freq> [[:SENSe]:FREQuency:STEP[:INCRement]?	5-59
[[:SENSe]:FREQuency:STOP <freq> [[:SENSe]:FREQuency:STOP?	5-59
[[:SENSe]:FSTRength:ANTenna <antenna> [[:SENSe]:FSTRength:ANTenna?	5-59
[[:SENSe]:FSTRength:STATe OFF ON 0 1 [[:SENSe]:FSTRength:STATe?	5-60
[[:SENSe]:OBWidth:METHod XDB PERCent [[:SENSe]:OBWidth:METHod?	5-60
[[:SENSe]:OBWidth:PERCent <percentage>	

[:SENSe]:OBWidth:PERCent?	5-61
[:SENSe]:OBWidth:STATe OFF ON 0 1	
[:SENSe]:OBWidth:STATe?	5-61
[:SENSe]:OBWidth:XDB <rel ampl>	
[:SENSe]:OBWidth:XDB?	5-61
[:SENSe]:OPTion:IF:BWStAt 1 2 3 4 5	
[:SENSe]:OPTion:IF:BWStAt?	5-62
[:SENSe]:POWer[:RF]:ATTenuation <rel ampl>	
[:SENSe]:POWer[:RF]:ATTenuation?	5-62
[:SENSe]:POWer[:RF]:ATTenuation:AUTO OFF ON 0 1	
[:SENSe]:POWer[:RF]:ATTenuation:AUTO?	5-63
[:SENSe]:POWer[:RF]:GAIN[:STATe] OFF ON 0 1	
[:SENSe]:POWer[:RF]:GAIN[:STATe]?	5-64
[:SENSe]:SWEep:MODE FAST PERFormance NOFFt	
[:SENSe]:SWEep:MODE?	5-64
[:SENSe]:SWEep:STATus?	5-64
[:SENSe]:SWEep:TIME[:LLIMit]	
[:SENSe]:SWEep:TIME[:LLIMit]?	5-65
[:SENSe]:SWEep:TIME:ACTual?	5-65
[:SENSe]:SWEep:TIME:AUTO ON OFF 1 0	
[:SENSe]:SWEep:TIME:AUTO?	5-65
[:SENSe]:SWEep:TRACe?	5-65

Chapter 6—GSM Commands

:ABORt	6-1
:CONFigure:SUMMary	6-2
:CONFigure:DEMod	6-2
:CONFigure:PFail	6-3
:CONFigure:PVTFrame	6-3
:CONFigure:PVTSlot	6-4
:CONFigure:SPECtrum:MULTi	6-4
:CONFigure:SPECtrum:SINGLE	6-4
:CONFigure?	6-5
:DISPlay:WINDow:TRACe:Y[:SCALe]:OFFSet <rel ampl>	
:DISPlay:WINDow:TRACe:Y[:SCALe]:OFFSet?	6-6
:FETCh:DEMod?	6-7
:FETCh:PFail?	6-7
:FETCh:PVTFrame?	6-8
:FETCh:PVTSlot?	6-8
:FETCh:SPECtrum:MULTi?	6-9

List of Commands by Mode

:FETCh:SPECtrum:SINGle?	6-9
:FORMat[:READings][:DATA] ASCii INTeger,32 REAL,32	
:FORMat[:READings][:DATA]?	6-10
:INITiate:CONTInuous OFF ON 0 1	
:INITiate:CONTInuous?	6-11
:INITiate[:IMMediate].	6-11
:MEASure:DEMod?	6-12
:MEASure:PFail?	6-13
:MEASure:PVTFrame?	6-13
:MEASure:PVTSlot?	6-14
:MEASure:SPECtrum:MULTi?	6-15
:MEASure:SPECtrum:SINGle?	6-15
:MMEMory:DELeTe <filename>	6-16
:MMEMory:LOAD:TRACe <integer>,<filename>	6-17
:MMEMory:LOAD:STATe <integer>,<filename>	6-18
:MMEMory:STORE:STATe <integer>,<filename>	6-18
:MMEMory:STORE:TRACe <integer>,<filename>	6-18
:READ:DEMod?	6-20
:READ:PFail?	6-20
:READ:PVTFrame?	6-21
:READ:PVTSlot?	6-21
:READ:SPECtrum:MULTi?	6-22
:READ:SPECtrum:SINGle?	6-22
:TRACe:PREamble? <trace type>	6-23
:TRACe[:DATA]? <trace type>	6-23
[:SENSe]:FREQuency:BAND AUTO GSM EDGE	
[:SENSe]:FREQuency:BAND?	6-24
[:SENSe]:FREQuency:CENTer <freq>	
[:SENSe]:FREQuency:CENTer?	6-24
[:SENSe]:FREQuency:SIGStandard:CHANnel <number>	
[:SENSe]:FREQuency:SIGStandard:CHANnel?	6-24
[:SENSe]:FREQuency:SIGStandard:NAME <string>	
[:SENSe]:FREQuency:SIGStandard:NAME?	6-25
[:SENSe]:FREQuency:STARt?	6-25
[:SENSe]:FREQuency:STOP?	6-25
[:SENSe]:PFail <test set>	
[:SENSe]:PFail?	6-26
[:SENSe]:POWER[:RF]:RANGe:AUTO OFF ON 0 1	
[:SENSe]:POWER[:RF]:RANGe:AUTO?	6-26
[:SENSe]:POWER[:RF]:RANGe[:IMMediate]	6-27

[:SENSe]:PVTFrame:START?	6-27
[:SENSe]:PVTFrame:STOP?	6-27
[:SENSe]:PVTSlot:START?	6-27
[:SENSe]:PVTSlot:STOP?	6-27

Chapter 7—WCDMA Commands

:ABORt	7-1
:CALCulate:MARKer:AOff	7-2
:CALCulate:MARKer{1 2 3 4 5 6}:X <x-parameter> :CALCulate:MARKer{1 2 3 4 5 6}:X?	7-2
:CALCulate:MARKer{1 2 3 4 5 6}:Y?	7-2
:CALCulate:MARKer{1 2 3 4 5 6}[:STATe] OFF ON 0 1 :CALCulate:MARKer{1 2 3 4 5 6}[:STATe]?	7-3
:CONFigure SUMMary PFail	7-4
:CONFigure:DEMod <char>	7-4
:CONFigure:OTA	7-5
:CONFigure:RF <char>	7-5
:DISPlay:WINDow:TRACe:Y[:SCALe]:OFFSet <rel ampl> :DISPlay:WINDow:TRACe:Y[:SCALe]:OFFSet?	7-7
:DISPlay:WINDow:TRACe:Y[:SCALe]:PDIVision <rel ampl> :DISPlay:WINDow:TRACe:Y[:SCALe]:PDIVision?	7-7
:FETCh:ACL?	7-8
:FETCh:CHPower?	7-8
:FETCh:DEMod:ACTChannels?	7-9
:FETCh:DEMod:CDPower?	7-10
:FETCh:DEMod:CFTThrough?	7-10
:FETCh:DEMod:EVM?	7-10
:FETCh:DEMod:FERRor:PPM?	7-11
:FETCh:DEMod:FERRor:PRECise?	7-11
:FETCh:DEMod:FERRor?	7-11
:FETCh:DEMod:HSDPa:FERRor:PPM?	7-12
:FETCh:DEMod:HSDPa:FERRor?	7-12
:FETCh:DEMod:HSDPa:TXFRequency?	7-12
:FETCh:DEMod:NFLoor?	7-13
:FETCh:DEMod:NUMChannels?	7-13
:FETCh:DEMod:SPOWer?	7-13
:FETCh:DEMod:TXFRequency:PRECise?	7-14
:FETCh:DEMod:TXFRequency?	7-14

List of Commands by Mode

:FETCh:EMISsion:FAIL?	7-14
:FETCh:EMISsion:TEMPlate:DATA?	7-15
:FETCh:EMISsion:TEMPlate?	7-15
:FETCh:EMISsion?	7-16
:FETCh:OBWidth?	7-16
:FETCh:OTA{1 2 3 4 5 6}?	7-16
:FETCh:PFail?	7-17
:FETCh:PTAPower?	7-17
:FORMat[:READings][:DATA] ASCii INTeger,32 REAL,32	
:FORMat[:READings][:DATA]?	7-18
:INITiate:CONTInuous OFF ON 0 1	
:INITiate:CONTInuous?	7-19
:INITiate[:IMMediate].	7-19
:MEASure:ACLR?	7-20
:MEASure:CHPower?	7-20
:MEASure:DEMod:ACTChannels?	7-21
:MEASure:DEMod:CDPower?	7-21
:MEASure:DEMod:CFTHrough?	7-22
:MEASure:DEMod:EVM?	7-22
:MEASure:DEMod:FERRor:PPM?	7-22
:MEASure:DEMod:FERRor:PRECise?	7-23
:MEASure:DEMod:FERRor?	7-23
:MEASure:DEMod:HSDPa:FERRor:PPM?	7-24
:MEASure:DEMod:HSDPa:FERRor?	7-24
:MEASure:DEMod:HSDPa:TXFRequency?	7-24
:MEASure:DEMod:NFLoor?	7-25
:MEASure:DEMod:NUMChannels?	7-25
:MEASure:DEMod:SPOWER?	7-26
:MEASure:DEMod:TXFRequency:PRECise?	7-26
:MEASure:DEMod:TXFRequency?	7-27
:MEASure:EMISsion:FAIL?	7-27
:MEASure:EMISsion:TEMPlate:DATA?	7-27
:MEASure:EMISsion:TEMPlate?	7-28
:MEASure:EMISsion?	7-28
:MEASure:OBWidth?	7-29
:MEASure:OTA{1 2 3 4 5 6}?	7-30

:MEASure:PFail?	7-30
:MEASure:PTAPower?	7-31
:MMEMory:DELeTe <filename>	7-32
:MMEMory:LOAD:STATe <integer>,<filename>	7-32
:MMEMory:LOAD:TRACe <integer>,<filename>	7-32
:MMEMory:STORe:PFail <header><block>	7-33
:MMEMory:STORe:STATe <integer>,<filename>	7-34
:MMEMory:STORe:TRACe <integer>,<filename>	7-34
:READ:ACLR?	7-35
:READ:CHPower?	7-35
:READ:DEMod:ACTChannels?	7-36
:READ:DEMod:CDPower?	7-36
:READ:DEMod:CFTHrough?	7-36
:READ:DEMod:EVM?	7-37
:READ:DEMod:FERRor:PPM?	7-37
:READ:DEMod:FERRor:PRECise?	7-37
:READ:DEMod:FERRor?	7-37
:READ:DEMod:HSDPa:FERRor:PPM?	7-38
:READ:DEMod:HSDPa:FERRor?	7-38
:READ:DEMod:HSDPa:TXFRequency?	7-38
:READ:DEMod:NFLoor?	7-38
:READ:DEMod:NUMChannels?	7-39
:READ:DEMod:SPOWer?	7-39
:READ:DEMod:TXFRequency:PRECise?	7-39
:READ:DEMod:TXFRequency?	7-40
:READ:EMISsion:FAIL?	7-40
:READ:EMISsion:TEMPlate:DATA?	7-40
:READ:EMISsion:TEMPlate?	7-40
:READ:EMISsion?	7-41
:READ:OBWidth?	7-41
:READ:OTA{1 2 3 4 5 6}?	7-41
:READ:PFail?	7-42
:READ:PTAPower?	7-42
:TRACe:PREamble? <trace type>	7-43
:TRACe[:DATA] ACLR SPECTrum EMISsion DEMod,<header><block>)	
:TRACe[:DATA]? ACLR SPECTrum EMISsion DEMod	7-43

List of Commands by Mode

[.SENSE]:AVERAge:FERRor OFF ON 0 1	
[.SENSE]:AVERAge:FERRor?	7-45
[.SENSE]:AVERAge:FERRor:COUNT <integer>	
[.SENSE]:AVERAge:FERRor:COUNT?	7-45
[.SENSE]:DEMod:CODogram:TIME <seconds>	
[.SENSE]:DEMod:CODogram:TIME?	7-46
[.SENSE]:DEMod:CPICH:ABSolute?	7-46
[.SENSE]:DEMod:CPICH:RELative?	7-46
[.SENSE]:DEMod:CTRLchannels:UNIT RELative ABSolute DELTA	
[.SENSE]:DEMod:CTRLchannels:UNIT?	7-46
[.SENSE]:DEMod:HSDPa:IQPersistence <integer>	
[.SENSE]:DEMod:HSDPa:IQPersistence?	7-47
[.SENSE]:DEMod:HSDPa:TIME <seconds>	
[.SENSE]:DEMod:HSDPa:TIME?	7-47
[.SENSE]:DEMod:PCCPch:RELative?	7-47
[.SENSE]:DEMod:PCDerror?	7-47
[.SENSE]:DEMod:PICH:CODE <code number>	
[.SENSE]:DEMod:PICH:CODE?	7-48
[.SENSE]:DEMod:SCCPch:CODE <code number>	
[.SENSE]:DEMod:SCCPch:CODE?	7-48
[.SENSE]:DEMod:SCCPch:SFACTOR 4 8 16 32 64 128 256	
[.SENSE]:DEMod:SCCPch:SFACTOR?	7-48
[.SENSE]:DEMod:SCODE <scrambling code>	
[.SENSE]:DEMod:SCODE?	7-49
[.SENSE]:DEMod:SCODE:AUTO OFF ON 0 1	
[.SENSE]:DEMod:SCODE:AUTO?	7-49
[.SENSE]:DEMod:SFACTOR 256 512	
[.SENSE]:DEMod:SFACTOR?	7-49
[.SENSE]:DEMod:THRShold <rel ampl>	
[.SENSE]:DEMod:THRShold?	7-50
[.SENSE]:DEMod:THRShold:AUTO OFF ON 0 1	
[.SENSE]:DEMod:THRShold:AUTO?	7-50
[.SENSE]:FREQuency:CENTer <freq>	
[.SENSE]:FREQuency:CENTer?	7-50
[.SENSE]:FREQuency:SIGStandard:CHANnel <number>	
[.SENSE]:FREQuency:SIGStandard:CHANnel?	7-51
[.SENSE]:FREQuency:SIGStandard:NAMe <string>	
[.SENSE]:FREQuency:SIGStandard:NAMe?	7-51
[.SENSE]:FREQuency:START?	7-51
[.SENSE]:FREQuency:STOP?	7-51
[.SENSE]:OTA:RESet	7-52

[:SENSe]:OTA:SCODE:AUTO OFF ON 0 1	
[:SENSe]:OTA:SCODE:AUTO?	7-52
[:SENSe]:OTA:SCODE:LOCK OFF ON 0 1	
[:SENSe]:OTA:SCODE:LOCK?	7-53
[:SENSe]:OTA:SCODE{1 2 3 4 5 6}<scrambling code>	
[:SENSe]:OTA:SCODE{1 2 3 4 5 6}?	7-53
[:SENSe]:OTA:SORT CODE POWER	
[:SENSe]:OTA:SORT?	7-54
[:SENSe]:PFail <test set>	
[:SENSe]:PFail?	7-54
[:SENSe]:POWER[:RF]:RANGe:AUTO OFF ON 0 1	
[:SENSe]:POWER[:RF]:RANGe:AUTO?	7-55
[:SENSe]:POWER[:RF]:RANGe[:IMMEDIATE]	7-55
[:SENSe]:RF:ACLR:ADJCchannelcount <num of channels>	
[:SENSe]:RF:ACLR:ADJCchannelcount?	7-55
[:SENSe]:RF:ACLR:MAINchannelcount <num of main channels>	
[:SENSe]:RF:ACLR:MAINchannelcount?	7-56

Chapter 8—TDSCDMA Commands

:ABORT	8-1
:CONFigure SUMMary PFail	8-2
:CONFigure:DEMod <char>	8-2
:CONFigure:OTA	8-3
:CONFigure:RF <char>	8-3
:DISPlay:WINDow:TRACe:Y[:SCALe]:OFFSet <rel ampl>	
:DISPlay:WINDow:TRACe:Y[:SCALe]:OFFSet?	8-4
:DISPlay:WINDow:TRACe:Y[:SCALe]:PDIVision <rel ampl>	
:DISPlay:WINDow:TRACe:Y[:SCALe]:PDIVision?	8-4
:FETCh:DEMod:CDPData?	8-5
:FETCh:OTA?	8-5
:FETCh:RF:EMISsion?	8-6
:FETCh:RF:SPECTrum?	8-6
:FORMat[:READings][:DATA] ASCii INTEger,32 REAL,32	
:FORMat[:READings][:DATA]?	8-7
:INITiate:CONTInuous OFF ON 0 1	
:INITiate:CONTInuous?	8-8
:INITiate[:IMMEDIATE]	8-8
:MEASure:DEMod:CDPData?	8-9
:MEASure:OTA?	8-10
:MEASure:RF:EMISsion?	8-11

List of Commands by Mode

:MEASure:RF:SPECTrum?	8-12
:MMEMory:DELeTe <filename>	8-13
:MMEMory:LOAD:STATe <integer>,<filename>	8-13
:MMEMory:LOAD:TRACe <integer>,<filename>	8-13
:MMEMory:STORe:STATe <integer>,<filename>	8-14
:MMEMory:STORe:TRACe <integer>,<filename>	8-15
:READ:DEMod:CDPData?	8-16
:READ:OTA?	8-17
:READ:RF:EMISsion?	8-17
:READ:RF:PVTSlot?	8-18
:READ:RF:SPECTrum?	8-19
:TRACe:PREAmble? <trace type>	8-20
:TRACe[:DATA]? <trace type>	8-21
:UNIT:POWer DBM W	
:UNIT:POWer?	8-23
[[:SENSe]:DEMod:CDPData:UNITs RELative ABSolute	
[[:SENSe]:DEMod:CDPData:UNITs?	8-24
[[:SENSe]:DEMod:MODType Auto QPSK 8PSK 16QAM	
[[:SENSe]:DEMod:MODType?	8-24
[[:SENSe]:DEMod:MUSer Auto 2-16 (even)	
[[:SENSe]:DEMod:MUSer?	8-24
[[:SENSe]:DEMod:SCRamblingcode Auto 0-127	
[[:SENSe]:DEMod:SCRamblingcode?	8-25
[[:SENSe]:DEMod:SPRFactor Auto 16 1	
[[:SENSe]:DEMod:SPRFactor?	8-25
[[:SENSe]:DWPTs Auto On Off	
[[:SENSe]:DWPTs?	8-25
[[:SENSe]:FREQuency:CENTer <freq>	
[[:SENSe]:FREQuency:CENTer?	8-26
[[:SENSe]:FREQuency:SIGStandard:CHANnel <number>	
[[:SENSe]:FREQuency:SIGStandard:CHANnel?	8-26
[[:SENSe]:FREQuency:SIGStandard:NAME <string>	
[[:SENSe]:FREQuency:SIGStandard:NAME?	8-26
[[:SENSe]:NUMCarriers 1 3	
[[:SENSe]:NUMCarriers?	8-27
[[:SENSe]:PFail <test set>	
[[:SENSe]:PFail?	8-27
[[:SENSe]:POWer[:RF]:RANGe:AUTO OFF ON 0 1	
[[:SENSe]:POWer[:RF]:RANGe:AUTO?	8-28
[[:SENSe]:POWer[:RF]:RANGe[:IMMEdiate]	8-28

[:SENSe]:SLOTselection Auto 0-6	
[:SENSe]:SLOTselection?	8-28
[:SENSe]:SWEep:SPEEd FAST NORM SLOW	
[:SENSe]:SWEep:SPEEd?	8-29
[:SENSe]:SYDLcode Auto 0-31	
[:SENSe]:SYDLcode?	8-29
[:SENSe]:TAU:OFFSet <integer>	
[:SENSe]:TAU:OFFSet?	8-29
[:SENSe]:TRIGger NOTRig GPS EXT	
[:SENSe]:TRIGger?	8-30
[:SENSe]:ULSWitchpoint 0-6	
[:SENSe]:ULSWitchpoint?	8-30

Chapter 9—CDMA Commands

:ABORt	9-1
:CALCulate:MARKer:AOFF	9-2
:CALCulate:MARKer{1 2 3 4 5 6}:Y?	9-2
:CALCulate:MARKer{1 2 3 4 5 6}[:STATe] OFF ON 0 1	
:CALCulate:MARKer{1 2 3 4 5 6}[:STATe]?	9-2
:CONFigure SUMMery PFail	9-3
:CONFigure:DEMod <char>	9-3
:CONFigure:OTA <char>.	9-4
:CONFigure:RF <char>.	9-4
:DISPlay:WINDow:TRACe:Y[:SCALe]:OFFSet <rel ampl>	
:DISPlay:WINDow:TRACe:Y[:SCALe]:OFFSet?	9-5
:DISPlay:WINDow:TRACe:Y[:SCALe]:PDIVision <rel ampl>	
:DISPlay:WINDow:TRACe:Y[:SCALe]:PDIVision?	9-5
:FETCh:DEMod:CDPower?	9-6
:FETCh:OTA:MPATH?	9-6
:FETCh:PFail?	9-7
:FETCh:RF:ACPR?	9-7
:FETCh:RF:EMISsion?	9-8
:FETCh:RF:SPECtrum?	9-8
:FORMat[:READings][:DATA] ASCii INTeger,32 REAL,32	
:FORMat[:READings][:DATA]?	9-9
:INITiate:CONTInuous OFF ON 0 1	
:INITiate:CONTInuous?	9-10
:INITiate[:IMMediate]	9-10
:MEASure:DEMod:CDPower?	9-11
:MEASure:OTA:MPATH?	9-12

List of Commands by Mode

:MEASure:PFail?	9-12
:MEASure:RF:ACPR?	9-13
:MEASure:RF:EMISsion?	9-13
:MEASure:RF:SPECTrum?	9-15
:MMEMory:DELete <filename>	9-16
:MMEMory:LOAD:STATe <integer>,<filename>	9-16
:MMEMory:LOAD:TRACe <integer>,<filename>	9-16
:MMEMory:STORe:STATe <integer>,<filename>	9-17
:MMEMory:STORe:TRACe <integer>,<filename>	9-18
:READ:DEMod:CDPower?	9-19
:READ:OTA:MPATH?	9-19
:READ:PFail?	9-20
:READ:RF:ACPR?	9-20
:READ:RF:EMISsion?	9-21
:READ:RF:SPECTrum?	9-22
:TRACe:PREamble? <trace type>	9-23
:TRACe[:DATA]? <trace type>	9-24
:TRIGger:SEQuence:SLOPe RISING FALLing	
:TRIGger:SEQuence:SLOPe?	9-26
:UNIT:POWER DBM W	
:UNIT:POWER?	9-27
[:SENSe]:ACPower:BANDwidth:MAIN <freq>	
[:SENSe]:ACPower:BANDwidth:MAIN?	9-28
[:SENSe]:DEMod:CDPower:UNITs RELative ABSolute	
[:SENSe]:DEMod:CDPower:UNITs?	9-28
[:SENSe]:DEMod:CDPower:ZOOM 16 32 64	
[:SENSe]:DEMod:CDPower:ZOOM?	9-29
[:SENSe]:DEMod:CDPower:ZOOM:START <integer>	
[:SENSe]:DEMod:CDPower:ZOOM:START?	9-29
[:SENSe]:FREQUency:CENTer <freq>	
[:SENSe]:FREQUency:CENTer?	9-29
[:SENSe]:FREQUency:SIGStandard:CHANnel <number>	
[:SENSe]:FREQUency:SIGStandard:CHANnel?	9-30
[:SENSe]:FREQUency:SIGStandard:NAME <string>	
[:SENSe]:FREQUency:SIGStandard:NAME?	9-30
[:SENSe]:FREQUency:SPAN?	9-30
[:SENSe]:PFail <test set>	
[:SENSe]:PFail?	9-31
[:SENSe]:PN:OFFSet <integer>	

[:SENSe]:PN:OFFSet?	9-31
[:SENSe]:PN:STYPe:AUTO 1 0 ON OFF [:SENSe]:PN:STYPe:AUTO?	9-32
[:SENSe]:PN:TRIGger NOTRig GPS EXT [:SENSe]:PN:TRIGger?	9-32
[:SENSe]:POWer[:RF]:RANGe:AUTO OFF ON 0 1 [:SENSe]:POWer[:RF]:RANGe:AUTO?	9-33
[:SENSe]:POWer[:RF]:RANGe[:IMMEDIATE]	9-33
[:SENSe]:RF:ACPR:MAINchannelcount <integer> [:SENSe]:RF:ACPR:MAINchannelcount?	9-33
[:SENSe]:SWEep:SPEEd FAST NORM SLOW [:SENSe]:SWEep:SPEEd?	9-34
[:SENSe]:WCODe 64 128 [:SENSe]:WCODe?	9-34

Chapter 10—EVDO Commands

:ABORT	10-1
:CALCulate:MARKer:AOFF	10-2
:CALCulate:MARKer{1 2 3 4 5 6}:Y?	10-2
:CALCulate:MARKer{1 2 3 4 5 6}[:STATe] OFF ON 0 1 [:CALCulate:MARKer{1 2 3 4 5 6}[:STATe]?	10-2
:CONFigure SUMMary PFail	10-3
:CONFigure:DEMod <char>	10-3
:CONFigure:OTA <char>	10-4
:CONFigure:RF <char>	10-4
:DISPlay:WINDow:TRACe:Y[:SCALe]:OFFSet <rel ampl> [:DISPlay:WINDow:TRACe:Y[:SCALe]:OFFSet?	10-5
:DISPlay:WINDow:TRACe:Y[:SCALe]:PDIVision <rel ampl> [:DISPlay:WINDow:TRACe:Y[:SCALe]:PDIVision?	10-5
:FETCh:DEMod:CDPData?	10-6
:FETCh:DEMod:CDPMac?	10-6
:FETCh:DEMod:SUMMary?	10-6
:FETCh:OTA:MPATH?	10-7
:FETCh:PFail?	10-7
:FETCh:RF:ACPR?	10-8
:FETCh:RF:EMISSion?	10-8
:FETCh:RF:SPECTrum?	10-9
:FORMat[:READings][:DATA] ASCii INTEger,32 REAL,32 [:FORMat[:READings][:DATA]?	10-10

List of Commands by Mode

:INITiate:CONTInuous OFF ON 0 1	
:INITiate:CONTInuous?	10-11
:INITiate[:IMMEDIATE].	10-11
:MEASure:DEMod:CDPData?	10-12
:MEASure:DEMod:CDPMac?	10-13
:MEASure:DEMod:SUMMary?	10-13
:MEASure:OTA:MPATH?	10-14
:MEASure:PFail?	10-14
:MEASure:RF:ACPR?	10-15
:MEASure:RF:EMISsion?	10-16
:MEASure:RF:SPECTrum?	10-16
:MMEMory:DELeTe <filename>	10-18
:MMEMory:LOAD:STATe <integer>,<filename>	10-18
:MMEMory:LOAD:TRACe <integer>,<filename>	10-18
:MMEMory:STORe:STATe <integer>,<filename>	10-19
:MMEMory:STORe:TRACe <integer>,<filename>	10-20
:READ:OTA:MPATH?	10-21
:READ:PFail?	10-21
:READ:RF:ACPR?	10-22
:READ:RF:EMISsion?	10-22
:READ:RF:SPECTrum?	10-23
:TRACe:PREAmble? <trace type>	10-24
:TRACe[:DATA]? <trace type>	10-25
:TRIGger:SEQuence:SLOPe RISing FALLing	
:TRIGger:SEQuence:SLOPe?	10-27
:UNIT:POWer DBM W	
:UNIT:POWer?	10-28
[[:SENSe]:ACPower:BANDwidth:MAIN <freq>	
[[:SENSe]:ACPower:BANDwidth:MAIN?	10-29
[[:SENSe]:DEMod:CDPower:UNITs RELative ABSolute	
[[:SENSe]:DEMod:CDPower:UNITs?	10-29
[[:SENSe]:DEMod:CDPower:ZOOM 16 32 64	
[[:SENSe]:DEMod:CDPower:ZOOM?	10-30
[[:SENSe]:DEMod:CDPower:ZOOM:START <integer>	
[[:SENSe]:DEMod:CDPower:ZOOM:START?	10-30
[[:SENSe]:FREQUency:CENTer <freq>	
[[:SENSe]:FREQUency:CENTer?	10-30
[[:SENSe]:FREQUency:SIGStandard:CHANnel <number>	

[:SENSe]:FREQuency:SIGStandard:CHANnel?	10-31
[:SENSe]:FREQuency:SIGStandard:NAME <string> [:SENSe]:FREQuency:SIGStandard:NAME?	10-31
[:SENSe]:FREQuency:SPAN?	10-31
[:SENSe]:PFail <test set> [:SENSe]:PFail?	10-32
[:SENSe]:PN:OFFSet <integer> [:SENSe]:PN:OFFSet?	10-32
[:SENSe]:PN:STYPe:AUTO 1 0 ON OFF [:SENSe]:PN:STYPe:AUTO?	10-33
[:SENSe]:PN:TRIGger NOTRig GPS EXT [:SENSe]:PN:TRIGger?	10-33
[:SENSe]:POWer[:RF]:RANGe:AUTO OFF ON 0 1 [:SENSe]:POWer[:RF]:RANGe:AUTO?	10-34
[:SENSe]:POWer[:RF]:RANGe[:IMMediate]	10-34
[:SENSe]:RF:ACPR:MAINchannelcount <integer> [:SENSe]:RF:ACPR:MAINchannelcount?	10-34
[:SENSe]:SWEep:SPEed FAST NORM SLOW [:SENSe]:SWEep:SPEed?	10-35
[:SENSe]:WCODe 64 128 [:SENSe]:WCODe?	10-35

Chapter 11—Fixed WiMAX Commands

:ABORT	11-1
:CONFigure SUMMary	11-2
:CONFigure:DEMod <char>	11-2
:CONFigure PFail	11-3
:CONFigure:RF <char>	11-3
:DISPlay:WINDow:TRACe:MAXHold OFF ON 0 1 :DISPlay:WINDow:TRACe:MAXHold?	11-5
:DISPlay:WINDow:TRACe:Y[:SCALe]:OFFSet <rel ampl> :DISPlay:WINDow:TRACe:Y[:SCALe]:OFFSet?	11-5
:DISPlay:WINDow:TRACe:Y[:SCALe]:PDIVision <value> :DISPlay:WINDow:TRACe:Y[:SCALe]:PDIVision?	11-6
:DISPlay:WINDow:TRACe:Y[:SCALe]:TOP <amplitude> :DISPlay:WINDow:TRACe:Y[:SCALe]:TOP?	11-6
:FETCh:DEMod:CONStIn?	11-7
:FETCh:DEMod:EVSCarrier?	11-7
:FETCh:DEMod:EVSYmbol?	11-7
:FETCh:DEMod:SFLatness?	11-7

List of Commands by Mode

:FETCh:PFail?	11-8
:FETCh:RF:ACPR?	11-8
:FETCh:RF:PVTime?	11-9
:FETCh:RF:SPECTrum?	11-9
:FORMat[:READings][:DATA] ASCii INTeger,32 REAL,32	
:FORMat[:READings][:DATA]?	11-10
:INITiate:CONTInuous OFF ON 0 1	
:INITiate:CONTInuous?	11-11
:INITiate[:IMMEDIATE].	11-11
:MEASure:DEMod:CONStIn?	11-12
:MEASure:DEMod:EVSCarrier?	11-12
:MEASure:DEMod:EVSYmbol?	11-13
:MEASure:DEMod:SFLatness?	11-13
:MEASure:PFail?	11-14
:MEASure:RF:ACPR?	11-14
:MEASure:RF:PVTime?	11-15
:MEASure:RF:SPECTrum?	11-15
:MMEMory:DELeTe <filename>	11-16
:MMEMory:LOAD:STATe <integer>,<filename>	11-16
:MMEMory:LOAD:TRACe <integer>,<filename>	11-16
:MMEMory:STORe:STATe <integer>,<filename>	11-17
:MMEMory:STORe:TRACe <integer>,<filename>	11-18
:READ:DEMod:CONStIn?	11-19
:READ:DEMod:EVSCarrier?	11-19
:READ:DEMod:EVSYmbol?	11-19
:READ:DEMod:SFLatness?	11-20
:READ:PFail?	11-20
:READ:RF:ACPR?	11-20
:READ:RF:PVTime?	11-21
:READ:RF:SPECTrum?	11-21
:TRACe:PREAmble? <trace type>	11-22
:TRACe[:DATA]? <trace type>	11-22
[:SENSe]:BANDwidth BWIDth[:RESolution] <index>	
[:SENSe]:BANDwidth BWIDth[:RESolution]?	11-24
[:SENSe]:CPRatio <index>	
[:SENSe]:CPRatio?	11-24
[:SENSe]:DEMod:CONStIn:POINts?	11-25

[:SENSe]:DEMod:CONStIn:REFPoints[:STATe] OFF ON 0 1	
[:SENSe]:DEMod:CONStIn:REFPoints[:STATe]?	11-25
[:SENSe]:DEMod:EVSCarrier:START:X?	11-25
[:SENSe]:DEMod:EVSCarrier:STOP:X?	11-25
[:SENSe]:DEMod:EVSYmbol:START:X?	11-25
[:SENSe]:DEMod:EVSYmbol:STOP:X?	11-25
[:SENSe]:DEMod:SFLatness:START:X?	11-26
[:SENSe]:DEMod:SFLatness:STOP:X?	11-26
[:SENSe]:DLFLength 2.5 5 10	
[:SENSe]:DLFLength?	11-26
[:SENSe]:FREQuency:CENTer <freq>	
[:SENSe]:FREQuency:CENTer?	11-26
[:SENSe]:FREQuency:SIGStandard:CHANnel <number>	
[:SENSe]:FREQuency:SIGStandard:CHANnel?	11-27
[:SENSe]:FREQuency:SIGStandard:NAME <string>	
[:SENSe]:FREQuency:SIGStandard:NAME?	11-27
[:SENSe]:PFail <test set>	
[:SENSe]:PFail?	11-27
[:SENSe]:POWer[:RF]:RANGe:AUTO OFF ON 0 1	
[:SENSe]:POWer[:RF]:RANGe:AUTO?	11-28
[:SENSe]:POWer[:RF]:RANGe[:IMMediate]	11-28
[:SENSe]:RF:ACPR:ADJCchannelcount?	11-28
[:SENSe]:RF:ACPR:MAINchannelcount?	11-29
[:SENSe]:RF:PVTime:FRAMe:START?	11-29
[:SENSe]:RF:PVTime:FRAMe:STOP?	11-29
[:SENSe]:RF:SPECTrum:SPAN 5 10 20 30	
[:SENSe]:RF:SPECTrum:SPAN?	11-29

Chapter 12—Mobile WiMAX Commands

:ABORT	12-1
:CONFigure PFail	12-2
:CONFigure SUMMary	12-2
:CONFigure:DEMod <char>	12-3
:CONFigure:RF <char>	12-3
:DISPlay:WINDow:TRACe:MAXHold OFF ON 0 1	
:DISPlay:WINDow:TRACe:MAXHold?	12-5
:DISPlay:WINDow:TRACe:Y[:SCALe]:OFFSet <rel ampl>	
:DISPlay:WINDow:TRACe:Y[:SCALe]:OFFSet?	12-5
:DISPlay:WINDow:TRACe:Y[:SCALe]:PDIVision <value>	
:DISPlay:WINDow:TRACe:Y[:SCALe]:PDIVision?	12-6

List of Commands by Mode

:DISPlay:WINDow:TRACe:Y[:SCALE]:TOP <amplitude>	
:DISPlay:WINDow:TRACe:Y[:SCALE]:TOP?	12-6
:FETCh:DEMod:CONStn?	12-7
:FETCh:DEMod:EVSCarrier?	12-7
:FETCh:DEMod:EVSYmbol?	12-7
:FETCh:DEMod:SFLatness?	12-7
:FETCh:PFail?	12-8
:FETCh:RF:ACPR?	12-8
:FETCh:RF:PVTime?	12-9
:FETCh:RF:SPECTrum?	12-9
:FORMat[:READings][:DATA] ASCii INTeger,32 REAL,32	
:FORMat[:READings][:DATA]?	12-10
:INITiate:CONTInuous OFF ON 0 1	
:INITiate:CONTInuous?	12-11
:INITiate[:IMMediate]	12-11
:MEASure:DEMod:CONStn?	12-12
:MEASure:DEMod:EVSCarrier?	12-12
:MEASure:DEMod:EVSYmbol?	12-13
:MEASure:DEMod:SFLatness?	12-13
:MEASure:PFail?	12-14
:MEASure:RF:ACPR?	12-14
:MEASure:RF:PVTime?	12-15
:MEASure:RF:SPECTrum?	12-15
:MMEMory:DELeTe <filename>	12-16
:MMEMory:LOAD:STATe <integer>,<filename>	12-16
:MMEMory:LOAD:TRACe <integer>,<filename>	12-16
:MMEMory:STORE:STATe <integer>,<filename>	12-17
:MMEMory:STORE:TRACe <integer>,<filename>	12-18
:READ:DEMod:CONStn?	12-19
:READ:DEMod:EVSCarrier?	12-19
:READ:DEMod:EVSYmbol?	12-19
:READ:DEMod:SFLatness?	12-20
:READ:PFail?	12-20
:READ:RF:ACPR?	12-20
:READ:RF:PVTime?	12-21
:READ:RF:SPECTrum?	12-21
:TRACe:PREamble? <trace type>	12-22
:TRACe[:DATA]? <trace type>	12-22
[:SENSe]:BANDwidth BWIDth[:RESolution] <index>	

[:SENSe]:BANDwidth BWIDth[:RESolution]?	12-24
[:SENSe]:DEMod:CONStIn:REFPoints[:STATe] OFF ON 0 1	
[:SENSe]:DEMod:CONStIn:REFPoints[:STATe]?	12-24
[:SENSe]:FREQuency:CENTer <freq>	
[:SENSe]:FREQuency:CENTer?	12-25
[:SENSe]:FREQuency:SIGStandard:CHANnel <number>	
[:SENSe]:FREQuency:SIGStandard:CHANnel?	12-25
[:SENSe]:FREQuency:SIGStandard:NAME <string>	
[:SENSe]:FREQuency:SIGStandard:NAME?	12-25
[:SENSe]:PFail <test set>	
[:SENSe]:PFail?	12-26
[:SENSe]:POWer[:RF]:RANGe:AUTO OFF ON 0 1	
[:SENSe]:POWer[:RF]:RANGe:AUTO?	12-26
[:SENSe]:POWer[:RF]:RANGe[:IMMediate]	12-27
[:SENSe]:RF:SPECtrum:SPAN 5 10 20 30	
[:SENSe]:RF:SPECtrum:SPAN?	12-27

Chapter 13—LTE Commands

:ABORt	13-1
:CALCulate:MARKer:AOFF	13-2
:CALCulate:MARKer1:DELTA:X <x1 parameter>	
:CALCulate:MARKer1:DELTA:X?	13-2
:CALCulate:MARKer1:DELTA:Y?	13-2
:CALCulate:MARKer1:MAXimum	13-2
:CALCulate:MARKer1:STATe OFF ON DELTA	
:CALCulate:MARKer1:STATe?	13-3
:CALCulate:MARKer1:X <x-parameter>	
:CALCulate:MARKer1:X?	13-3
:CALCulate:MARKer1:Y?	13-3
:CALCulate:MARKer2:DELTA:X <x1 parameter>	
:CALCulate:MARKer2:DELTA:X?	13-3
:CALCulate:MARKer2:DELTA:Y?	13-4
:CALCulate:MARKer2:MAXimum	13-4
:CALCulate:MARKer2:STATe OFF ON DELTA	
:CALCulate:MARKer2:STATe?	13-4
:CALCulate:MARKer2:X <x-parameter>	
:CALCulate:MARKer2:X?	13-4
:CALCulate:MARKer2:Y?	13-5
:CONFigure?	13-6
:CONFigure:DEMod SUMMery CONStIn CCPGraph CCPTTable TIMEalign	13-7
:CONFigure:OTA SCANner TXTEst MAPping CAGGregation	13-7

List of Commands by Mode

:CONFigure:RF SUMMary SPECTrum ACLR SEM	13-8
:CONFigure:OTA CAGGregation	13-8
:CONFigure:OTA SCANner TXTEst MAPping CAGGregation	13-8
:CONFigure SUMMary	13-9
:DISPlay:WINDow:TRACe:Y[:SCALe]:OFFSet <rel ampl>	
:DISPlay:WINDow:TRACe:Y[:SCALe]:OFFSet?	13-10
:DISPlay:WINDow:TRACe:Y[:SCALe]:PDIVision <rel ampl>	
:DISPlay:WINDow:TRACe:Y[:SCALe]:PDIVision?	13-10
:FETCh:DEMod:4x4:TIMEalign?	13-11
:FETCh:DEMod:CCPData?	13-11
:FETCh:DEMod:CONStIn?	13-12
:FETCh:DEMod:PVRB?	13-12
:FETCh:DEMod:TIMEalign?	13-12
:FETCh:OTA:C4AGGregation?	13-13
:FETCh:OTA:CAGGregation?	13-13
:FETCh:OTA:MAPping?	13-13
:FETCh:OTA:SCANner?	13-14
:FETCh:OTA:TXTEst?	13-14
:FETCh:RF:ACLR?	13-14
:FETCh:RF:SEM?	13-14
:FETCh:RF:SPECTrum?	13-15
:FETCh:SUMMary?	13-15
:FORMat[:READings][:DATA] ASCii INTEger,32 REAL,32	
:FORMat[:READings][:DATA]?	13-16
:INITiate:CONTInuous OFF ON 0 1	
:INITiate:CONTInuous?	13-17
:INITiate[:IMMediate].	13-17
:MEASure:DEMod:4x4:TIMEalign?	13-18
:MEASure:DEMod:CCPData?	13-18
:MEASure:DEMod:CONStIn?	13-19
:MEASure:DEMod:TIMEalign?	13-19
:MEASure:OTA:C4AGGregation?	13-19
:MEASure:OTA:CAGGregation?	13-20
:MEASure:OTA:MAPping?	13-20
:MEASure:OTA:MAPping:RUN START STOP	
:MEASure:OTA:MAPping:RUN?	13-20
:MEASure:OTA:SCANner?	13-21

:MEASure:OTA:TXTEst?	13-21
:MEASure:RF:ACLR?	13-21
:MEASure:RF:SEM?	13-22
:MEASure:RF:SPECtrum?	13-22
:READ:DEMod:4x4:TIMEalign?	13-23
:READ:DEMod:CONSTln?	13-23
:READ:DEMod:TIMEalign?	13-24
:READ:OTA:C4AGGregation?	13-24
:READ:OTA:CAGGregation?	13-25
:READ:OTA:MAPping?	13-25
:READ:OTA:SCANner?	13-25
:READ:OTA:TXTEst?	13-26
:READ:PFail?	13-26
:READ:RF:ACLR?	13-27
:READ:RF:SEM?	13-27
:READ:RF:SPECtrum?	13-27
:UNIT:POWer DBM W	
:UNIT:POWer?	13-28
[:SENSe]:4TAE:ACTive OFF ON	
[:SENSe]:4TAE:ACTive?	13-29
[:SENSe]:BANDWidth[:RESolution] 1.4 3 5 10 15 20	
[:SENSe]:BANDWidth[:RESolution]?	13-29
[:SENSe]:CC{1 2 3 4 5}:ACTive OFF ON	
[:SENSe]:CC{1 2 3 4 5}:ACTive?	13-29
[:SENSe]:CC{1 2 3 4 5}:BANDWidth 1.4 3 5 10 15 20	
[:SENSe]:CC{1 2 3 4 5}:BANDWidth?	13-30
[:SENSe]:CC{1 2 3 4 5}:CHANnel <number>	
[:SENSe]:CC{1 2 3 4 5}:CHANnel?	13-30
[:SENSe]:CC{1 2 3 4 5}:FREQuency <freq>	
[:SENSe]:CC{1 2 3 4 5}:FREQuency?	13-30
[:SENSe]:CC{1 2 3 4 5}:SIGStandard <string>	
[:SENSe]:CC{1 2 3 4 5}:SIGStandard?	13-30
[:SENSe]:CELLID <char>	
[:SENSe]:CELLID?	13-31
[:SENSe]:EMF:STATe OFF ON 0 1	
[:SENSe]:EMF:STATe?	13-31
[:SENSe]:EVM:MODE AUTO PBCHonly	
[:SENSe]:EVM:MODE?	13-32
[:SENSe]:FREQuency:CENTer <freq>	

List of Commands by Mode

[[:SENSE]:FREQUENCY:CENTer?	13-32
[[:SENSE]:FREQUENCY:SIGStandard:CHANnel <number> [[:SENSE]:FREQUENCY:SIGStandard:CHANnel?	13-32
[[:SENSE]:FREQUENCY:SIGStandard:NAME [String] [[:SENSE]:FREQUENCY:SIGStandard:NAME?	13-32
[[:SENSE]:LTE:STATus?	13-33
[[:SENSE]:POWER[:RF]:RANGE[:IMMEdiate]	13-33
[[:SENSE]:POWER[:RF]:RANGE:AUTO <Boolean (default=1 [ON])> [[:SENSE]:POWER[:RF]:RANGE:AUTO?	13-33
[[:SENSE]:RF:SPECTrum:SPAN Auto 1.4 3 5 10 15 20 30 [[:SENSE]:RF:SPECTrum:SPAN?	13-34
[[:SENSE]:SYNC:TYPE SS RS [[:SENSE]:SYNC:TYPE?	13-34
[[:SENSE]:TAE:ACTive OFF ON [[:SENSE]:TAE:ACTive?	13-34

Chapter 14—AM/FM/PM Commands

:CALCulate:MARKer{1 2 3 4 5 6}[:STATe] OFF ON 0 1 :CALCulate:MARKer{1 2 3 4 5 6}[:STATe]?	14-1
:CALCulate:MARKer{1 2 3 4 5 6}:DELTA[:STATe] OFF ON 0 1 :CALCulate:MARKer{1 2 3 4 5 6}:DELTA[:STATe]?	14-1
:CALCulate:MARKer{1 2 3 4 5 6}:DELTA:X <x-parameter> :CALCulate:MARKer{1 2 3 4 5 6}:DELTA:X?	14-2
:CALCulate:MARKer{1 2 3 4 5 6}:DELTA:Y?	14-2
:CALCulate:MARKer{1 2 3 4 5 6}[:SET]:CENTer	14-2
:CALCulate:MARKer{1 2 3 4 5 6}:MAXimum	14-3
:CALCulate:MARKer{1 2 3 4 5 6}[:SET]:RLEVel	14-3
:CALCulate:MARKer{1 2 3 4 5 6}:X <x-parameter> :CALCulate:MARKer{1 2 3 4 5 6}:X?	14-3
:CALCulate:MARKer{1 2 3 4 5 6}:Y?	14-3
:CALCulate:MARKer:AOFF	14-4
:CALCulate:MARKer:TABLE[:STATe] OFF ON :CALCulate:MARKer:TABLE[:STATe]?	14-4
:DISPlay:WINDow:TRACe:Y:ADJust	14-5
:DISPlay:WINDow:TRACe:Y[:SCALe]:PDIVision <rel ampl> :DISPlay:WINDow:TRACe:Y[:SCALe]:PDIVision?	14-5
:DISPlay:WINDow:TRACe:Y:AFPAnalyzer:PWR:OFFSet <rel ampl> :DISPlay:WINDow:TRACe:Y:AFPAnalyzer:PWR:OFFSet?	14-5
:FORMat[:READings][:DATA] ASCii INTEger,32 REAL,[<length>] :FORMat[:READings][:DATA]?	14-6
:INITiate[:IMMEdiate].	14-8

:INITiate:CONTInuous OFF ON 0 1	
:INITiate:CONTInuous?	14-8
:MMEMory:DELeTe <filename>	14-9
:MMEMory:LOAD:STATe <integer>,<filename>	14-9
:MMEMory:LOAD:TRACe <integer>,<filename>	14-9
:MMEMory:STORe:STATe <integer>,<filename>	14-10
:MMEMory:STORe:TRACe <integer>,<filename>	14-11
:TRACe[:DATA]?	14-12
[:SENSe]:AFPanalyzer:AVERage:COUNT <avg count>	
[:SENSe]:AFPanalyzer:AVERage:COUNT?	14-13
[:SENSe]:AFPanalyzer:DEMod:DATA?	14-13
[:SENSe]:AFPanalyzer:DEMod:MODE RFSP AFSP AFWV SUMMary	
[:SENSe]:AFPanalyzer:DEMod:MODE?	14-13
[:SENSe]:AFPanalyzer:DEMod:TYPE AM FM PM	
[:SENSe]:AFPanalyzer:DEMod:TYPE?	14-14
[:SENSe]:AFPanalyzer:FM:SCALE <percentage>	
[:SENSe]:AFPanalyzer:FM:SCALE?	14-14
[:SENSe]:AFPanalyzer:IFBW <freq>	
[:SENSe]:AFPanalyzer:IFBW?	14-14
[:SENSe]:AFPanalyzer:IFBW:AUTO 0 1	
[:SENSe]:AFPanalyzer:IFBW:AUTO?	14-15
[:SENSe]:AFPanalyzer:PM:SCALE <Radians>	
[:SENSe]:AFPanalyzer:PM:SCALE?	14-15
[:SENSe]:AFPanalyzer:RFSPectrum:DATA?	14-15
[:SENSe]:AFPanalyzer:SPAN <freq>	
[:SENSe]:AFPanalyzer:SPAN?	14-16
[:SENSe]:AFPanalyzer:SWEep:TIME <time>	
[:SENSe]:AFPanalyzer:SWEep:TIME?	14-16
[:SENSe]:AFPanalyzer:SUMMary:DATA?	14-16
[:SENSe]:FREQuency:CENTer <freq>	
[:SENSe]:FREQuency:CENTer?	14-17
[:SENSe]:FREQuency:SIGStandard:CHANnel <number>	
[:SENSe]:FREQuency:SIGStandard:CHANnel?	14-17
[:SENSe]:FREQuency:SIGStandard:NAME <string>	
[:SENSe]:FREQuency:SIGStandard:NAME?	14-17
[:SENSe]:FREQuency:SPAN <freq>	
[:SENSe]:FREQuency:SPAN?	14-18
[:SENSe]:FREQuency:SPAN:FULL	14-18
[:SENSe]:FREQuency:SPAN:MINimum	14-18
[:SENSe]:FREQuency:SPAN:PREVIOUS	14-18
[:SENSe]:FREQuency:STEP[:INCRement] <freq>	
[:SENSe]:FREQuency:STEP[:INCRement]?	14-18

List of Commands by Mode

[[:SENSE]:OBWidth:METHOD XDB PERCent [:SENSE]:OBWidth:METHOD?	14-19
[[:SENSE]:OBWidth:PERCent <percentage> [:SENSE]:OBWidth:PERCent?	14-19
[[:SENSE]:OBWidth:XDB <rel ampl> [:SENSE]:OBWidth:XDB?	14-20

Chapter 15—Tracking Generator Commands

:CONFigure:GENerator:TRACking POWStats TXStats :CONFigure?	15-1
:FETCh:TGENerator:POWStats?.....	15-3
:FETCh:TGENerator:TXStats?.....	15-3
:GENerator:ADditiONal:CALibratiON	15-4
:GENerator:OUTput:POWer <amplitude> :GENerator:OUTput:POWer?.....	15-4
:GENerator:OUTput:POWer:OFFSet[:MAGNitude] <value> :GENerator:OUTput:POWer:OFFSet[:MAGNitude]?	15-5
:INITiate:GENerator OFF ON 0 1 :INITiate:GENerator?	15-6
:MEASure:TGENerator:POWStats?.....	15-7
:READ:TGENerator:POWStats?	15-8
:READ:TGENerator:TXStats?	15-8
[[:SENSE]:CW:FREQuency [:SENSE]:CW:FREQuency?	15-9
[[:SENSE]:GENerator:MODE CW TRACking [:SENSE]:GENerator:MODE?	15-9
[[:SENSE]:GENerator:ENhanced:CALibratiON[:STATe] OFF ON 0 1 [:SENSE]:GENerator:ENhanced:CALibratiON[:STATe]?	15-10
[[:SENSE]:ENhanced:CALibratiON:COMPLete[:STATe]?	15-10
[[:SENSE]:MATChing:PADS 0 1 2 [:SENSE]:MATChing:PADS?.....	15-11
[[:SENSE]:TGENerator:POWStats[:STATe] OFF ON 0 1 [:SENSE]:TGENerator:POWStats[:STATe]?	15-11
[[:SENSE]:TGENerator:TX:NORMalize[:STATe] OFF ON 0 1 [:SENSE]:TGENerator:TX:NORMalize[:STATe]?	15-12
[[:SENSE]:TGENerator:TX[:SCALe]:PDIVision <rel ampl> [:SENSE]:TGENerator:TX[:SCALe]:PDIVision?	15-12
[[:SENSE]:TGENerator:TX[:SCALe]:RLEVel <amplitude> [:SENSE]:TGENerator:TX[:SCALe]:RLEVel?.....	15-13
[[:SENSE]:TGENerator:TX[:SCALe]:RLEVel:OFFSet <rel ampl> [:SENSE]:TGENerator:TX[:SCALe]:RLEVel:OFFSet?	15-13
[[:SENSE]:TGENerator:TXStats[:STATe] OFF ON 0 1 [:SENSE]:TGENerator:TXStats[:STATe]?	15-13

Appendix C — List of Commands, Alphabetical

All SCPI Commands in Alphabetic List

:ABORt	10-1
:ABORt	11-1
:ABORt	12-1
:ABORt	13-1
:ABORt	5-1
:ABORt	6-1
:ABORt	7-1
:ABORt	8-1
:ABORt	9-1
:CALCulate:LIMit:ALARm OFF ON 0 1	
:CALCulate:LIMit:ALARm?	4-1
:CALCulate:LIMit:ALARm OFF ON 0 1	
:CALCulate:LIMit:ALARm?	5-2
:CALCulate:LIMit:CENTer	5-2
:CALCulate:LIMit:CLEar	4-1
:CALCulate:LIMit:ENVelope:CREate	5-3
:CALCulate:LIMit:ENVelope:OFFSet <amplitude>	
:CALCulate:LIMit:ENVelope:OFFSet?	5-3
:CALCulate:LIMit:ENVelope:POINt <number>	
:CALCulate:LIMit:ENVelope:POINt?	5-4
:CALCulate:LIMit:ENVelope:SHAPe SQUare SLOPe	
:CALCulate:LIMit:ENVelope:SHAPe?	5-4
:CALCulate:LIMit:ENVelope:UPDate:Y	5-4
:CALCulate:LIMit:FAIL?	5-5
:CALCulate:LIMit:LOWer:ALARm OFF ON 0 1	
:CALCulate:LIMit:LOWer:ALARm?	5-5
:CALCulate:LIMit:LOWer:FAIL?	5-5
:CALCulate:LIMit:LOWer:POINt?	5-5
:CALCulate:LIMit:LOWer[:STATe] OFF ON 0 1	
:CALCulate:LIMit:LOWer[:STATe]?	5-6
:CALCulate:LIMit:LTYPe ABSolute RELative	
:CALCulate:LIMit:LTYPe?	5-6
:CALCulate:LIMit:MIRRor	5-7
:CALCulate:LIMit:POINt:ADD	4-1
:CALCulate:LIMit:POINt:ADD	5-7
:CALCulate:LIMit:POINt:DELeTe	5-7
:CALCulate:LIMit:POINt:FREQuency <freq>	

:CALCulate:LIMit:POINT:FREQuency?	4-2
:CALCulate:LIMit:POINT:LEFT	5-7
:CALCulate:LIMit:POINT:RIGHT	5-8
:CALCulate:LIMit:POINT:VALue <value>	
:CALCulate:LIMit:POINT:VALue?	4-2
:CALCulate:LIMit:POINT:X <x-parameter>	
:CALCulate:LIMit:POINT:X?	5-8
:CALCulate:LIMit:POINT:Y <y-parameter>	
:CALCulate:LIMit:POINT:Y?	5-9
:CALCulate:LIMit:POINT?	4-2
:CALCulate:LIMit:POINT?	5-9
:CALCulate:LIMit:TYPe 0 1	
:CALCulate:LIMit:TYPe?	5-9
:CALCulate:LIMit:UPPer:ALARm OFF ON 0 1	
:CALCulate:LIMit:UPPer:ALARm?	5-10
:CALCulate:LIMit:UPPer:FAIL?	5-10
:CALCulate:LIMit:UPPer:POINT?	5-10
:CALCulate:LIMit:UPPer[:STATe] OFF ON 0 1	
:CALCulate:LIMit:UPPer[:STATe]?	5-11
:CALCulate:LIMit:VALue <value>	5-11
:CALCulate:LIMit:VERTical:ADD	5-12
:CALCulate:LIMit:X <x-parameter>	5-12
:CALCulate:LIMit:Y <y-parameter>	5-12
:CALCulate:LIMit[:SET]:DEFault	5-13
:CALCulate:LIMit[:STATe] OFF ON 0 1	
:CALCulate:LIMit[:STATe]?	4-3
:CALCulate:LIMit[:STATe] OFF ON 0 1	
:CALCulate:LIMit[:STATe]?	5-13
:CALCulate:MARKer:AOFF	10-2
:CALCulate:MARKer:AOFF	13-2
:CALCulate:MARKer:AOFF	4-3
:CALCulate:MARKer:AOFF	5-14
:CALCulate:MARKer:AOFF	7-2
:CALCulate:MARKer:AOFF	9-2
:CALCulate:MARKer:AOFF	14-4
:CALCulate:MARKer:PEAK:THReshold <percentage>	
:CALCulate:MARKer:PEAK:THReshold?	5-14
:CALCulate:MARKer:TABLE:DATA?	4-4
:CALCulate:MARKer:TABLE[:STATe] OFF ON	
:CALCulate:MARKer:TABLE[:STATe]?	4-4
:CALCulate:MARKer:TABLE[:STATe] OFF ON	
:CALCulate:MARKer:TABLE[:STATe]?	5-14
:CALCulate:MARKer:TABLE[:STATe] OFF ON	

List of Commands, Alphabetical

:CALCulate:MARKer:TABLE[:STATe]?	14-4
:CALCulate:MARKer{1 2 3 4 5 6}:DELTA:NOISE[:STATe] OFF ON 0 1	
:CALCulate:MARKer{1 2 3 4 5 6}:DELTA:NOISE[:STATe]?	5-15
:CALCulate:MARKer{1 2 3 4 5 6}:DELTA:X <x-parameter>	
:CALCulate:MARKer{1 2 3 4 5 6}:DELTA:X?	14-2
:CALCulate:MARKer{1 2 3 4 5 6}:DELTA:X <x-parameter>	
:CALCulate:MARKer{1 2 3 4 5 6}:DELTA:X?	4-5
:CALCulate:MARKer{1 2 3 4 5 6}:DELTA:X <x-parameter>	
:CALCulate:MARKer{1 2 3 4 5 6}:DELTA:X?	5-15
:CALCulate:MARKer{1 2 3 4 5 6}:DELTA:Y?	4-5
:CALCulate:MARKer{1 2 3 4 5 6}:DELTA:Y?	5-16
:CALCulate:MARKer{1 2 3 4 5 6}:DELTA:Y?	14-2
:CALCulate:MARKer{1 2 3 4 5 6}:DELTA[:SET]:SPAN.	5-16
:CALCulate:MARKer{1 2 3 4 5 6}:DELTA[:STATe] OFF ON 0 1	
:CALCulate:MARKer{1 2 3 4 5 6}:DELTA[:STATe]?	14-1
:CALCulate:MARKer{1 2 3 4 5 6}:DELTA[:STATe] OFF ON 0 1	
:CALCulate:MARKer{1 2 3 4 5 6}:DELTA[:STATe]?	4-5
:CALCulate:MARKer{1 2 3 4 5 6}:DELTA[:STATe] OFF ON 0 1	
:CALCulate:MARKer{1 2 3 4 5 6}:DELTA[:STATe]?	5-16
:CALCulate:MARKer{1 2 3 4 5 6}:FCOUNT[:STATe] OFF ON 0 1	
:CALCulate:MARKer{1 2 3 4 5 6}:FCOUNT[:STATe]?	5-17
:CALCulate:MARKer{1 2 3 4 5 6}:FIXed[:STATe] OFF ON 0 1	
:CALCulate:MARKer{1 2 3 4 5 6}:FIXed[:STATe]?	5-17
:CALCulate:MARKer{1 2 3 4 5 6}:MAXimum	5-18
:CALCulate:MARKer{1 2 3 4 5 6}:MAXimum	14-3
:CALCulate:MARKer{1 2 3 4 5 6}:MAXimum:LEFT	5-18
:CALCulate:MARKer{1 2 3 4 5 6}:MAXimum:NEXT	5-18
:CALCulate:MARKer{1 2 3 4 5 6}:MAXimum:RIGHT	5-18
:CALCulate:MARKer{1 2 3 4 5 6}:NOISE[:STATe] OFF ON 0 1	
:CALCulate:MARKer{1 2 3 4 5 6}:NOISE[:STATe]?	5-19
:CALCulate:MARKer{1 2 3 4 5 6}:PEAK	4-6
:CALCulate:MARKer{1 2 3 4 5 6}:VALley	4-6
:CALCulate:MARKer{1 2 3 4 5 6}:X <x-parameter>	
:CALCulate:MARKer{1 2 3 4 5 6}:X?	14-3
:CALCulate:MARKer{1 2 3 4 5 6}:X <x-parameter>	
:CALCulate:MARKer{1 2 3 4 5 6}:X?	4-6
:CALCulate:MARKer{1 2 3 4 5 6}:X <x-parameter>	
:CALCulate:MARKer{1 2 3 4 5 6}:X?	5-20
:CALCulate:MARKer{1 2 3 4 5 6}:X <x-parameter>	
:CALCulate:MARKer{1 2 3 4 5 6}:X?	7-2
:CALCulate:MARKer{1 2 3 4 5 6}:Y?	10-2
:CALCulate:MARKer{1 2 3 4 5 6}:Y?	4-6
:CALCulate:MARKer{1 2 3 4 5 6}:Y?	5-20

:CALCulate:MARKer{1 2 3 4 5 6}:Y?	7-2
:CALCulate:MARKer{1 2 3 4 5 6}:Y?	9-2
:CALCulate:MARKer{1 2 3 4 5 6}:Y?	14-3
:CALCulate:MARKer{1 2 3 4 5 6}[:SET]:CENTer	5-21
:CALCulate:MARKer{1 2 3 4 5 6}[:SET]:CENTer	14-2
:CALCulate:MARKer{1 2 3 4 5 6}[:SET]:RLEVel	5-21
:CALCulate:MARKer{1 2 3 4 5 6}[:SET]:RLEVel	14-3
:CALCulate:MARKer{1 2 3 4 5 6}[:STATe] OFF ON 0 1	
:CALCulate:MARKer{1 2 3 4 5 6}[:STATe]?	14-1
:CALCulate:MARKer{1 2 3 4 5 6}[:STATe] OFF ON 0 1	
:CALCulate:MARKer{1 2 3 4 5 6}[:STATe]?	10-2
:CALCulate:MARKer{1 2 3 4 5 6}[:STATe] OFF ON 0 1	
:CALCulate:MARKer{1 2 3 4 5 6}[:STATe]?	4-7
:CALCulate:MARKer{1 2 3 4 5 6}[:STATe] OFF ON 0 1	
:CALCulate:MARKer{1 2 3 4 5 6}[:STATe]?	5-21
:CALCulate:MARKer{1 2 3 4 5 6}[:STATe] OFF ON 0 1	
:CALCulate:MARKer{1 2 3 4 5 6}[:STATe]?	7-3
:CALCulate:MARKer{1 2 3 4 5 6}[:STATe] OFF ON 0 1	
:CALCulate:MARKer{1 2 3 4 5 6}[:STATe]?	9-2
:CALCulate:MARKer1:DELTA:X <x1 parameter>	
:CALCulate:MARKer1:DELTA:X?	13-2
:CALCulate:MARKer1:DELTA:Y?	13-2
:CALCulate:MARKer1:MAXimum	13-2
:CALCulate:MARKer1:STATe OFF ON DELTA	
:CALCulate:MARKer1:STATe?.	13-3
:CALCulate:MARKer1:X <x-parameter>	
:CALCulate:MARKer1:X?	13-3
:CALCulate:MARKer1:Y?	13-3
:CALCulate:MARKer2:DELTA:X <x1 parameter>	
:CALCulate:MARKer2:DELTA:X?	13-3
:CALCulate:MARKer2:DELTA:Y?	13-4
:CALCulate:MARKer2:MAXimum	13-4
:CALCulate:MARKer2:STATe OFF ON DELTA	
:CALCulate:MARKer2:STATe?.	13-4
:CALCulate:MARKer2:X <x-parameter>	
:CALCulate:MARKer2:X?	13-4
:CALCulate:MARKer2:Y?	13-5
:CALCulate:MATH:FUNCTION NORMAL ADD SUBTRACT	
:CALCulate:MATH:FUNCTION?.	4-7
:CALCulate:MATH:MEMorize	4-7
:CALCulate:MATH:OVERlay ON OFF.	4-8
:CALCulate:SMOothing <integer>	
:CALCulate:SMOothing?	4-8

List of Commands, Alphabetical

:CALCulate:TRANSform:CLAVerage?	4-8
:CALCulate:TRANSform:DISTance:CABLoss	
:CALCulate:TRANSform:DISTance:CABLoss?	4-8
:CALCulate:TRANSform:DISTance:DMAX?	4-9
:CALCulate:TRANSform:DISTance:FRESolution?	4-9
:CALCulate:TRANSform:DISTance:PVELocity	
:CALCulate:TRANSform:DISTance:PVELocity?	4-9
:CALCulate:TRANSform:DISTance:START	
:CALCulate:TRANSform:DISTance:START?	4-9
:CALCulate:TRANSform:DISTance:STOP	
:CALCulate:TRANSform:DISTance:STOP?	4-10
:CALCulate:TRANSform:DISTance:UNIT METers FEET	
:CALCulate:TRANSform:DISTance:UNIT?	4-10
:CALCulate:TRANSform:DISTance:WINDow RECTangular MSLobe NSLobe LSLobe	
:CALCulate:TRANSform:DISTance:WINDow?	4-10
:CALibration:STATe?	4-11
:CONFigure PFail	11-3
:CONFigure PFail	12-2
:CONFigure SUMMary	11-2
:CONFigure SUMMary	12-2
:CONFigure SUMMary	13-9
:CONFigure SUMMary PFail	10-3
:CONFigure SUMMary PFail	7-4
:CONFigure SUMMary PFail	8-2
:CONFigure SUMMary PFail	9-3
:CONFigure:ACPower.	5-22
:CONFigure:CHPower.	5-22
:CONFigure:DEMod <char>	10-3
:CONFigure:DEMod <char>	11-2
:CONFigure:DEMod <char>	12-3
:CONFigure:DEMod <char>	7-4
:CONFigure:DEMod <char>	8-2
:CONFigure:DEMod <char>	9-3
:CONFigure:DEMod SUMMary CONStln CCPGraph CCPTable TIMEalign	13-7
:CONFigure:DEMod	6-2
:CONFigure:FSTRength	5-23
:CONFigure:GENERator:TRACKing POWStats TXStats	
:CONFigure?	15-1
:CONFigure:MEASure:1PHase.	3-1
:CONFigure:MEASure:1PHase.	4-12
:CONFigure:MEASure:ACTiveChan 0 1	
:CONFigure:MEASure:ACTiveChan?	3-1

:CONFigure:MEASure:ACTiveChan 0 1	
:CONFigure:MEASure:ACTiveChan?	4-12
:CONFigure:MEASure:CABLoss.	3-2
:CONFigure:MEASure:CABLoss.	4-13
:CONFigure:MEASure:DUALdisplay DUAL SINGLE	
:CONFigure:MEASure:DUALdisplay?	3-2
:CONFigure:MEASure:DUALdisplay DUAL SINGLE	
:CONFigure:MEASure:DUALdisplay?	4-13
:CONFigure:MEASure:RLDTf.	3-2
:CONFigure:MEASure:RLDTf.	4-13
:CONFigure:MEASure:RLFReq.	3-2
:CONFigure:MEASure:RLFReq.	4-13
:CONFigure:MEASure:SMCHart.	3-2
:CONFigure:MEASure:SMCHart.	4-13
:CONFigure:MEASure:SWRDtf.	3-3
:CONFigure:MEASure:SWRDtf.	4-14
:CONFigure:MEASure:SWRFreq.	3-3
:CONFigure:MEASure:SWRFreq.	4-14
:CONFigure:MEASure?	3-1
:CONFigure:MEASure?	4-12
:CONFigure:OBWidth	5-23
:CONFigure:OTA <char>	10-4
:CONFigure:OTA <char>	9-4
:CONFigure:OTA CAGGregation	13-8
:CONFigure:OTA SCANner TXTEst MAPping CAGGregation	13-7
:CONFigure:OTA SCANner TXTEst MAPping CAGGregation	13-8
:CONFigure:OTA	7-5
:CONFigure:OTA	8-3
:CONFigure:PFail	6-3
:CONFigure:PVTFrame	6-3
:CONFigure:PVTSlot	6-4
:CONFigure:RF <char>.	10-4
:CONFigure:RF <char>.	11-3
:CONFigure:RF <char>.	12-3
:CONFigure:RF <char>.	7-5
:CONFigure:RF <char>.	8-3
:CONFigure:RF <char>.	9-4
:CONFigure:RF SUMMary SPECtrum ACLR SEM	13-8
:CONFigure:SPECtrum:MULTi	6-4
:CONFigure:SPECtrum:SINGLE	6-4
:CONFigure:SUMMary.	6-2
:CONFigure?	13-6
:CONFigure?	6-5

List of Commands, Alphabetical

:DISPlay:WINDow:TRACe:MAXHold OFF ON 0 1	
:DISPlay:WINDow:TRACe:MAXHold?	11-5
:DISPlay:WINDow:TRACe:MAXHold OFF ON 0 1	
:DISPlay:WINDow:TRACe:MAXHold?	12-5
:DISPlay:WINDow:TRACe:Y:ADJust	14-5
:DISPlay:WINDow:TRACe:Y:ADJust	5-24
:DISPlay:WINDow:TRACe:Y:AFPanalyzer:PWR:OFFSet <rel ampl>	
:DISPlay:WINDow:TRACe:Y:AFPanalyzer:PWR:OFFSet?	14-5
:DISPlay:WINDow:TRACe:Y[:SCALe]:AUToscale	4-15
:DISPlay:WINDow:TRACe:Y[:SCALe]:BOTTom <value>	4-15
:DISPlay:WINDow:TRACe:Y[:SCALe]:OFFSet <rel ampl>	
:DISPlay:WINDow:TRACe:Y[:SCALe]:OFFSet?	10-5
:DISPlay:WINDow:TRACe:Y[:SCALe]:OFFSet <rel ampl>	
:DISPlay:WINDow:TRACe:Y[:SCALe]:OFFSet?	11-5
:DISPlay:WINDow:TRACe:Y[:SCALe]:OFFSet <rel ampl>	
:DISPlay:WINDow:TRACe:Y[:SCALe]:OFFSet?	12-5
:DISPlay:WINDow:TRACe:Y[:SCALe]:OFFSet <rel ampl>	
:DISPlay:WINDow:TRACe:Y[:SCALe]:OFFSet?	13-10
:DISPlay:WINDow:TRACe:Y[:SCALe]:OFFSet <rel ampl>	
:DISPlay:WINDow:TRACe:Y[:SCALe]:OFFSet?	6-6
:DISPlay:WINDow:TRACe:Y[:SCALe]:OFFSet <rel ampl>	
:DISPlay:WINDow:TRACe:Y[:SCALe]:OFFSet?	7-7
:DISPlay:WINDow:TRACe:Y[:SCALe]:OFFSet <rel ampl>	
:DISPlay:WINDow:TRACe:Y[:SCALe]:OFFSet?	8-4
:DISPlay:WINDow:TRACe:Y[:SCALe]:OFFSet <rel ampl>	
:DISPlay:WINDow:TRACe:Y[:SCALe]:OFFSet?	9-5
:DISPlay:WINDow:TRACe:Y[:SCALe]:PDIVision <rel ampl>	
:DISPlay:WINDow:TRACe:Y[:SCALe]:PDIVision?	14-5
:DISPlay:WINDow:TRACe:Y[:SCALe]:PDIVision <rel ampl>	
:DISPlay:WINDow:TRACe:Y[:SCALe]:PDIVision?	10-5
:DISPlay:WINDow:TRACe:Y[:SCALe]:PDIVision <rel ampl>	
:DISPlay:WINDow:TRACe:Y[:SCALe]:PDIVision?	13-10
:DISPlay:WINDow:TRACe:Y[:SCALe]:PDIVision <rel ampl>	
:DISPlay:WINDow:TRACe:Y[:SCALe]:PDIVision?	5-24
:DISPlay:WINDow:TRACe:Y[:SCALe]:PDIVision <rel ampl>	
:DISPlay:WINDow:TRACe:Y[:SCALe]:PDIVision?	7-7
:DISPlay:WINDow:TRACe:Y[:SCALe]:PDIVision <rel ampl>	
:DISPlay:WINDow:TRACe:Y[:SCALe]:PDIVision?	8-4
:DISPlay:WINDow:TRACe:Y[:SCALe]:PDIVision <rel ampl>	
:DISPlay:WINDow:TRACe:Y[:SCALe]:PDIVision?	9-5
:DISPlay:WINDow:TRACe:Y[:SCALe]:PDIVision <value>	
:DISPlay:WINDow:TRACe:Y[:SCALe]:PDIVision?	11-6
:DISPlay:WINDow:TRACe:Y[:SCALe]:PDIVision <value>	

:DISPlay:WINDow:TRACe:Y[:SCALe]:PDIVision?	12-6
:DISPlay:WINDow:TRACe:Y[:SCALe]:RLEVel <amplitude>	
:DISPlay:WINDow:TRACe:Y[:SCALe]:RLEVel?	5-24
:DISPlay:WINDow:TRACe:Y[:SCALe]:RLEVel:OFFSet <rel amp >	
:DISPlay:WINDow:TRACe:Y[:SCALe]:RLEVel:OFFSet?	5-25
:DISPlay:WINDow:TRACe:Y[:SCALe]:SMCHart 0 10 20 30 -3	
:DISPlay:WINDow:TRACe:Y[:SCALe]:SMCHart?	4-16
:DISPlay:WINDow:TRACe:Y[:SCALe]:TOP <amplitude>	
:DISPlay:WINDow:TRACe:Y[:SCALe]:TOP?	11-6
:DISPlay:WINDow:TRACe:Y[:SCALe]:TOP <amplitude>	
:DISPlay:WINDow:TRACe:Y[:SCALe]:TOP?	12-6
:DISPlay:WINDow:TRACe:Y[:SCALe]:TOP <value>	4-15
:DISPlay[:WINDow]:TRACe:Y[:SCALe]:RLEVel:AUTO IMMEDIATE	5-25
:FETCh:ACLR?	7-8
:FETCh:ACPower?	5-26
:FETCh:CHPower:CHPower?	5-26
:FETCh:CHPower:DENSity?	5-26
:FETCh:CHPower?	5-27
:FETCh:CHPower?	7-8
:FETCh:DEMod:4x4:TIMEalign?	13-11
:FETCh:DEMod:ACTChannels?	7-9
:FETCh:DEMod:CCPData?	13-11
:FETCh:DEMod:CDPData?	10-6
:FETCh:DEMod:CDPData?	8-5
:FETCh:DEMod:CDPMac?	10-6
:FETCh:DEMod:CDPower?	7-10
:FETCh:DEMod:CDPower?	9-6
:FETCh:DEMod:CFTHrough?	7-10
:FETCh:DEMod:CONStln?	11-7
:FETCh:DEMod:CONStln?	12-7
:FETCh:DEMod:CONStln?	13-12
:FETCh:DEMod:EVM?	7-10
:FETCh:DEMod:EVSCarrier?	11-7
:FETCh:DEMod:EVSCarrier?	12-7
:FETCh:DEMod:EVSYmbol?	11-7
:FETCh:DEMod:EVSYmbol?	12-7
:FETCh:DEMod:FERRor:PPM?	7-11
:FETCh:DEMod:FERRor:PRECise?	7-11
:FETCh:DEMod:FERRor?	7-11
:FETCh:DEMod:HSDPa:FERRor:PPM?	7-12
:FETCh:DEMod:HSDPa:FERRor?	7-12
:FETCh:DEMod:HSDPa:TXFRequency?	7-12
:FETCh:DEMod:NFLoor?	7-13

List of Commands, Alphabetical

:FETCh:DEMod:NUMChannels?	7-13
:FETCh:DEMod:PVRB?	13-12
:FETCh:DEMod:SFLatness?	11-7
:FETCh:DEMod:SFLatness?	12-7
:FETCh:DEMod:SPOWer?	7-13
:FETCh:DEMod:SUMMary?	10-6
:FETCh:DEMod:TIMEalign?	13-12
:FETCh:DEMod:TXFRequency:PRECise?	7-14
:FETCh:DEMod:TXFRequency?	7-14
:FETCh:DEMod?	6-7
:FETCh:EMISsion:FAIL?	7-14
:FETCh:EMISsion:TEMPlate:DATA?	7-15
:FETCh:EMISsion:TEMPlate?	7-15
:FETCh:EMISsion?	7-16
:FETCh:GPS?	3-3
:FETCh:OBWidth:FREQuency?	5-27
:FETCh:OBWidth?	5-27
:FETCh:OBWidth?	7-16
:FETCh:OTA:C4AGGregation?	13-13
:FETCh:OTA:CAGGregation?	13-13
:FETCh:OTA:MAPping?	13-13
:FETCh:OTA:MPATH?	10-7
:FETCh:OTA:MPATH?	9-6
:FETCh:OTA:SCANner?	13-14
:FETCh:OTA:TXTEst?	13-14
:FETCh:OTA?	8-5
:FETCh:OTA{1 2 3 4 5 6}?	7-16
:FETCh:PFail?	10-7
:FETCh:PFail?	11-8
:FETCh:PFail?	12-8
:FETCh:PFail?	6-7
:FETCh:PFail?	7-17
:FETCh:PFail?	9-7
:FETCh:PTAPower?	7-17
:FETCh:PVTFrame?	6-8
:FETCh:PVTSlot?	6-8
:FETCh:RF:ACLR?	13-14
:FETCh:RF:ACPR?	10-8
:FETCh:RF:ACPR?	11-8
:FETCh:RF:ACPR?	12-8
:FETCh:RF:ACPR?	9-7
:FETCh:RF:EMISsion?	10-8
:FETCh:RF:EMISsion?	8-6

:FETCh:RF:EMISsion?	9-8
:FETCh:RF:PVTime?	11-9
:FETCh:RF:PVTime?	12-9
:FETCh:RF:SEM?	13-14
:FETCh:RF:SPECtrum?	10-9
:FETCh:RF:SPECtrum?	11-9
:FETCh:RF:SPECtrum?	12-9
:FETCh:RF:SPECtrum?	13-15
:FETCh:RF:SPECtrum?	8-6
:FETCh:RF:SPECtrum?	9-8
:FETCh:SPECtrum:MULTi?	6-9
:FETCh:SPECtrum:SINGle?	6-9
:FETCh:SUMMary?	13-15
:FETCh:TGENerator:POWStats?	15-3
:FETCh:TGENerator:TXStats?	15-3
:FORMat[:READings][:DATA] ASCii INTeger,32 REAL,[<length>]	
:FORMat[:READings][:DATA]?	14-6
:FORMat[:READings][:DATA] ASCii INTeger,32 REAL,[<length>]	
:FORMat[:READings][:DATA]?	5-28
:FORMat[:READings][:DATA] ASCii INTeger,32 REAL,32	
:FORMat[:READings][:DATA]?	10-10
:FORMat[:READings][:DATA] ASCii INTeger,32 REAL,32	
:FORMat[:READings][:DATA]?	11-10
:FORMat[:READings][:DATA] ASCii INTeger,32 REAL,32	
:FORMat[:READings][:DATA]?	12-10
:FORMat[:READings][:DATA] ASCii INTeger,32 REAL,32	
:FORMat[:READings][:DATA]?	13-16
:FORMat[:READings][:DATA] ASCii INTeger,32 REAL,32	
:FORMat[:READings][:DATA]?	4-17
:FORMat[:READings][:DATA] ASCii INTeger,32 REAL,32	
:FORMat[:READings][:DATA]?	6-10
:FORMat[:READings][:DATA] ASCii INTeger,32 REAL,32	
:FORMat[:READings][:DATA]?	7-18
:FORMat[:READings][:DATA] ASCii INTeger,32 REAL,32	
:FORMat[:READings][:DATA]?	8-7
:FORMat[:READings][:DATA] ASCii INTeger,32 REAL,32	
:FORMat[:READings][:DATA]?	9-9
:GENerator:ADDitional:CALibration.	15-4
:GENerator:OUTput:POWER <amplitude>	
:GENerator:OUTput:POWER?	15-4
:GENerator:OUTput:POWER:OFFSet[:MAGNitude] <value>	
:GENerator:OUTput:POWER:OFFSet[:MAGNitude]?	15-5
:INITiate:CONTinuous OFF ON 0 1	

List of Commands, Alphabetical

:INITiate:CONTInuous?	14-8
:INITiate:CONTInuous OFF ON 0 1	
:INITiate:CONTInuous?	10-11
:INITiate:CONTInuous OFF ON 0 1	
:INITiate:CONTInuous?	11-11
:INITiate:CONTInuous OFF ON 0 1	
:INITiate:CONTInuous?	12-11
:INITiate:CONTInuous OFF ON 0 1	
:INITiate:CONTInuous?	13-17
:INITiate:CONTInuous OFF ON 0 1	
:INITiate:CONTInuous?	4-20
:INITiate:CONTInuous OFF ON 0 1	
:INITiate:CONTInuous?	5-29
:INITiate:CONTInuous OFF ON 0 1	
:INITiate:CONTInuous?	6-11
:INITiate:CONTInuous OFF ON 0 1	
:INITiate:CONTInuous?	7-19
:INITiate:CONTInuous OFF ON 0 1	
:INITiate:CONTInuous?	8-8
:INITiate:CONTInuous OFF ON 0 1	
:INITiate:CONTInuous?	9-10
:INITiate:GENerator OFF ON 0 1	
:INITiate:GENerator?	15-6
:INITiate:HOLD OFF ON 0 1	
:INITiate:HOLD?	4-20
:INITiate:SAVe:ON:EVENt:CROSSsing:LIMit OFF ON 0 1	5-30
:INITiate:SAVe:ON:EVENt:SWEEp OFF ON 0 1	5-30
:INITiate:SAVe:THEn:STOp OFF ON 0 1	5-30
:INITiate[:IMMediate]	10-11
:INITiate[:IMMediate]	11-11
:INITiate[:IMMediate]	12-11
:INITiate[:IMMediate]	13-17
:INITiate[:IMMediate]	4-21
:INITiate[:IMMediate]	5-29
:INITiate[:IMMediate]	6-11
:INITiate[:IMMediate]	7-19
:INITiate[:IMMediate]	8-8
:INITiate[:IMMediate]	9-10
:INITiate[:IMMediate]	14-8
:INSTrument:CATalog:FULL?	3-5
:INSTrument:NSElect <integer>	
:INSTrument:NSElect?	3-5
:INSTrument[:SElect] <string>	

:INSTrument[:SELEct]?	3-6
:MEASure:ACLR?	7-20
:MEASure:ACPower?	5-31
:MEASure:CHPower:CHPower?	5-31
:MEASure:CHPower:DENSity?	5-32
:MEASure:CHPower?	5-32
:MEASure:CHPower?	7-20
:MEASure:DEMod:4x4:TIMEalign?	13-18
:MEASure:DEMod:ACTChannels?	7-21
:MEASure:DEMod:CCPData?	13-18
:MEASure:DEMod:CDPData?	10-12
:MEASure:DEMod:CDPData?	8-9
:MEASure:DEMod:CDPMac?	10-13
:MEASure:DEMod:CDPower?	7-21
:MEASure:DEMod:CDPower?	9-11
:MEASure:DEMod:CFTHrough?	7-22
:MEASure:DEMod:CONStln?	11-12
:MEASure:DEMod:CONStln?	12-12
:MEASure:DEMod:CONStln?	13-19
:MEASure:DEMod:EVM?	7-22
:MEASure:DEMod:EVSCarrier?	11-12
:MEASure:DEMod:EVSCarrier?	12-12
:MEASure:DEMod:EVSYmbol?	11-13
:MEASure:DEMod:EVSYmbol?	12-13
:MEASure:DEMod:FERRor:PPM?	7-22
:MEASure:DEMod:FERRor:PRECise?	7-23
:MEASure:DEMod:FERRor?	7-23
:MEASure:DEMod:HSDPa:FERRor:PPM?	7-24
:MEASure:DEMod:HSDPa:FERRor?	7-24
:MEASure:DEMod:HSDPa:TXFRequency?	7-24
:MEASure:DEMod:NFLoor?	7-25
:MEASure:DEMod:NUMChannels?	7-25
:MEASure:DEMod:SFLatness?	11-13
:MEASure:DEMod:SFLatness?	12-13
:MEASure:DEMod:SPOWER?	7-26
:MEASure:DEMod:SUMMary?	10-13
:MEASure:DEMod:TIMEalign?	13-19
:MEASure:DEMod:TXFRequency:PRECise?	7-26
:MEASure:DEMod:TXFRequency?	7-27
:MEASure:DEMod?	6-12
:MEASure:EMISSion:FAIL?	7-27
:MEASure:EMISSion:TEMPlate:DATA?	7-27
:MEASure:EMISSion:TEMPlate?	7-28

List of Commands, Alphabetical

:MEASure:EMISsion?	7-28
:MEASure:OBWidth?	5-33
:MEASure:OBWidth?	7-29
:MEASure:OTA:C4AGGregation?	13-19
:MEASure:OTA:CAGGregation?	13-20
:MEASure:OTA:MAPping:RUN START STOP	
:MEASure:OTA:MAPping:RUN?	13-20
:MEASure:OTA:MAPping?	13-20
:MEASure:OTA:MPATH?	10-14
:MEASure:OTA:MPATH?	9-12
:MEASure:OTA:SCANner?	13-21
:MEASure:OTA:TXTEst?	13-21
:MEASure:OTA?	8-10
:MEASure:OTA{1 2 3 4 5 6}?	7-30
:MEASure:PFail?	10-14
:MEASure:PFail?	11-14
:MEASure:PFail?	12-14
:MEASure:PFail?	6-13
:MEASure:PFail?	7-30
:MEASure:PFail?	9-12
:MEASure:PTAPower?	7-31
:MEASure:PVTFrame?	6-13
:MEASure:PVTSlot?	6-14
:MEASure:RF:ACLR?	13-21
:MEASure:RF:ACPR?	10-15
:MEASure:RF:ACPR?	11-14
:MEASure:RF:ACPR?	12-14
:MEASure:RF:ACPR?	9-13
:MEASure:RF:EMISsion?	10-16
:MEASure:RF:EMISsion?	8-11
:MEASure:RF:EMISsion?	9-13
:MEASure:RF:PVTime?	11-15
:MEASure:RF:PVTime?	12-15
:MEASure:RF:SEM?	13-22
:MEASure:RF:SPECTrum?	10-16
:MEASure:RF:SPECTrum?	11-15
:MEASure:RF:SPECTrum?	12-15
:MEASure:RF:SPECTrum?	13-22
:MEASure:RF:SPECTrum?	8-12
:MEASure:RF:SPECTrum?	9-15
:MEASure:SPECTrum:MULTi?	6-15
:MEASure:SPECTrum:SINGLE?	6-15
:MEASure:TGENERator:POWStats?	15-7

:MMEMory:DATA? <filename>	5-34
:MMEMory:DELEte <filename>	10-18
:MMEMory:DELEte <filename>	11-16
:MMEMory:DELEte <filename>	12-16
:MMEMory:DELEte <filename>	4-22
:MMEMory:DELEte <filename>	5-34
:MMEMory:DELEte <filename>	6-16
:MMEMory:DELEte <filename>	7-32
:MMEMory:DELEte <filename>	8-13
:MMEMory:DELEte <filename>	9-16
:MMEMory:DELEte <filename>	14-9
:MMEMory:LOAD:LIMit <filename>	5-34
:MMEMory:LOAD:STATe <integer>,<filename>	10-18
:MMEMory:LOAD:STATe <integer>,<filename>	11-16
:MMEMory:LOAD:STATe <integer>,<filename>	12-16
:MMEMory:LOAD:STATe <integer>,<filename>	4-22
:MMEMory:LOAD:STATe <integer>,<filename>	5-35
:MMEMory:LOAD:STATe <integer>,<filename>	6-18
:MMEMory:LOAD:STATe <integer>,<filename>	7-32
:MMEMory:LOAD:STATe <integer>,<filename>	8-13
:MMEMory:LOAD:STATe <integer>,<filename>	9-16
:MMEMory:LOAD:STATe <integer>,<filename>	14-9
:MMEMory:LOAD:TRACe <integer>,<filename>	10-18
:MMEMory:LOAD:TRACe <integer>,<filename>	11-16
:MMEMory:LOAD:TRACe <integer>,<filename>	12-16
:MMEMory:LOAD:TRACe <integer>,<filename>	4-23
:MMEMory:LOAD:TRACe <integer>,<filename>	5-36
:MMEMory:LOAD:TRACe <integer>,<filename>	6-17
:MMEMory:LOAD:TRACe <integer>,<filename>	7-32
:MMEMory:LOAD:TRACe <integer>,<filename>	8-13
:MMEMory:LOAD:TRACe <integer>,<filename>	9-16
:MMEMory:LOAD:TRACe <integer>,<filename>	14-9
:MMEMory:MSIS INTernal USB	
:MMEMory:MSIS?	3-7
:MMEMory:MSIS:COPIY	3-8
:MMEMory:MSIS:DESTInation INTernal USB	
:MMEMory:MSIS:DESTInation?	3-8
:MMEMory:STORe:DATA <file name>	4-24
:MMEMory:STORe:JPEG <filename>	3-9
:MMEMory:STORe:LIMit <filename>	5-37
:MMEMory:STORe:PFail <header><block>	7-33
:MMEMory:STORe:STATe <integer>,<filename>	10-19
:MMEMory:STORe:STATe <integer>,<filename>	11-17

List of Commands, Alphabetical

:MMEMory:STORe:STATe <integer>,<filename>	12-17
:MMEMory:STORe:STATe <integer>,<filename>	4-24
:MMEMory:STORe:STATe <integer>,<filename>	5-37
:MMEMory:STORe:STATe <integer>,<filename>	6-18
:MMEMory:STORe:STATe <integer>,<filename>	7-34
:MMEMory:STORe:STATe <integer>,<filename>	8-14
:MMEMory:STORe:STATe <integer>,<filename>	9-17
:MMEMory:STORe:STATe <integer>,<filename>	14-10
:MMEMory:STORe:TRACe <integer>,<filename>	10-20
:MMEMory:STORe:TRACe <integer>,<filename>	11-18
:MMEMory:STORe:TRACe <integer>,<filename>	12-18
:MMEMory:STORe:TRACe <integer>,<filename>	4-25
:MMEMory:STORe:TRACe <integer>,<filename>	5-37
:MMEMory:STORe:TRACe <integer>,<filename>	6-18
:MMEMory:STORe:TRACe <integer>,<filename>	7-34
:MMEMory:STORe:TRACe <integer>,<filename>	8-15
:MMEMory:STORe:TRACe <integer>,<filename>	9-18
:MMEMory:STORe:TRACe <integer>,<filename>	14-11
:READ:ACLR?	7-35
:READ:ACPower?	5-38
:READ:CHPower:DENSity?	5-38
:READ:CHPower?	5-38
:READ:CHPower?	7-35
:READ:DEMod:4x4:TIMEalign?	13-23
:READ:DEMod:ACTChannels?	7-36
:READ:DEMod:CDPData?	8-16
:READ:DEMod:CDPower?	7-36
:READ:DEMod:CDPower?	9-19
:READ:DEMod:CFTHrough?	7-36
:READ:DEMod:CONStln?	11-19
:READ:DEMod:CONStln?	12-19
:READ:DEMod:CONStln?	13-23
:READ:DEMod:EVM?	7-37
:READ:DEMod:EVSCarrier?	11-19
:READ:DEMod:EVSCarrier?	12-19
:READ:DEMod:EVSYmbol?	11-19
:READ:DEMod:EVSYmbol?	12-19
:READ:DEMod:FERRor:PPM?	7-37
:READ:DEMod:FERRor:PRECise?	7-37
:READ:DEMod:FERRor?	7-37
:READ:DEMod:HSDPa:FERRor:PPM?	7-38
:READ:DEMod:HSDPa:FERRor?	7-38
:READ:DEMod:HSDPa:TXFRequency?	7-38

:READ:DEMod:NFLoor?	7-38
:READ:DEMod:NUMChannels?	7-39
:READ:DEMod:SFLatness?	11-20
:READ:DEMod:SFLatness?	12-20
:READ:DEMod:SPOWer?	7-39
:READ:DEMod:TIMEalign?	13-24
:READ:DEMod:TXFRequency:PRECise?	7-39
:READ:DEMod:TXFRequency?	7-40
:READ:DEMod?	6-20
:READ:EMISsion:FAIL?	7-40
:READ:EMISsion:TEMPlate:DATA?	7-40
:READ:EMISsion:TEMPlate?	7-40
:READ:EMISsion?	7-41
:READ:OBWidth?	5-39
:READ:OBWidth?	7-41
:READ:OTA:C4AGGregation?	13-24
:READ:OTA:CAGGregation?	13-25
:READ:OTA:MAPping?	13-25
:READ:OTA:MPATh?	10-21
:READ:OTA:MPATh?	9-19
:READ:OTA:SCANner?	13-25
:READ:OTA:TXTEst?	13-26
:READ:OTA?	8-17
:READ:OTA{1 2 3 4 5 6}?	7-41
:READ:PFail?	10-21
:READ:PFail?	11-20
:READ:PFail?	12-20
:READ:PFail?	13-26
:READ:PFail?	6-20
:READ:PFail?	7-42
:READ:PFail?	9-20
:READ:PTAPower?	7-42
:READ:PVTFrame?	6-21
:READ:PVTSlot?	6-21
:READ:RF:ACLR?	13-27
:READ:RF:ACPR?	10-22
:READ:RF:ACPR?	11-20
:READ:RF:ACPR?	12-20
:READ:RF:ACPR?	9-20
:READ:RF:EMISsion?	10-22
:READ:RF:EMISsion?	8-17
:READ:RF:EMISsion?	9-21
:READ:RF:PVTTime?	11-21

List of Commands, Alphabetical

:READ:RF:PVTime?	12-21
:READ:RF:PVTSlot?	8-18
:READ:RF:SEM?	13-27
:READ:RF:SPECTrum?	10-23
:READ:RF:SPECTrum?	11-21
:READ:RF:SPECTrum?	12-21
:READ:RF:SPECTrum?	13-27
:READ:RF:SPECTrum?	8-19
:READ:RF:SPECTrum?	9-22
:READ:SPECTrum:MULTi?	6-22
:READ:SPECTrum:SINGLE?	6-22
:READ:TGENerator:POWStats?	15-8
:READ:TGENerator:TXStats?	15-8
:SOURce:POWer LOW HIGH	
:SOURce:POWer?	4-26
:STATus:OPERation?	3-11
:SYSTem:MSIS[:STATe]? INTernal USB	3-12
:SYSTem:OPTions?	3-12
:SYSTem:PRESet	3-12
:TRACe:COpy TRACE1,TRACE2 TRACE3	5-40
:TRACe:EXCHange TRACE2,TRACE3	5-40
:TRACe:PREamble? [1]	4-27
:TRACe:PREamble? {1 2 3}	5-41
:TRACe:PREamble? <trace type>	10-24
:TRACe:PREamble? <trace type>	11-22
:TRACe:PREamble? <trace type>	12-22
:TRACe:PREamble? <trace type>	6-23
:TRACe:PREamble? <trace type>	7-43
:TRACe:PREamble? <trace type>	8-20
:TRACe:PREamble? <trace type>	9-23
:TRACe[:DATA] {1 2 3},(<header><block>)	
:TRACe[:DATA]? {1 2 3}	5-41
:TRACe[:DATA] ACLR SPECTrum EMISSion DEMod,(<header><block>)	
:TRACe[:DATA]? ACLR SPECTrum EMISSion DEMod	7-43
:TRACe[:DATA]? [1]	4-27
:TRACe[:DATA]? <trace type>	10-25
:TRACe[:DATA]? <trace type>	11-22
:TRACe[:DATA]? <trace type>	12-22
:TRACe[:DATA]? <trace type>	6-23
:TRACe[:DATA]? <trace type>	8-21
:TRACe[:DATA]? <trace type>	9-24
:TRACe[:DATA]?	14-12
:TRACe{1 2 3}:DISPlay[:STATe] OFF ON 0 1	

:TRACe{1 2 3}:DISPlay[:STATe]?	5-42
:TRACe{1 2 3}:LOAD:DISPlay[:STATe] OFF ON 0 1	
:TRACe{1 2 3}:LOAD:DISPlay[:STATe]?	5-43
:TRACe{1 2 3}:WRITe[:STATe] OFF ON 0 1	
:TRACe{1 2 3}:WRITe[:STATe]?	5-43
:TRACe1:OPERation NORMAl MAXHold MINHold AVERAge	
:TRACe1:OPERation?	5-44
:TRACe2:OPERation MAXHold MINHold	
:TRACe2:OPERation?	5-44
:TRACe3:OPERation MAXHold MINHold A-B B-A	
:TRACe3:OPERation?	5-45
:TRIGger:SEQuence:SLOPe RISing FALLing	
:TRIGger:SEQuence:SLOPe?	10-27
:TRIGger:SEQuence:SLOPe RISing FALLing	
:TRIGger:SEQuence:SLOPe?	9-26
:TRIGger[:SEQuence]:SOURce IMMEDIATE EXTernal VIDeo	
:TRIGger[:SEQuence]:SOURce?	5-46
:TRIGger[:SEQuence]:VIDeo:DELay <percentage> or <time>	
:TRIGger[:SEQuence]:VIDeo:DELay?	5-47
:TRIGger[:SEQuence]:VIDeo:LEVel <amplitude>	
:TRIGger[:SEQuence]:VIDeo:LEVel?	5-46
:UNIT:POWEr DBM DBV DBMV DBUV V W DBW A DBA WCM2	
:UNIT:POWEr?	5-48
:UNIT:POWEr DBM W	
:UNIT:POWEr?	10-28
:UNIT:POWEr DBM W	
:UNIT:POWEr?	13-28
:UNIT:POWEr DBM W	
:UNIT:POWEr?	8-23
:UNIT:POWEr DBM W	
:UNIT:POWEr?	9-27
[:SENSe]:4TAE:ACTive OFF ON	
[:SENSe]:4TAE:ACTive?	13-29
[:SENSe]:ACPower:BANDwidth:MAIN <freq>	
[:SENSe]:ACPower:BANDwidth:MAIN?	10-29
[:SENSe]:ACPower:BANDwidth:MAIN <freq>	
[:SENSe]:ACPower:BANDwidth:MAIN?	9-28
[:SENSe]:ACPower:BANDwidth BWIDth:ADJacent <freq>	
[:SENSe]:ACPower:BANDwidth BWIDth:ADJacent?	5-49
[:SENSe]:ACPower:BANDwidth BWIDth:MAIN <freq>	
[:SENSe]:ACPower:BANDwidth BWIDth:MAIN?	5-49
[:SENSe]:ACPower:BANDwidth BWIDth:SPACing <freq>	
[:SENSe]:ACPower:BANDwidth BWIDth:SPACing?	5-49

List of Commands, Alphabetical

[[:SENSe]:ACPower:STATe OFF ON 0 1	
[[:SENSe]:ACPower:STATe?	5-50
[[:SENSe]:AFPanalyzer:AVERAge:COUNT <avg count>	
[[:SENSe]:AFPanalyzer:AVERAge:COUNT?	14-13
[[:SENSe]:AFPanalyzer:DEMod:DATA?	14-13
[[:SENSe]:AFPanalyzer:DEMod:MODE RFSP AFSP AFWV SUMMArY	
[[:SENSe]:AFPanalyzer:DEMod:MODE?	14-13
[[:SENSe]:AFPanalyzer:DEMod:TYPE AM FM PM	
[[:SENSe]:AFPanalyzer:DEMod:TYPE?	14-14
[[:SENSe]:AFPanalyzer:FM:SCALe <percentage>	
[[:SENSe]:AFPanalyzer:FM:SCALe?	14-14
[[:SENSe]:AFPanalyzer:IFBW <freq>	
[[:SENSe]:AFPanalyzer:IFBW?	14-14
[[:SENSe]:AFPanalyzer:IFBW:AUTO 0 1	
[[:SENSe]:AFPanalyzer:IFBW:AUTO?	14-15
[[:SENSe]:AFPanalyzer:PM:SCALe <Radians>	
[[:SENSe]:AFPanalyzer:PM:SCALe?	14-15
[[:SENSe]:AFPanalyzer:RFSPectrum:DATA?	14-15
[[:SENSe]:AFPanalyzer:SPAN <freq>	
[[:SENSe]:AFPanalyzer:SPAN?	14-16
[[:SENSe]:AFPanalyzer:SUMMArY:DATA?	14-16
[[:SENSe]:AFPanalyzer:SWEEp:TIME <time>	
[[:SENSe]:AFPanalyzer:SWEEp:TIME?	14-16
[[:SENSe]:AVERAge:CLear	4-28
[[:SENSe]:AVERAge:COUNT <integer>	
[[:SENSe]:AVERAge:COUNT?	4-28
[[:SENSe]:AVERAge:COUNT <integer>	
[[:SENSe]:AVERAge:COUNT?	5-50
[[:SENSe]:AVERAge:FERRor OFF ON 0 1	
[[:SENSe]:AVERAge:FERRor?	7-45
[[:SENSe]:AVERAge:FERRor:COUNT <integer>	
[[:SENSe]:AVERAge:FERRor:COUNT?	7-45
[[:SENSe]:AVERAge:TYPE NONE SCALAr MAXimum MINimum	
[[:SENSe]:AVERAge:TYPE?	5-51
[[:SENSe]:AVERAge[:STATe] OFF ON 0 1	
[[:SENSe]:AVERAge[:STATe]?	4-28
[[:SENSe]:BANDWidth[:RESolution] 1.4 3 5 10 15 20	
[[:SENSe]:BANDWidth[:RESolution]?	13-29
[[:SENSe]:BANDwidth BWIDth:VIDeo <freq>	
[[:SENSe]:BANDwidth BWIDth:VIDeo?	5-51
[[:SENSe]:BANDwidth BWIDth:VIDeo:AUTO OFF ON 0 1	
[[:SENSe]:BANDwidth BWIDth:VIDeo:AUTO?	5-52
[[:SENSe]:BANDwidth BWIDth:VIDeo:RATio <number>	

[:SENSE]:BANDwidth BWIDth:VIDeo:RATio?	5-52
[:SENSE]:BANDwidth BWIDth[:RESolution] <freq>	
[:SENSE]:BANDwidth BWIDth[:RESolution]?	5-53
[:SENSE]:BANDwidth BWIDth[:RESolution] <index>	
[:SENSE]:BANDwidth BWIDth[:RESolution]?	11-24
[:SENSE]:BANDwidth BWIDth[:RESolution] <index>	
[:SENSE]:BANDwidth BWIDth[:RESolution]?	12-24
[:SENSE]:BANDwidth BWIDth[:RESolution]:AUTO OFF ON 0 1	
[:SENSE]:BANDwidth BWIDth[:RESolution]:AUTO?	5-53
[:SENSE]:BANDwidth BWIDth[:RESolution]:RATio <number>	
[:SENSE]:BANDwidth BWIDth[:RESolution]:RATio?	5-54
[:SENSE]:CC {1 2 3 4 5}:ACTive OFF ON	
[:SENSE]:CC {1 2 3 4 5}:ACTive?	13-29
[:SENSE]:CC {1 2 3 4 5}:BANDWidth 1.4 3 5 10 15 20	
[:SENSE]:CC {1 2 3 4 5}:BANDWidth?	13-30
[:SENSE]:CC {1 2 3 4 5}:CHANnel <number>	
[:SENSE]:CC {1 2 3 4 5}:CHANnel?	13-30
[:SENSE]:CC {1 2 3 4 5}:FREQuency <freq>	
[:SENSE]:CC {1 2 3 4 5}:FREQuency?	13-30
[:SENSE]:CC {1 2 3 4 5}:SIGStandard <string>	
[:SENSE]:CC {1 2 3 4 5}:SIGStandard?	13-30
[:SENSE]:CELLID <char>	
[:SENSE]:CELLID?	13-31
[:SENSE]:CHPower:BANDwidth BWIDth:INTegration <freq>	
[:SENSE]:CHPower:BANDwidth BWIDth:INTegration?	5-54
[:SENSE]:CHPower:STATe OFF ON 0 1	
[:SENSE]:CHPower:STATe?	5-54
[:SENSE]:CORRection:COLLect:ABORt	4-29
[:SENSE]:CORRection:COLLect:INITialize	4-29
[:SENSE]:CORRection:COLLect:LOAD	4-29
[:SENSE]:CORRection:COLLect:OPEN	4-30
[:SENSE]:CORRection:COLLect:SHORt.	4-30
[:SENSE]:CORRection:COLLect:STATus? [INITialize OPEN SHORt LOAD] . . .	4-31
[:SENSE]:CORRection:IMPedance[:INPut]:OFFSet <rel amp>	
[:SENSE]:CORRection:IMPedance[:INPut]:OFFSet?	5-55
[:SENSE]:CORRection:IMPedance[:INPut][:MAGNitude] <integer>	
[:SENSE]:CORRection:IMPedance[:INPut][:MAGNitude]?	5-55
[:SENSE]:CORRection:INSTacal:CALibrate	4-31
[:SENSE]:CORRection:TYPE STANDARD FLEX	
[:SENSE]:CORRection:TYPE?	4-31
[:SENSE]:CPRatio <index>	
[:SENSE]:CPRatio?	11-24
[:SENSE]:CW:FREQuency	

List of Commands, Alphabetical

[[:SENSE]:CW:FREQuency?	15-9
[[:SENSE]:DEMod:CDPData:UNITs RELative ABSolute	
[[:SENSE]:DEMod:CDPData:UNITs?	8-24
[[:SENSE]:DEMod:CDPower:UNITs RELative ABSolute	
[[:SENSE]:DEMod:CDPower:UNITs?	10-29
[[:SENSE]:DEMod:CDPower:UNITs RELative ABSolute	
[[:SENSE]:DEMod:CDPower:UNITs?	9-28
[[:SENSE]:DEMod:CDPower:ZOOM 16 32 64	
[[:SENSE]:DEMod:CDPower:ZOOM?.	10-30
[[:SENSE]:DEMod:CDPower:ZOOM 16 32 64	
[[:SENSE]:DEMod:CDPower:ZOOM?.	9-29
[[:SENSE]:DEMod:CDPower:ZOOM:STARt <integer>	
[[:SENSE]:DEMod:CDPower:ZOOM:STARt?	10-30
[[:SENSE]:DEMod:CDPower:ZOOM:STARt <integer>	
[[:SENSE]:DEMod:CDPower:ZOOM:STARt?	9-29
[[:SENSE]:DEMod:CODogram:TIME <seconds>	
[[:SENSE]:DEMod:CODogram:TIME?	7-46
[[:SENSE]:DEMod:CONStln:POINts?	11-25
[[:SENSE]:DEMod:CONStln:REFPoints[:STATe] OFF ON 0 1	
[[:SENSE]:DEMod:CONStln:REFPoints[:STATe]?	11-25
[[:SENSE]:DEMod:CONStln:REFPoints[:STATe] OFF ON 0 1	
[[:SENSE]:DEMod:CONStln:REFPoints[:STATe]?	12-24
[[:SENSE]:DEMod:CPICH:ABSolute?	7-46
[[:SENSE]:DEMod:CPICH:RELative?	7-46
[[:SENSE]:DEMod:CTRLchannels:UNIT RELative ABSolute DELta	
[[:SENSE]:DEMod:CTRLchannels:UNIT?	7-46
[[:SENSE]:DEMod:EVSCarrier:STARt:X?	11-25
[[:SENSE]:DEMod:EVSCarrier:STOP:X?	11-25
[[:SENSE]:DEMod:EVSYmbol:STARt:X?	11-25
[[:SENSE]:DEMod:EVSYmbol:STOP:X?	11-25
[[:SENSE]:DEMod:HSDPa:IQPersistence <integer>	
[[:SENSE]:DEMod:HSDPa:IQPersistence?	7-47
[[:SENSE]:DEMod:HSDPa:TIME <seconds>	
[[:SENSE]:DEMod:HSDPa:TIME?	7-47
[[:SENSE]:DEMod:MODType Auto QPSK 8PSK 16QAM	
[[:SENSE]:DEMod:MODType?	8-24
[[:SENSE]:DEMod:MUSer Auto 2-16 (even)	
[[:SENSE]:DEMod:MUSer?	8-24
[[:SENSE]:DEMod:PCCPch:RELative?	7-47
[[:SENSE]:DEMod:PCDError?	7-47
[[:SENSE]:DEMod:PICH:CODE <code number>	
[[:SENSE]:DEMod:PICH:CODE?	7-48
[[:SENSE]:DEMod:SCCPch:CODE <code number>	

[:SENSe]:DEMod:SCCPch:CODE?	7-48
[:SENSe]:DEMod:SCCPch:SFACTOR 4 8 16 32 64 128 256	
[:SENSe]:DEMod:SCCPch:SFACTOR?	7-48
[:SENSe]:DEMod:SCODE <scrambling code>	
[:SENSe]:DEMod:SCODE?	7-49
[:SENSe]:DEMod:SCODE:AUTO OFF ON 0 1	
[:SENSe]:DEMod:SCODE:AUTO?	7-49
[:SENSe]:DEMod:SCRamblingcode Auto 0-127	
[:SENSe]:DEMod:SCRamblingcode?.	8-25
[:SENSe]:DEMod:SFACTOR 256 512	
[:SENSe]:DEMod:SFACTOR?	7-49
[:SENSe]:DEMod:SFLatness:START:X?	11-26
[:SENSe]:DEMod:SFLatness:STOP:X?	11-26
[:SENSe]:DEMod:SPRFactor Auto 16 1	
[:SENSe]:DEMod:SPRFactor?	8-25
[:SENSe]:DEMod:THRShold <rel ampl>	
[:SENSe]:DEMod:THRShold?	7-50
[:SENSe]:DEMod:THRShold:AUTO OFF ON 0 1	
[:SENSe]:DEMod:THRShold:AUTO?	7-50
[:SENSe]:DETECTOR[:FUNCTION] POSitive RMS NEGative SAMPLE	
[:SENSe]:DETECTOR[:FUNCTION]?	5-56
[:SENSe]:DLFLength 2.5 5 10	
[:SENSe]:DLFLength?	11-26
[:SENSe]:DWPTs Auto On Off	
[:SENSe]:DWPTs?	8-25
[:SENSe]:EMF:STATE OFF ON 0 1	
[:SENSe]:EMF:STATE?	13-31
[:SENSe]:EMF:STATE OFF ON 0 1	
[:SENSe]:EMF:STATE?	5-56
[:SENSe]:ENhanced:CALibration:COMplete[:STATE]?	15-10
[:SENSe]:EVM:MODE AUTO PBCHonly	
[:SENSe]:EVM:MODE?	13-32
[:SENSe]:EXTRefstatus?	5-56
[:SENSe]:FREQuency:BAND AUTO GSM EDGE	
[:SENSe]:FREQuency:BAND?.	6-24
[:SENSe]:FREQuency:CABLe <index>	4-32
[:SENSe]:FREQuency:CENTer <freq>	
[:SENSe]:FREQuency:CENTer?	14-17
[:SENSe]:FREQuency:CENTer <freq>	
[:SENSe]:FREQuency:CENTer?	10-30
[:SENSe]:FREQuency:CENTer <freq>	
[:SENSe]:FREQuency:CENTer?	11-26
[:SENSe]:FREQuency:CENTer <freq>	

List of Commands, Alphabetical

[[:SENSE]:FREQUENCY:CENTER?	12-25
[[:SENSE]:FREQUENCY:CENTER <freq>	
[[:SENSE]:FREQUENCY:CENTER?	13-32
[[:SENSE]:FREQUENCY:CENTER <freq>	
[[:SENSE]:FREQUENCY:CENTER?	5-57
[[:SENSE]:FREQUENCY:CENTER <freq>	
[[:SENSE]:FREQUENCY:CENTER?	6-24
[[:SENSE]:FREQUENCY:CENTER <freq>	
[[:SENSE]:FREQUENCY:CENTER?	7-50
[[:SENSE]:FREQUENCY:CENTER <freq>	
[[:SENSE]:FREQUENCY:CENTER?	8-26
[[:SENSE]:FREQUENCY:CENTER <freq>	
[[:SENSE]:FREQUENCY:CENTER?	9-29
[[:SENSE]:FREQUENCY:LINK UPLINK DOWNLINK UPANDDOWNLINK	
[[:SENSE]:FREQUENCY:LINK?	4-32
[[:SENSE]:FREQUENCY:SIGSTANDARD:CHANNEL <number>	
[[:SENSE]:FREQUENCY:SIGSTANDARD:CHANNEL?	14-17
[[:SENSE]:FREQUENCY:SIGSTANDARD:CHANNEL <number>	
[[:SENSE]:FREQUENCY:SIGSTANDARD:CHANNEL?	10-31
[[:SENSE]:FREQUENCY:SIGSTANDARD:CHANNEL <number>	
[[:SENSE]:FREQUENCY:SIGSTANDARD:CHANNEL?	11-27
[[:SENSE]:FREQUENCY:SIGSTANDARD:CHANNEL <number>	
[[:SENSE]:FREQUENCY:SIGSTANDARD:CHANNEL?	12-25
[[:SENSE]:FREQUENCY:SIGSTANDARD:CHANNEL <number>	
[[:SENSE]:FREQUENCY:SIGSTANDARD:CHANNEL?	13-32
[[:SENSE]:FREQUENCY:SIGSTANDARD:CHANNEL <number>	
[[:SENSE]:FREQUENCY:SIGSTANDARD:CHANNEL?	5-57
[[:SENSE]:FREQUENCY:SIGSTANDARD:CHANNEL <number>	
[[:SENSE]:FREQUENCY:SIGSTANDARD:CHANNEL?	6-24
[[:SENSE]:FREQUENCY:SIGSTANDARD:CHANNEL <number>	
[[:SENSE]:FREQUENCY:SIGSTANDARD:CHANNEL?	7-51
[[:SENSE]:FREQUENCY:SIGSTANDARD:CHANNEL <number>	
[[:SENSE]:FREQUENCY:SIGSTANDARD:CHANNEL?	8-26
[[:SENSE]:FREQUENCY:SIGSTANDARD:CHANNEL <number>	
[[:SENSE]:FREQUENCY:SIGSTANDARD:CHANNEL?	9-30
[[:SENSE]:FREQUENCY:SIGSTANDARD:NAME [String]	
[[:SENSE]:FREQUENCY:SIGSTANDARD:NAME?	13-32
[[:SENSE]:FREQUENCY:SIGSTANDARD:NAME <string>	
[[:SENSE]:FREQUENCY:SIGSTANDARD:NAME?	14-17
[[:SENSE]:FREQUENCY:SIGSTANDARD:NAME <string>	
[[:SENSE]:FREQUENCY:SIGSTANDARD:NAME?	10-31
[[:SENSE]:FREQUENCY:SIGSTANDARD:NAME <string>	
[[:SENSE]:FREQUENCY:SIGSTANDARD:NAME?	11-27

[:SENSe]:FREQuency:SIGStandard:NAME <string>	
[:SENSe]:FREQuency:SIGStandard:NAME?	12-25
[:SENSe]:FREQuency:SIGStandard:NAME <string>	
[:SENSe]:FREQuency:SIGStandard:NAME?	4-32
[:SENSe]:FREQuency:SIGStandard:NAME <string>	
[:SENSe]:FREQuency:SIGStandard:NAME?	5-57
[:SENSe]:FREQuency:SIGStandard:NAME <string>	
[:SENSe]:FREQuency:SIGStandard:NAME?	6-25
[:SENSe]:FREQuency:SIGStandard:NAME <string>	
[:SENSe]:FREQuency:SIGStandard:NAME?	7-51
[:SENSe]:FREQuency:SIGStandard:NAME <string>	
[:SENSe]:FREQuency:SIGStandard:NAME?	8-26
[:SENSe]:FREQuency:SIGStandard:NAME <string>	
[:SENSe]:FREQuency:SIGStandard:NAME?	9-30
[:SENSe]:FREQuency:SPAN <freq>	
[:SENSe]:FREQuency:SPAN?	14-18
[:SENSe]:FREQuency:SPAN <freq>	
[:SENSe]:FREQuency:SPAN?	5-58
[:SENSe]:FREQuency:SPAN:FULL	5-58
[:SENSe]:FREQuency:SPAN:FULL	14-18
[:SENSe]:FREQuency:SPAN:MINimum	14-18
[:SENSe]:FREQuency:SPAN:PREVious	5-58
[:SENSe]:FREQuency:SPAN:PREVious	14-18
[:SENSe]:FREQuency:SPAN?	10-31
[:SENSe]:FREQuency:SPAN?	9-30
[:SENSe]:FREQuency:START <freq>	
[:SENSe]:FREQuency:START?	4-33
[:SENSe]:FREQuency:START <freq>	
[:SENSe]:FREQuency:START?	5-58
[:SENSe]:FREQuency:START?	6-25
[:SENSe]:FREQuency:START?	7-51
[:SENSe]:FREQuency:STEP[:INCRement] <freq>	
[:SENSe]:FREQuency:STEP[:INCRement]?	14-18
[:SENSe]:FREQuency:STEP[:INCRement] <freq>	
[:SENSe]:FREQuency:STEP[:INCRement]?	5-59
[:SENSe]:FREQuency:STOP <freq>	
[:SENSe]:FREQuency:STOP?	4-33
[:SENSe]:FREQuency:STOP <freq>	
[:SENSe]:FREQuency:STOP?	5-59
[:SENSe]:FREQuency:STOP?	6-25
[:SENSe]:FREQuency:STOP?	7-51
[:SENSe]:FSTRength:ANTenna <antenna>	
[:SENSe]:FSTRength:ANTenna?	5-59

List of Commands, Alphabetical

[[:SENSE]:FSTReNght:STATe OFF ON 0 1	
[[:SENSE]:FSTReNght:STATe?	5-60
[[:SENSE]:GENERator:ENhanced:CALibratIon[:STATe] OFF ON 0 1	
[[:SENSE]:GENERator:ENhanced:CALibratIon[:STATe]?	15-10
[[:SENSE]:GENERator:MODE CW TRACKing	
[[:SENSE]:GENERator:MODE?	15-9
[[:SENSE]:GPS ON OFF 1 0	
[[:SENSE]:GPS?	3-10
[[:SENSE]:GPS:CURRent?	3-10
[[:SENSE]:GPS:RESet	3-10
[[:SENSE]:GPS:VOLTage 0 1	
[[:SENSE]:GPS:VOLTage?	3-10
[[:SENSE]:LTE:STATUs?	13-33
[[:SENSE]:MATChing:PADS 0 1 2	
[[:SENSE]:MATChing:PADS?	15-11
[[:SENSE]:NUMCarriers 1 3	
[[:SENSE]:NUMCarriers?	8-27
[[:SENSE]:OBWidth:METHod XDB PERCent	
[[:SENSE]:OBWidth:METHod?	14-19
[[:SENSE]:OBWidth:METHod XDB PERCent	
[[:SENSE]:OBWidth:METHod?	5-60
[[:SENSE]:OBWidth:PERCent <percentage>	
[[:SENSE]:OBWidth:PERCent?	14-19
[[:SENSE]:OBWidth:PERCent <percentage>	
[[:SENSE]:OBWidth:PERCent?	5-61
[[:SENSE]:OBWidth:STATe OFF ON 0 1	
[[:SENSE]:OBWidth:STATe?	5-61
[[:SENSE]:OBWidth:XDB <rel ampl>	
[[:SENSE]:OBWidth:XDB?	14-20
[[:SENSE]:OBWidth:XDB <rel ampl>	
[[:SENSE]:OBWidth:XDB?	5-61
[[:SENSE]:OPTion:IF:BWState 1 2 3 4 5	
[[:SENSE]:OPTion:IF:BWState?	5-62
[[:SENSE]:OTA:RESet	7-52
[[:SENSE]:OTA:SCODE:AUTO OFF ON 0 1	
[[:SENSE]:OTA:SCODE:AUTO?	7-52
[[:SENSE]:OTA:SCODE:LOCK OFF ON 0 1	
[[:SENSE]:OTA:SCODE:LOCK?	7-53
[[:SENSE]:OTA:SCODE{1 2 3 4 5 6}<scrambling code>	
[[:SENSE]:OTA:SCODE{1 2 3 4 5 6}?	7-53
[[:SENSE]:OTA:SORT CODE POWER	
[[:SENSE]:OTA:SORT?	7-54
[[:SENSE]:PFail <test set>	

[:SENSe]:PFail?	10-32
[:SENSe]:PFail <test set>	
[:SENSe]:PFail?	11-27
[:SENSe]:PFail <test set>	
[:SENSe]:PFail?	12-26
[:SENSe]:PFail <test set>	
[:SENSe]:PFail?	6-26
[:SENSe]:PFail <test set>	
[:SENSe]:PFail?	7-54
[:SENSe]:PFail <test set>	
[:SENSe]:PFail?	8-27
[:SENSe]:PFail <test set>	
[:SENSe]:PFail?	9-31
[:SENSe]:PN:OFFSet <integer>	
[:SENSe]:PN:OFFSet?	10-32
[:SENSe]:PN:OFFSet <integer>	
[:SENSe]:PN:OFFSet?	9-31
[:SENSe]:PN:STYPe:AUTO 1 0 ON OFF	
[:SENSe]:PN:STYPe:AUTO?	10-33
[:SENSe]:PN:STYPe:AUTO 1 0 ON OFF	
[:SENSe]:PN:STYPe:AUTO?	9-32
[:SENSe]:PN:TRIGger NOTRig GPS EXT	
[:SENSe]:PN:TRIGger?	10-33
[:SENSe]:PN:TRIGger NOTRig GPS EXT	
[:SENSe]:PN:TRIGger?	9-32
[:SENSe]:POWer[:RF]:ATTenuation <rel ampl>	
[:SENSe]:POWer[:RF]:ATTenuation?	5-62
[:SENSe]:POWer[:RF]:ATTenuation:AUTO OFF ON 0 1	
[:SENSe]:POWer[:RF]:ATTenuation:AUTO?	5-63
[:SENSe]:POWer[:RF]:GAIN[:STATe] OFF ON 0 1	
[:SENSe]:POWer[:RF]:GAIN[:STATe]?	5-64
[:SENSe]:POWer[:RF]:RANGe:AUTO <Boolean (default=1 [ON])>	
[:SENSe]:POWer[:RF]:RANGe:AUTO?	13-33
[:SENSe]:POWer[:RF]:RANGe:AUTO OFF ON 0 1	
[:SENSe]:POWer[:RF]:RANGe:AUTO?	10-34
[:SENSe]:POWer[:RF]:RANGe:AUTO OFF ON 0 1	
[:SENSe]:POWer[:RF]:RANGe:AUTO?	11-28
[:SENSe]:POWer[:RF]:RANGe:AUTO OFF ON 0 1	
[:SENSe]:POWer[:RF]:RANGe:AUTO?	12-26
[:SENSe]:POWer[:RF]:RANGe:AUTO OFF ON 0 1	
[:SENSe]:POWer[:RF]:RANGe:AUTO?	6-26
[:SENSe]:POWer[:RF]:RANGe:AUTO OFF ON 0 1	
[:SENSe]:POWer[:RF]:RANGe:AUTO?	7-55

List of Commands, Alphabetical

[[:SENSE]:POWER[:RF]:RANGE:AUTO OFF ON 0 1	
[[:SENSE]:POWER[:RF]:RANGE:AUTO?	8-28
[[:SENSE]:POWER[:RF]:RANGE:AUTO OFF ON 0 1	
[[:SENSE]:POWER[:RF]:RANGE:AUTO?	9-33
[[:SENSE]:POWER[:RF]:RANGE[:IMMEDIATE]	10-34
[[:SENSE]:POWER[:RF]:RANGE[:IMMEDIATE]	11-28
[[:SENSE]:POWER[:RF]:RANGE[:IMMEDIATE]	12-27
[[:SENSE]:POWER[:RF]:RANGE[:IMMEDIATE]	13-33
[[:SENSE]:POWER[:RF]:RANGE[:IMMEDIATE]	6-27
[[:SENSE]:POWER[:RF]:RANGE[:IMMEDIATE]	7-55
[[:SENSE]:POWER[:RF]:RANGE[:IMMEDIATE]	8-28
[[:SENSE]:POWER[:RF]:RANGE[:IMMEDIATE]	9-33
[[:SENSE]:PVTFrame:START?	6-27
[[:SENSE]:PVTFrame:STOP?	6-27
[[:SENSE]:PVTSlot:START?	6-27
[[:SENSE]:PVTSlot:STOP?	6-27
[[:SENSE]:RF:ACLR:ADJCchannelcount <num of channels>	
[[:SENSE]:RF:ACLR:ADJCchannelcount?	7-55
[[:SENSE]:RF:ACLR:MAINchannelcount <num of main channels>	
[[:SENSE]:RF:ACLR:MAINchannelcount?	7-56
[[:SENSE]:RF:ACPR:ADJCchannelcount?	11-28
[[:SENSE]:RF:ACPR:MAINchannelcount <integer>	
[[:SENSE]:RF:ACPR:MAINchannelcount?	10-34
[[:SENSE]:RF:ACPR:MAINchannelcount <integer>	
[[:SENSE]:RF:ACPR:MAINchannelcount?	9-33
[[:SENSE]:RF:ACPR:MAINchannelcount?	11-29
[[:SENSE]:RF:PVTime:FRAME:START?	11-29
[[:SENSE]:RF:PVTime:FRAME:STOP?	11-29
[[:SENSE]:RF:SPECTrum:SPAN 5 10 20 30	
[[:SENSE]:RF:SPECTrum:SPAN?	11-29
[[:SENSE]:RF:SPECTrum:SPAN 5 10 20 30	
[[:SENSE]:RF:SPECTrum:SPAN?	12-27
[[:SENSE]:RF:SPECTrum:SPAN Auto 1.4 3 5 10 15 20 30	
[[:SENSE]:RF:SPECTrum:SPAN?	13-34
[[:SENSE]:SLOTselection Auto 0-6	
[[:SENSE]:SLOTselection?	8-28
[[:SENSE]:SWEep:MODE FAST PERFORMANCE NOFFt	
[[:SENSE]:SWEep:MODE?	5-64
[[:SENSE]:SWEep:RESolution LOW MEDIUM HIGH 1102 2204	
[[:SENSE]:SWEep:RESolution?	4-34
[[:SENSE]:SWEep:RFIMmunity 0 1	
[[:SENSE]:SWEep:RFIMmunity?	4-34
[[:SENSE]:SWEep:SPEEd FAST NORM SLOW	

[:SENSe]:SWEep:SPEEd?	10-35
[:SENSe]:SWEep:SPEEd FAST NORM SLOW	
[:SENSe]:SWEep:SPEEd?	8-29
[:SENSe]:SWEep:SPEEd FAST NORM SLOW	
[:SENSe]:SWEep:SPEEd?	9-34
[:SENSe]:SWEep:STATus?	5-64
[:SENSe]:SWEep:TIME:ACTual?	5-65
[:SENSe]:SWEep:TIME:AUTO ON OFF 1 0	
[:SENSe]:SWEep:TIME:AUTO?	5-65
[:SENSe]:SWEep:TIME[:LLIMit]	
[:SENSe]:SWEep:TIME[:LLIMit]?	5-65
[:SENSe]:SWEep:TRACe?	5-65
[:SENSe]:SYDLcode Auto 0-31	
[:SENSe]:SYDLcode?	8-29
[:SENSe]:SYNC:TYPE SS RS	
[:SENSe]:SYNC:TYPE?	13-34
[:SENSe]:TAE:ACTive OFF ON	
[:SENSe]:TAE:ACTive?	13-34
[:SENSe]:TAU:OFFSet <integer>	
[:SENSe]:TAU:OFFSet?	8-29
[:SENSe]:TGENERator:POWStats[:STATe] OFF ON 0 1	
[:SENSe]:TGENERator:POWStats[:STATe]?	15-11
[:SENSe]:TGENERator:TX:NORMALize[:STATe] OFF ON 0 1	
[:SENSe]:TGENERator:TX:NORMALize[:STATe]?	15-12
[:SENSe]:TGENERator:TX[:SCALE]:PDIVision <rel ampl>	
[:SENSe]:TGENERator:TX[:SCALE]:PDIVision?	15-12
[:SENSe]:TGENERator:TX[:SCALE]:RLEVel <amplitude>	
[:SENSe]:TGENERator:TX[:SCALE]:RLEVel?	15-13
[:SENSe]:TGENERator:TX[:SCALE]:RLEVel:OFFSet <rel ampl>	
[:SENSe]:TGENERator:TX[:SCALE]:RLEVel:OFFSet?	15-13
[:SENSe]:TGENERator:TXStats[:STATe] OFF ON 0 1	
[:SENSe]:TGENERator:TXStats[:STATe]?	15-13
[:SENSe]:TRIGger NOTRig GPS EXT	
[:SENSe]:TRIGger?	8-30
[:SENSe]:ULSWitchpoint 0-6	
[:SENSe]:ULSWitchpoint?	8-30
[:SENSe]:WCODe 64 128	
[:SENSe]:WCODe?	10-35
[:SENSe]:WCODe 64 128	
[:SENSe]:WCODe?	9-34
MMEM:DIR?	3-7

Anritsu



10580-00256



V



Anritsu utilizes recycled paper and environmentally conscious inks and toner.

Anritsu Company
490 Jarvis Drive
Morgan Hill, CA 95037-2809
USA

<http://www.anritsu.com>